

DESCRIPTION: M12 MALE - BOARD MOUNT - 5 POS.

NOTE:

MATERIAL  
 HOUSING: PBT UL94V-0, BLACK  
 CONTACT: BRASS  
 SHELL: BRASS  
 NUT: BRASS  
 O-RING A: EPDM, BLACK  
 O-RING B: NBR

FINISH  
 CONTACT: GOLD PLATED  
 OVER 50µ" NICKEL  
 SHELL: NICKEL PLATED  
 NUT: NICKEL PLATED

ELECTRICAL  
 RATED CURRENT: 4A  
 RATED VOLTAGE: 60V  
 INSULATION RESISTANCE: 100 MΩhms MIN.  
 CONTACT RESISTANCE: 10 mΩhms MAX.  
 WATER PROOF: IP67

ENVIRONMENT  
 OPERATION TEMPERATURE: -40°C TO +85°C

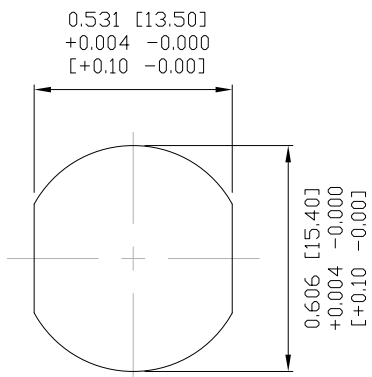

PANEL CUTOUT

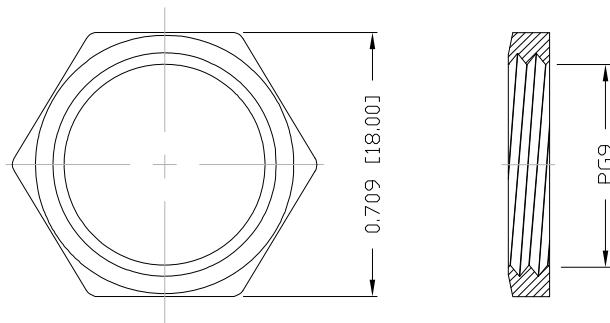

NUT

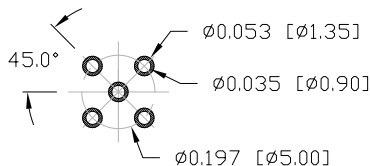

PCB LAYOUT

860-005-113R00Y

3 = BRASS/NICKEL SHELL & NUT  
 S = STAINLESS STEEL SHELL & NUT

1 = GOLD FLASH  
 4 = 10µ" GOLD

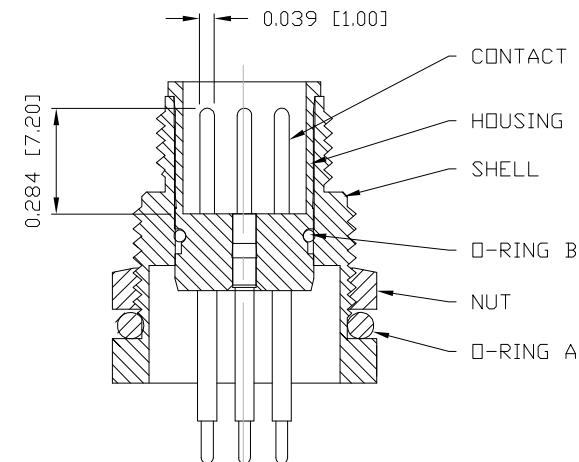
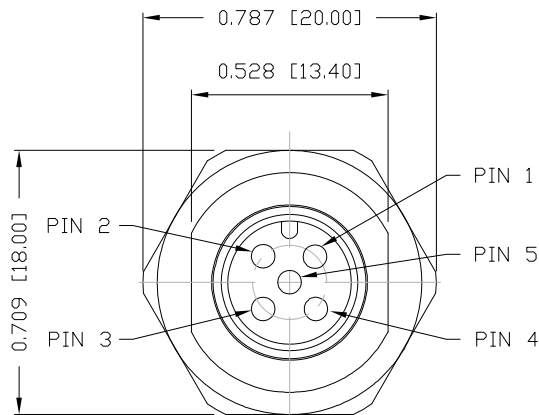
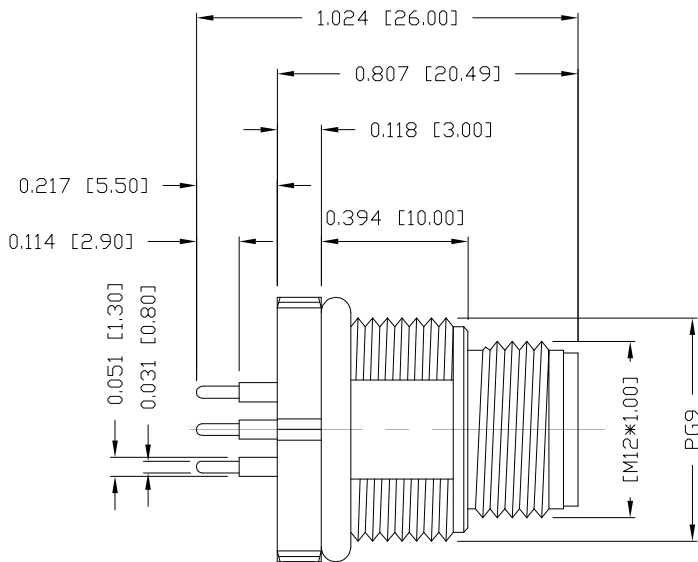

RoHS COMPLIANT

UNITS = INCHES [MM]

DO NOT SCALE FROM DRAWING



THESE DRAWINGS AND SPECIFICATIONS ARE THE PROPERTY OF NorComp AND SHALL NOT BE REPRODUCED, COPIED OR USED AS THE BASIS FOR THE MANUFACTURE OR SALE OF APPARATUS WITHOUT WRITTEN PERMISSION.

DRAWN: M. SIGMON

DATE: 03-07-16

NorComp

SCALE: NTS

SHEET 1 OF 1

REV 3

DWG NO. 860-005-113R00Y