

THIS IS A C.A.D. GENERATED DRAWING
DO NOT MAKE MANUAL REVISIONS TO MASTER.

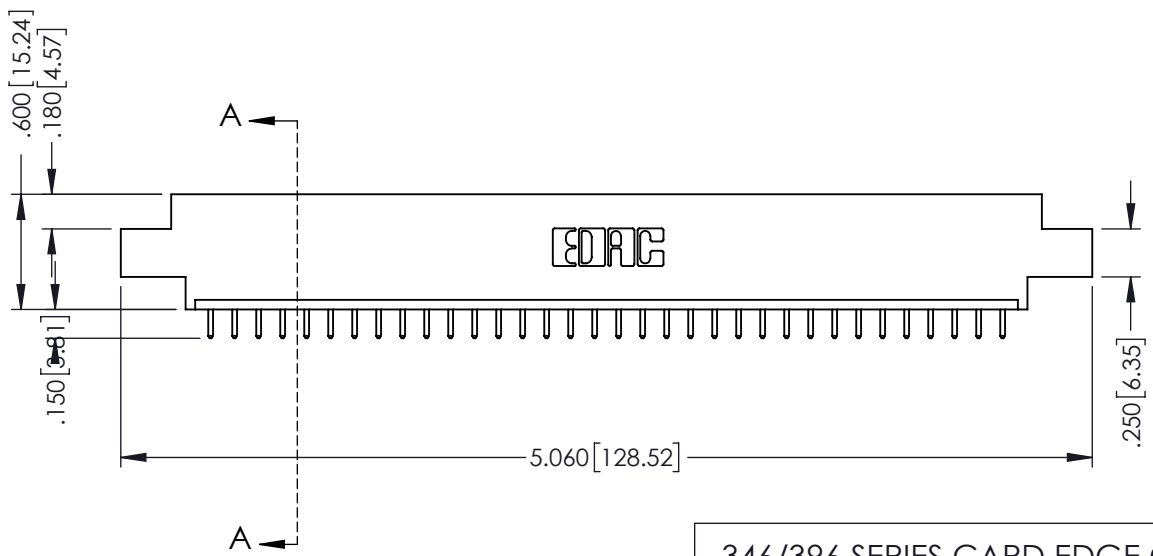

ISSUE NUMBER	
ORIGINAL	①

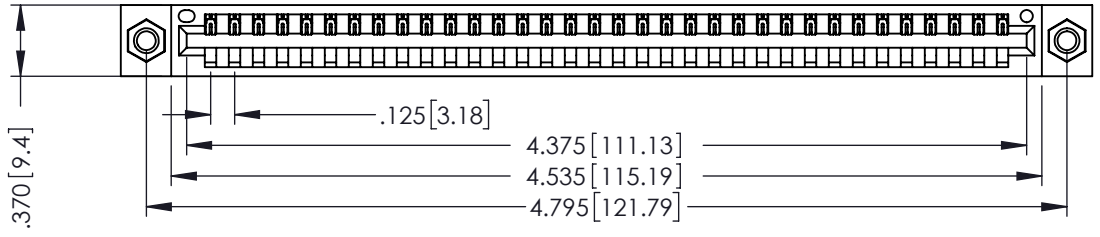

SECTION A-A

- INSULATOR MATERIAL: THERMOPLASTIC POLYESTER, UL 94V-0
- CONTACT MATERIAL: COPPER, NICKEL, TIN ALLOY CA-725
- CONTACT PLATING: GOLD ON THE MATING AREA, TIN-LEAD ON THE CONTACT TAILS, NICKEL UNDERPLATE

346/396 SERIES CARD EDGE CONNECTOR
PART NUMBER: 346-034-521-607

 EDAC INC TORONTO, ONTARIO CANADA YOUR CONNECTION TO QUALITY & SERVICE	THESE DRAWINGS AND SPECIFICATIONS ARE THE PROPERTY OF EDAC INC. AND SHALL NOT BE REPRODUCED, OR COPIED OR USED AS THE BASIS FOR THE MANUFACTURE OR SALE OF APPARATUS WITHOUT WRITTEN PERMISSION.																	
	<table border="1"> <tr> <td>ACAD REFERENCE NO.</td> <td>346-ENG-MASTER</td> </tr> <tr> <td>DRAWN:</td> <td>J.LEE</td> </tr> <tr> <td>CHECKED:</td> <td></td> </tr> <tr> <td>SCALE:</td> <td>1:1</td> </tr> <tr> <td>DRAWING NUMBER</td> <td>346-ENG-MASTER</td> </tr> <tr> <td>DATE:</td> <td>APR. 22/09</td> </tr> <tr> <td></td> <td>DATE:</td> </tr> <tr> <td></td> <td>SHEET 1 OF 2</td> </tr> <tr> <td>ISSUE</td> <td>1</td> </tr> </table>	ACAD REFERENCE NO.	346-ENG-MASTER	DRAWN:	J.LEE	CHECKED:		SCALE:	1:1	DRAWING NUMBER	346-ENG-MASTER	DATE:	APR. 22/09		DATE:		SHEET 1 OF 2	ISSUE
ACAD REFERENCE NO.	346-ENG-MASTER																	
DRAWN:	J.LEE																	
CHECKED:																		
SCALE:	1:1																	
DRAWING NUMBER	346-ENG-MASTER																	
DATE:	APR. 22/09																	
	DATE:																	
	SHEET 1 OF 2																	
ISSUE	1																	

Contact Description:
555-Extender Board Bend (Code 500 Contacts)

THIS IS A C.A.D. GENERATED DRAWING
 DO NOT MAKE MANUAL REVISIONS TO MASTER.



ISSUE NUMBER	
ORIGINAL	①



Contact Code 555



Contact Code 556



Contact Code 558



Contact Code 559



Contact Code 560

- INSULATOR MATERIAL: THERMOPLASTIC POLYESTER, UL 94V-0
- CONTACT MATERIAL; COPPER, NICKEL, TIN ALLOY CA-725
- CONTACT PLATING: GOLD ON THE MATING AREA, TIN-LEAD ON THE CONTACT TAILS, NICKEL UNDERPLATE

**346/396 SERIES CARD EDGE CONNECTOR
 CONTACT CODE 555,556,558,559,560 DIMENSIONS**



EDAC INC
 TORONTO, ONTARIO
 CANADA

YOUR CONNECTION TO QUALITY & SERVICE

THESE DRAWINGS AND SPECIFICATIONS
 ARE THE PROPERTY OF EDAC INC. AND
 SHALL NOT BE REPRODUCED, OR COPIED
 OR USED AS THE BASIS FOR THE
 MANUFACTURE OR SALE OF APPARATUS
 WITHOUT WRITTEN PERMISSION.

ACAD REFERENCE NO.	346-ENG-MASTER	
DRAWN:	J.LEE	DATE: APR. 22/09
CHECKED:	DATE:	
SCALE:	1:1	SHEET 2 OF 2
DRAWING NUMBER	346-ENG-MASTER	ISSUE 1