



Apr. 2021 Ver.1.5
TDK Corporation

Multilayer Triplexer

For JB-MB-HB / 5G-LM / 5GHz Triplexer

TPX Series 2.5x2.0mm [EIA 1008] TYPE

P/N: **TPX255925MT-7062B1**

TPX255925MT-7062B1

SHAPES AND DIMENSIONS

[Top View]

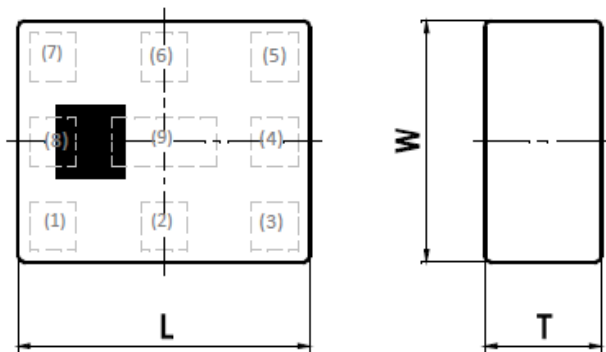

[Bottom View]

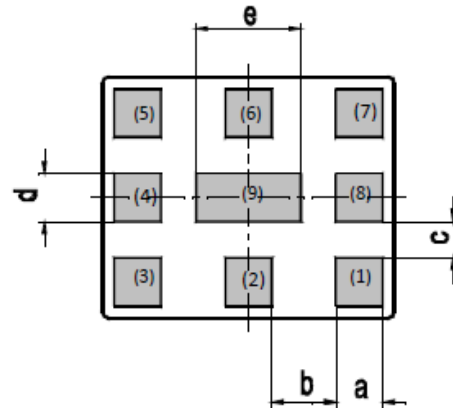

Dimensions (mm)

L	W	T	a	b	c	d	e
2.50	2.00	0.65	0.40	0.55	0.30	0.40	0.90
+/-0.15	+/-0.15	Max	+/-0.10	+/-0.10	+/-0.10	+/-0.10	+/-0.15

Terminal functions

(1)	Common Port
(2)	GND
(3)	5GHz
(4)	GND
(5)	5G-LM

(6)	GND
(7)	JB-MB-HB
(8)	GND
(9)	GND

TERMINATION FINISH

Material
Ag

TPX255925MT-7062B1

■ ELECTRICAL CHARACTERISTICS

(Measurement)

Low-Band

Parameter	Frequency (MHz)	TDK Spec.		
		Min.	Typ.	Max.
Insertion Loss (dB)	617 to 960	-	0.13	0.50
	1166 to 1186	-	0.14	0.50
	1427 to 1511	-	0.21	0.50
	1559 to 1563	-	0.22	0.50
	1574 to 1576	-	0.22	0.50
	1598 to 1606	-	0.22	0.50
	1710 to 1785	-	0.23	0.50
	1805 to 1885	-	0.23	0.50
	1930 to 1990	-	0.24	0.50
	2300 to 2496	-	0.48	0.60
	2496 to 2690	-	0.79	0.95
Insertion Loss (dB) (-40 to +90 °C)	617 to 960	-	-	0.55
	1166 to 1186	-	-	0.55
	1427 to 1511	-	-	0.55
	1559 to 1563	-	-	0.55
	1574 to 1576	-	-	0.55
	1598 to 1606	-	-	0.55
	1710 to 1785	-	-	0.55
	1805 to 1885	-	-	0.55
	1930 to 1990	-	-	0.55
	2300 to 2496	-	-	0.70
	2496 to 2690	-	-	1.05
Return Loss (dB) (Low-Band Port)	617 to 2690	10	20	-
Attenuation (dB)	3300 to 3700	16	19	-
	3700 to 3800	22	32	-
	3800 to 4200	22	32	-
	4400 to 5000	28	30	-
	5150 to 5925	26	28	-
	5925 to 12750	10	18	-
Characteristic Impedance (ohm)		50 (Nominal)		

Ta = +25+/-5°C

TPX255925MT-7062B1

■ ELECTRICAL CHARACTERISTICS

(Measurement)

Middle-Band

Parameter	Frequency (MHz)	TDK Spec.		
		Min.	Typ.	Max.
Insertion Loss (dB)	3300 to 4200	-	1.29	1.48
Insertion Loss (dB) (-40 to +90 °C)	3300 to 4200	-	-	1.60
Return Loss (dB) (Middle-Band Port)	3300 to 4200	10	15.9	-
Attenuation (dB)	500 to 1606	22	28	-
	1606 to 2400	25	28	-
	2400 to 2500	25	27	-
	2500 to 2690	25	27	-
	2700 to 3150	0.5	2.3	-
	4400 to 4900	1	2.0	-
	4900 to 5150	8	14	-
	5150 to 5925	19	20	-
	6250 to 6550	15	37	-
	6600 to 8400	15	37	-
	8400 to 9900	20	41	-
9900 to 12600	20	38	-	
13200 to 16800	20	-	-	
Characteristic Impedance (ohm)		50 (Nominal)		

Ta = +25+/-5°C

High-Band

Parameter	Frequency (MHz)	TDK Spec.		
		Min.	Typ.	Max.
Insertion Loss (dB)	5150 to 5925	-	0.75	0.85
Insertion Loss (dB) (-40 to +90 °C)	5150 to 5925	-	-	0.95
Return Loss (dB) (High-Band Port)	5150 to 5925	12	18.0	-
Attenuation (dB)	100 to 960	35	59.0	-
	1166 to 1249	35	54.0	-
	1427 to 1610	35	51.0	-
	1695 to 2200	25	47.0	-
	2300 to 2370	25	45.0	-
	2400 to 2484	25	43.0	-
	2496 to 2690	29	37.0	-
	3300 to 4200	17	26.0	-
	10300 to 11850	15	39.0	-
	15450 to 17775	8	-	-
Characteristic Impedance (ohm)		50 (Nominal)		

Ta = +25+/-5°C

TPX255925MT-7062B1

■ ELECTRICAL CHARACTERIST

(Measurement)

Common

Parameter	Frequency (MHz)	TDK Spec.		
		Min.	Typ.	Max.
Isolation (dB)				
Middle to Low (JB-MB-HB to 5G-LM)	617 to 960	22	28	-
	1166 to 1606	22	29	-
	1695 to 1710	25	32	-
	1710 to 2200	25	34	-
	2300 to 2690	23	25	-
	3300 to 4200	17	19	-
High to Low (JB-MB-HB to 5 GHz)	5150 to 5925	30	47	-
	617 to 960	25	57	-
	1166 to 1606	25	49	-
	1695 to 1710	25	49	-
	1710 to 2690	25	41	-
	3300 to 4200	22	37	-
Middle to High (5G-LM to 5 GHz)	5150 to 5925	28	29	-
	617 to 960	10	37	-
	1166 to 1606	10	32	-
	1710 to 2690	10	22	-
	3300 to 4200	17	18	-
5150 to 5925	17	21	-	
Characteristic Impedance (ohm)		50 (Nominal)		

Ta = +25+/-5°C

■ MAXIMUM RATINGS

Parameter	TDK Spec	Conditions	
			Min.
Operating temperature (°C)	-40 to +90 °C		
Storage temperature (°C)	-40 to +90 °C		
Power Handling (dBm) *1	Frequency [MHz]		
	1427 to 2960	- 30	CW
	3300 to 4200	- 30	CW
	5150 to 5925	- 30	CW
Human Body Model : HBM @Each Port (V)	-1000 1000	100pF / 1500ohm	
Machine Model : MM @Each Port (V)	-150 150	200pF / 0ohm	
Charged Device Model : CDM @Each Port (V)	-500 500	Relative humidity : 60%RH max	

*1: Refer to 3GPP TS 38.101-1 V15.2.0

TPX255925MT-7062B1

FREQUENCY CHARACTERISTICS

■ TDK spec.

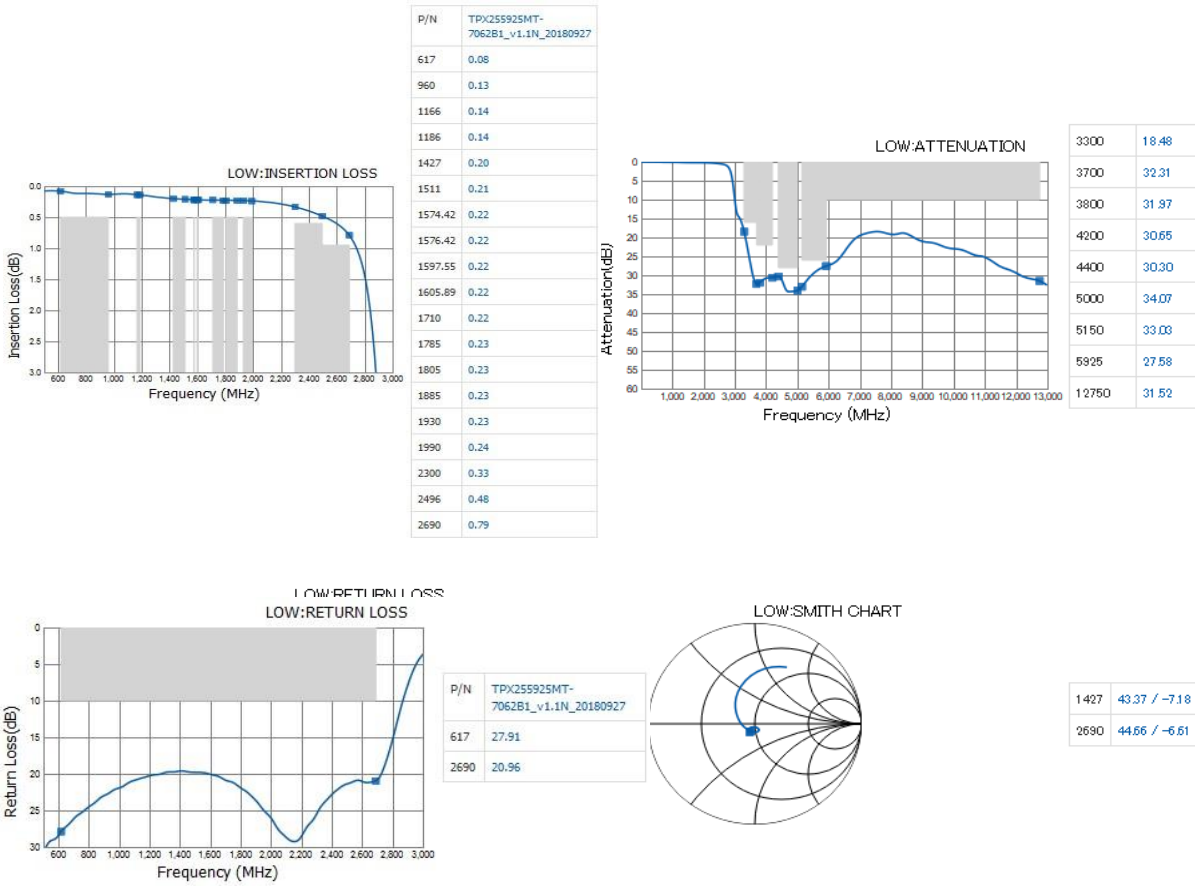

TPX255925MT-7062B1

FREQUENCY CHARACTERISTICS

■ TDK spec.

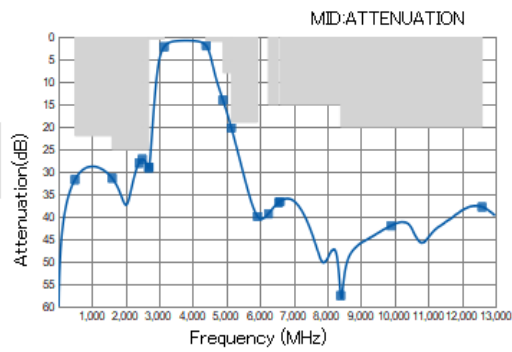
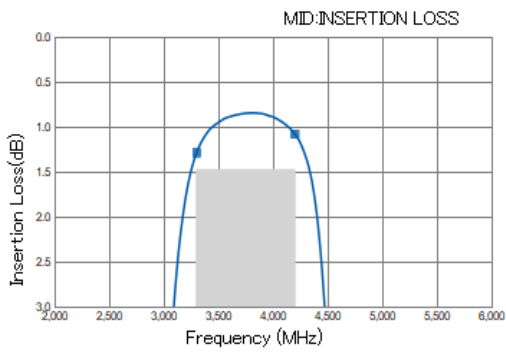

500	31.78
1606	31.44
2400	28.11
2500	27.21
2690	29.12
2700	28.99
3150	2.23
4400	1.96
4900	14.06
5150	20.26
5925	39.92
6250	39.34
6550	36.88
6600	36.60
8400	57.56
9900	42.00
12600	37.85

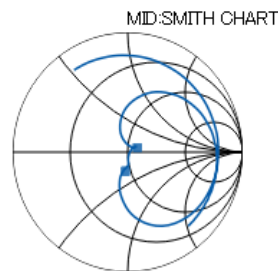
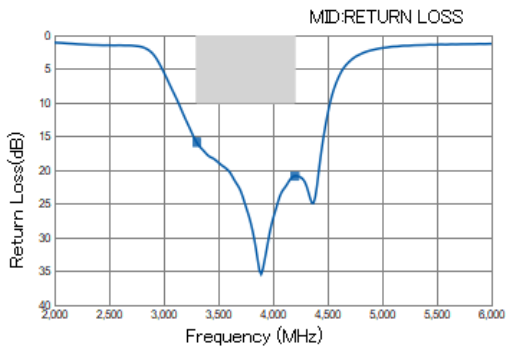

3300	44.46 / -14.38
4200	57.87 / 5.84

TPX255925MT-7062B1

FREQUENCY CHARACTERISTICS

TDK spec.

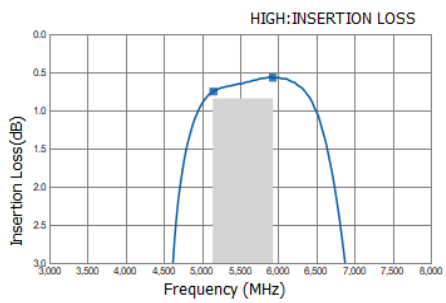

P/N	TPX255925MT-7062B1_v1.1N_20180927
5150	0.75
5925	0.57

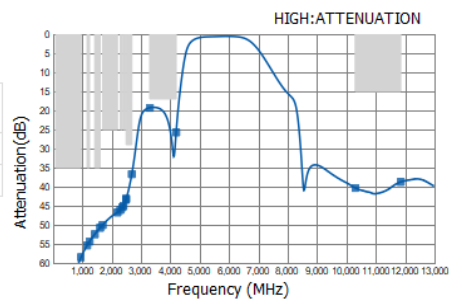

P/N	TPX255925MT-7062B1_v1.1N_20180927
100	83.16
960	58.49
1166	55.39
1249	54.35
1427	52.47
1610	50.77
1695	50.05
2200	46.75
2300	46.09
2370	45.39
2400	45.00
2484	43.43
2496	43.14
2690	36.70
3300	19.29
4200	25.76
10300	40.30
11850	38.74

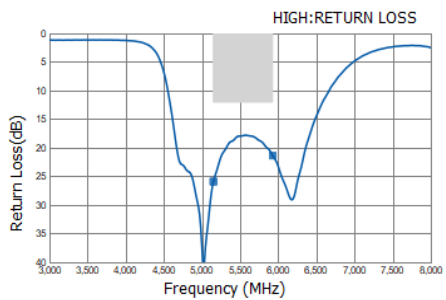

P/N	TPX255925MT-7062B1_v1.1N_20180927
5150	25.90
5925	21.32

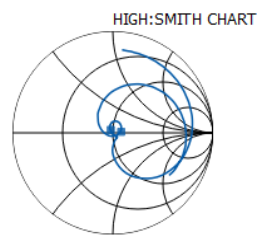

P/N	TPX255925MT-7062B1_v1.1N_20180927
5150	46.9 / 3.81
5925	59.08 / 2.3

TPX255925MT-7062B1

FREQUENCY CHARACTERISTICS

TDK spec.

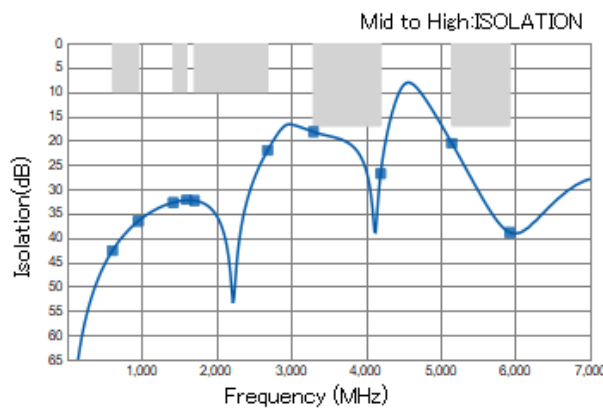
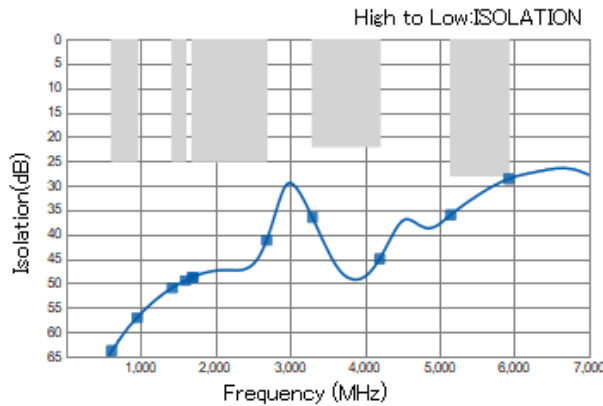
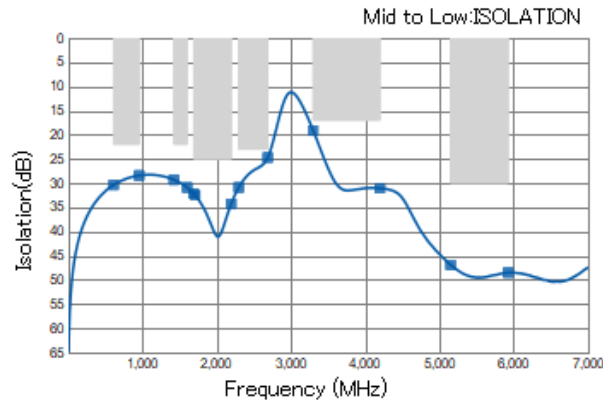

617	30.36
960	28.42
1427	29.29
1606	30.91
1695	32.20
1710	32.46
2200	34.24
2300	30.90
2690	24.71
3300	19.07
4200	31.08
5150	46.87
5925	48.50

617	63.82
960	57.04
1427	50.94
1606	49.40
1695	48.79
1710	48.69
2690	41.18
3300	36.52
4200	45.01
5150	36.02
5925	28.64

617	42.59
960	36.59
1427	32.75
1606	32.29
1710	32.36
2690	22.00
3300	18.22
4200	26.79
5150	20.52
5925	38.90

Apr. 2021 Ver.1.5
TDK Corporation

TPX255925MT-7062B1

RECOMMENDED LAND PATTERN

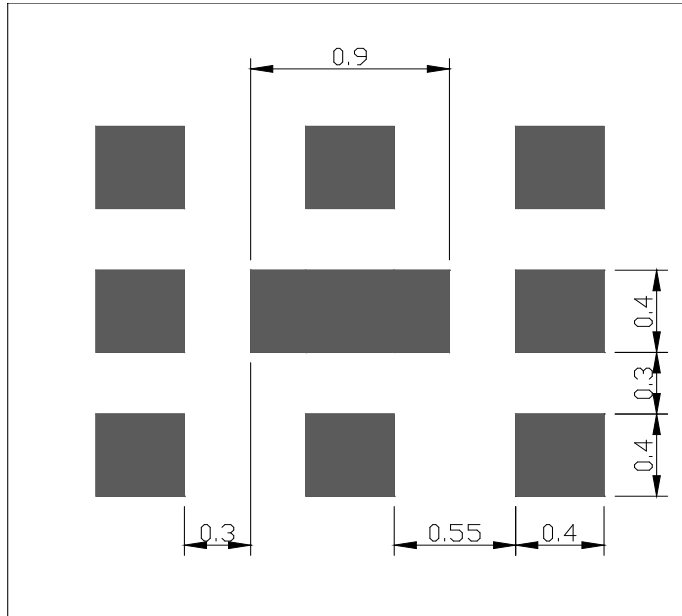

EVALUATION BOARD

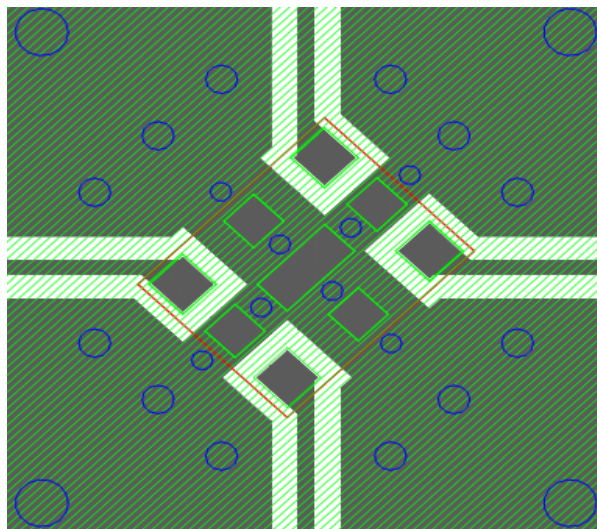

- Thru Hole
- Resist
- Surface Pattern
- DUT
- Direction Mark

Material, Layer	Thickness
Top Resist	Resist
Copper Surface Pattern	0.035mm
FR-4	0.10mm
Copper Inner GND	0.018mm
FR-4	0.30mm
Copper Bottom GND	0.035mm

ENVIRONMENT INFORMATION

RoHS Statement
RoHS Compliance

All specifications are subject to change without notice.
TDK Technology - Proprietary and Confidential Information of TDK Group Companies

TPX255925MT-7062B1

RECOMMENDED REFLOW PROFILE

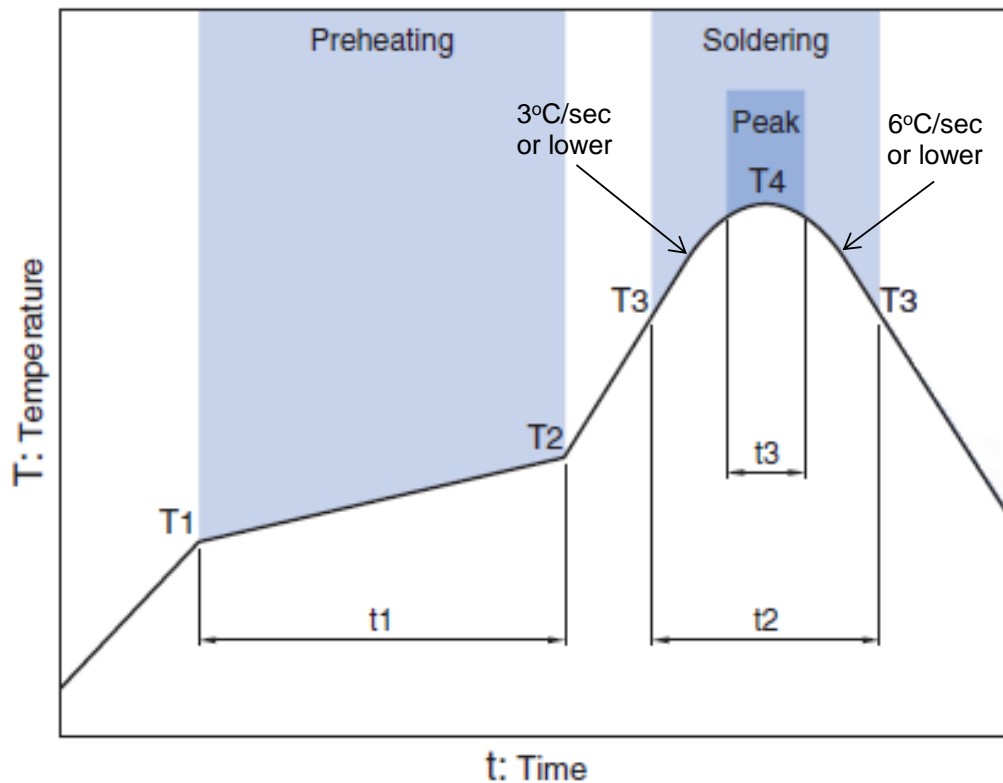

Preheating			Soldering			
Temp.		Time	Critical zone (T3 to T4)		Peak	
T1	T2	t1	T3	t2	T4	t3 *
150°C	200°C	60 to 120sec	217°C	60 to 120sec	240 to 260°C	30 sec Max

* t3 : Time within 5°C of actual peak temperature

The maximum number of reflow is 3.

Note: Lead free solder is recommended.
Recommended solder is Sn-3.0Ag-0.5Cu. (M705 by Senju Metal Industry)

TPX255925MT-7062B1**PACKAGING STYLE**

Reel Dimensions

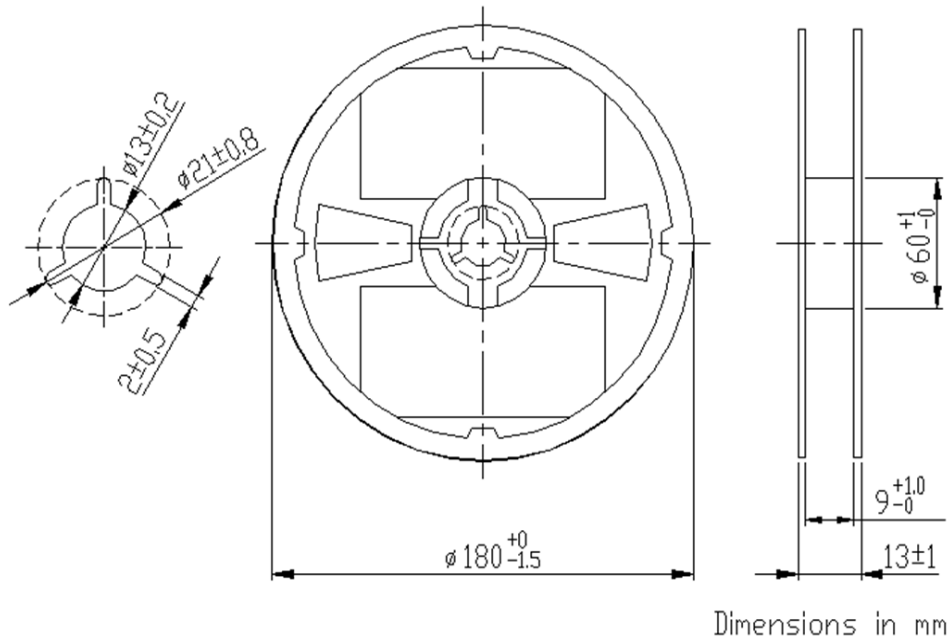

Carrier Tape

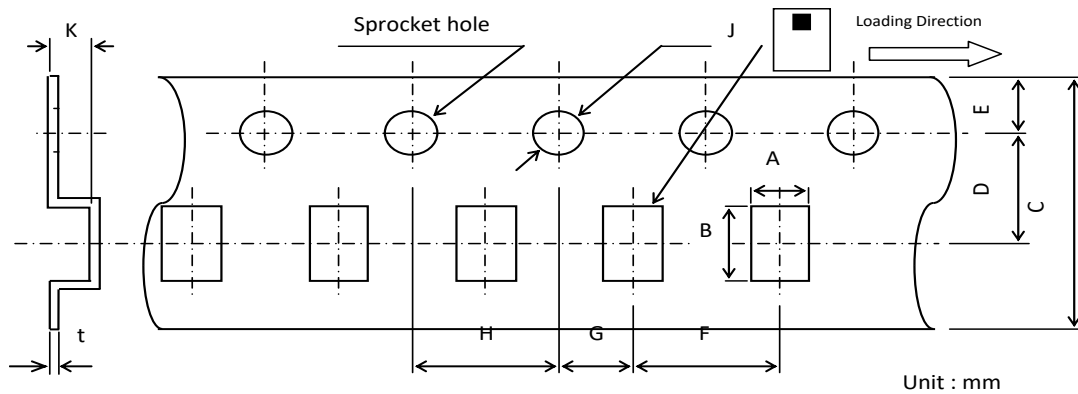

Dimensions (mm)

A	B	C	D	E	F	G	H	J	K	t
2.2	2.7	8.0	3.5	1.75	4.0	2.0	4.0	1.5	0.85	0.25
± 0.05	± 0.05	$\pm 0.3/\pm 0.1$	± 0.05	± 0.1	± 0.1	± 0.05	± 0.1	$\pm 0.1/\pm 0$	MAX	± 0.05

STANDARD PACKAGE QUANTITY (pieces/reel)
2,000

REMINDERS FOR USING THESE PRODUCTS

Before using these products, be sure to request the delivery specifications.

SAFETY REMINDERS

Please pay sufficient attention to the warnings for safe designing when using these products.

REMINDERS

The products listed on this specification sheet are intended for use in general electronic equipment (AV equipment, telecommunications equipment, home appliances, amusement equipment, computer equipment, personal equipment, office equipment, measurement equipment, industrial robots) under a normal operation and use condition.

The products are not designed or warranted to meet the requirements of the applications listed below, whose performance and/or quality require a more stringent level of safety or reliability, or whose failure, malfunction or trouble could cause serious damage to society, person or property. Please understand that we are not responsible for any damage or liability caused by use of the products in any of the applications below or for any other use exceeding the range or conditions set forth in this specification sheet.

1. Aerospace/Aviation equipment
2. Transportation equipment (cars, electric trains, ships, etc.)
3. Medical equipment
4. Power-generation control equipment
5. Atomic energy-related equipment
6. Seabed equipment
7. Transportation control equipment
8. Public information-processing equipment
9. Military equipment
10. Electric heating apparatus, burning equipment
11. Disaster prevention/crime prevention equipment
12. Safety equipment
13. Other applications that are not considered general-purpose applications

When using this product in general-purpose applications, you are kindly requested to take into consideration securing protection circuit/equipment or providing backup circuits, etc., to ensure higher safety.