

APPROVED: _____
 DATE: _____ TITLE: _____

Rev	AWO #	Description	Date	Appr
-		RELEASED	9/24/20	
A		UPDATE DRAWING.	5/11/21	JJ/RC
B		ADDED DRAWING.	8/9/21	WX/RC

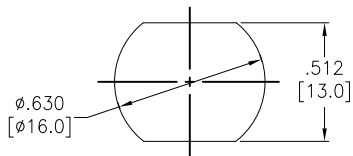

RECOMMENDED
 PANEL CUT-OUT

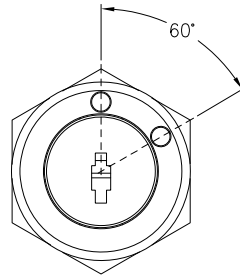
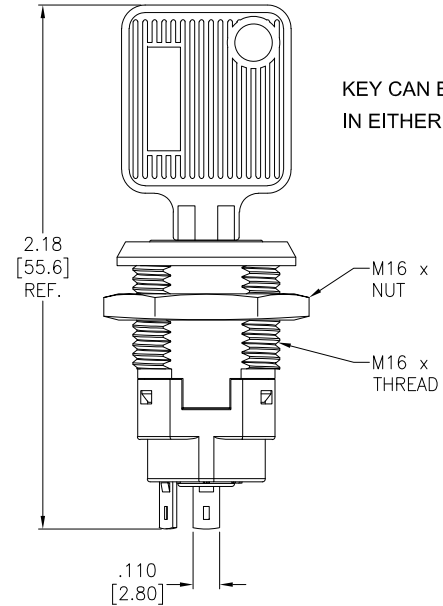
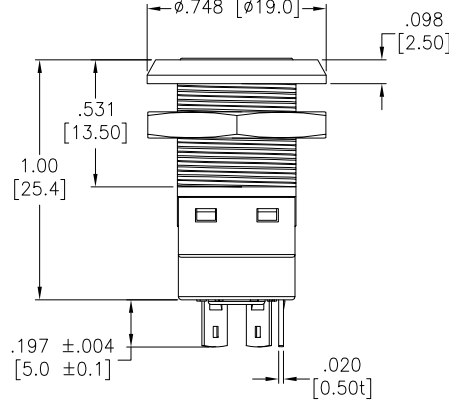

KEY CAN BE REMOVED
 IN EITHER POSITION

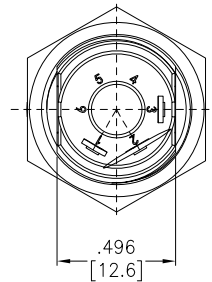
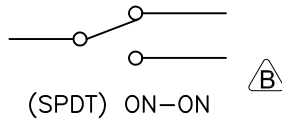

ADAM P/N	SPEC.
SW-R-K9-A	Key pulled on both positions. Note: this would be our standard
SW-R-K9-B	Key pulled on 1 position

SPECIFICATIONS:

Material:
 Body: Steel, Polished Chrome
 Electrical:
 Rating: 4A @ 125V AC
 2A @ 250V AC

Contact resistance: 100 mohms max (Initial)
 Insulation resistance: 500 Mohms min @ 500V AC
 Dielectric withstanding voltage: 500V AC for 1 Min.

Mechanical:
 Operating Life: 5,000 cycles min
 Temperature Rating:
 Operating temperature: -25°C to +85°C

Environmental:
 Lead free, RoHS compliant



UNLESS OTHERWISE SPECIFIED ALL DIMENSIONS
 ARE INCHES [MM]. TOLERANCES: EXCEPT AS NOTED

INCHES	HOLES
.x ± .10	∅x ± .10
.xx ± .020	∅xx ± .015
.xxx ± .015	∅xxx ± .010



909 Rahway Avenue,
 Union, NJ 07083
 Phone: 908-687-5000
 Fax: 908-687-5710

DRAWN	SS	9/24/20
CHECKED	SS	9/24/20
APPROVED		

TITLE SWITCH, KEYLOCK, 16MM, SPDT, ON-ON,
 PANEL MOUNT, SOLDER TERMINAL

THIS DRAWING CONTAINS INFORMATION THAT IS PROPRIETARY
 AND SHOULD NOT BE USED WITHOUT PRIOR WRITTEN
 PERMISSION FROM ADAM TECH

SIZE X	PART NO. SW-R-K9-X	REV. B
REF: S00206C	SCALE: NTS	SHEET 1 OF 1