

Low-power dual voltage comparator

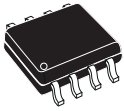

SO8



MiniSO8

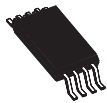

TSSOP8

Features

- Wide single supply voltage range or dual supplies +2 V to +36 V or ± 1 V to ± 18 V
- Very low supply current 0.5 mA typ., essentially independent of supply voltage
- Low input bias current: 20 nA typ.
- Low input offset current: ± 5 nA typ.
- Input common-mode voltage range includes negative rail
- Low output saturation voltage: 250 mV typ. ($I_{out} = 4$ mA)
- TTL, DTL, ECL, MOS, CMOS compatible outputs
- Automotive qualification

Applications

- Level shifters
- Sampling circuits
- Peak & zero crossing detectors
- Threshold detectors
- Automotive

Maturity status link

[LM2903B](#)

Description

The LM2903B consists of two independent low-power voltage comparators designed specifically to operate from a single supply over a wide range of voltages. It is fully specified at 5 V and 36 V supply voltage operation, however operation from dual power supplies is also possible.

The B-grade version of the LM2903 comparators offers an increased maximum operating voltage of 40 V and improved electrical characteristics.

1 Diagram and pin configuration

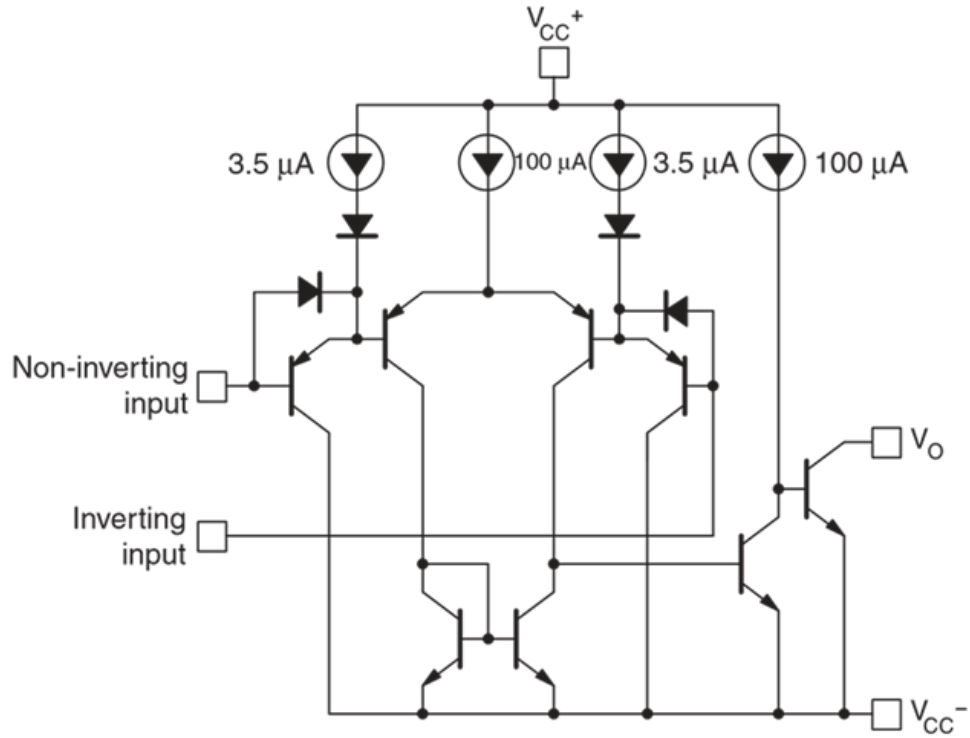
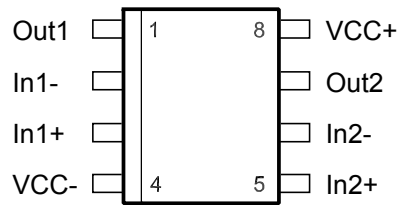
Figure 1. Diagram

Figure 2. Pin connections (top view)

SO8 / MiniSO8 / TSSOP8

2 Maximum ratings

Table 1. Absolute maximum ratings

Symbol	Parameter	Value	Unit
V_{cc}	Supply voltage ⁽¹⁾	±20 or 40	V
V_{id}	Differential input voltage ⁽²⁾	±40	
V_{in}	Input voltage	-0.3 to 40	
I_{in}	Input current ⁽³⁾	10	mA
	Output short-circuit current ⁽⁴⁾	30	mA
	Output short-circuit duration ⁽⁴⁾	Infinite	s
T_{stg}	Storage temperature range	-65 to 150	°C
T_j	Maximum junction temperature	150	
R_{thja}	Thermal resistance junction to ambient ⁽⁵⁾		°C/W
	SO-8	125	
	MiniSO-8	190	
R_{thjc}	Thermal resistance junction to case ⁽⁵⁾		
	SO-8	40	
	MiniSO-8	39	
TSSOP	37		
ESD	HBM: human body model ⁽⁶⁾	800	V
	MM: machine model ⁽⁷⁾	200	
	CDM: charged device model ⁽⁸⁾		
	SO-8	1500	
	MiniSO-8	1300	
TSSOP	1500		

1. All voltage values, except differential voltage, are with respect to network ground terminal.
2. Differential voltages are the non-inverting input terminal with respect to the inverting input terminal.
3. Input current must be limited by a resistor in series with the inputs to keep V_{in} in the range of the specified AMR.
4. Short-circuits from the output to V_{cc+} can cause excessive heating and eventual destruction. The maximum output current is approximately 30 mA.
5. Short-circuits can cause excessive heating and destructive dissipation. Values are typical.
6. Human body model: a 100 pF capacitor is charged to the specified voltage, then discharged through a 1.5 kΩ resistor between two pins of the device. This is done for all couples of connected pin combinations while the other pins are floating.
7. Machine model: a 200 pF capacitor is charged to the specified voltage, then discharged directly between two pins of the device with no external series resistor (internal resistor < 5 Ω). This is done for all couples of connected pin combinations while the other pins are floating.
8. Charged device model: all pins and the package are charged together to the specified voltage and then discharged directly to the ground through only one pin. This is done for all pins.

Table 2. Operating conditions

Symbol	Parameter	Value	Unit
V_{CC}	Supply voltage	2 to 36	V
V_{ICM}	Common-mode input voltage range $T_{amb} = 25\text{ }^{\circ}\text{C}$ Common-mode input voltage range $T_{min} \leq T_{amb} \leq T_{max}$	V_{CC-} to $V_{CC+} - 1.5$ V_{CC-} to $V_{CC+} - 2$	
T	Operating free-air temperature range	-40 to 125	$^{\circ}\text{C}$

3 Electrical characteristics

$V_{CC+} = 5\text{ V}$ and 36 V , $V_{CC-} = 0\text{ V}$, $V_O = 1.4\text{ V}$, R_I connected to ground, $T = 25\text{ }^\circ\text{C}$ (unless otherwise specified).

Table 3. Electrical characteristics

Symbol	Parameter	Min.	Typ.	Max.	Unit
V_{io}	Input offset voltage ⁽¹⁾ $T_{min} < T < T_{max}$			4 5	mV
I_{ib}	Input bias current ⁽²⁾ $T_{min} < T < T_{max}$		20	150 200	nA
I_{io}	Input offset current $T_{min} < T < T_{max}$		5	30 40	nA
A_{vd}	$V_{CC} = 15\text{ V}$, $R_L = 15\text{ k}\Omega$, $V_O = 1\text{ to }11\text{ V}$ ⁽³⁾		200		V / mV
I_{CC}	Supply current, all comparators, no load $V_{CC} = 5\text{ V}$ $T_{min} < T < T_{max}$ $V_{CC} = 36\text{ V}$ $T_{min} < T < T_{max}$		0.4 0.6	1 1 2.5 2.5	mA
V_{id}	Differential input voltage			V_{CC}	V
V_{ol}	Low-level output voltage $V_{CC} = 5\text{ V}$, $V_{id} = -1\text{ V}$, $I_{sink} = 4\text{ mA}$ $T_{min} < T < T_{max}$ $V_{CC} = 36\text{ V}$, $V_{id} = -1\text{ V}$, $I_{sink} = 4\text{ mA}$ $T_{min} < T < T_{max}$		250 250	350 600 350 600	mV
I_{oh}	High-level output current $V_{CC} = V_O = 36\text{ V}$, $V_{id} = 1\text{ V}$ $T_{min} < T < T_{max}$		0.1	1	nA μA
I_{sink}	Output sink current $V_{id} = -1\text{ V}$, $V_O = 1.5\text{ V}$ $V_{CC} = 5\text{ V}$ $T_{min} < T < T_{max}$ $V_{CC} = 36\text{ V}$ $T_{min} < T < T_{max}$	8 7 11 10	17 10 22 13		mA
t_{res}	Small signal response time $R_L = 5.1\text{ k}\Omega$ to V_{CC} ⁽⁴⁾ $V_{CC} = 5\text{ V}$ $V_{CC} = 36\text{ V}$		1.0 0.9		μs
t_{rel}	Large signal response time ⁽⁵⁾ TTL input ($V_{ref} = +1.4\text{ V}$, $R_L = 5.1\text{ k}\Omega$ to V_{CC}) Output signal at 50% of final value Output signal at 95% of final value			500 1	ns μs

1. At output switch point, $V_O \approx 1.4\text{ V}$, $R_S = 0\text{ }\Omega$ with V_{CC} from 5 V to 36 V , and over the full input common-mode range (0 V to $V_{CC} - 1.5\text{ V}$).

2. The direction of the input current is out of the IC due to the PNP input stage. This current is essentially constant, independent of the state of the output, so no loading charge exists on the reference of input lines.

3. *Positive excursions of input voltage may exceed the power supply level. As long as the other voltage remains within the common-mode range, the comparator provides a proper output state. The low input voltage state must not be less than -0.3 V (or 0.3 V below the negative power supply, if used).*
4. *The response time specified is for a 100 mV input step with 5 mV overdrive.*
5. *Maximum values are guaranteed by design and evaluation.*

4 Typical performance characteristics

Figure 3. Supply current vs. supply voltage

Figure 4. Input offset voltage vs. supply voltage

Figure 5. Input offset voltage vs. common-mode voltage at $V_{CC} = 36\text{ V}$

Figure 6. Input bias current vs. supply voltage at $V_{cm} = V_{CC}/2$

Figure 7. Input bias current vs. common-mode voltage at $V_{CC} = 36\text{ V}$

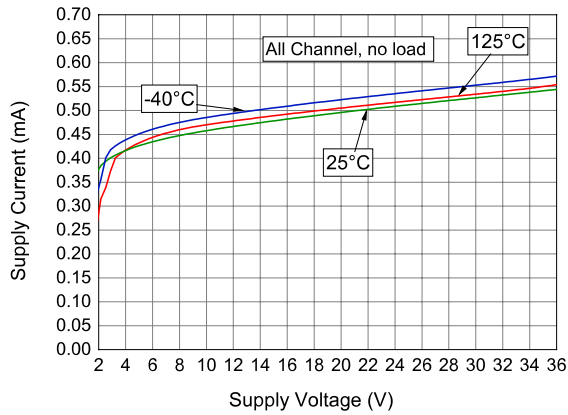
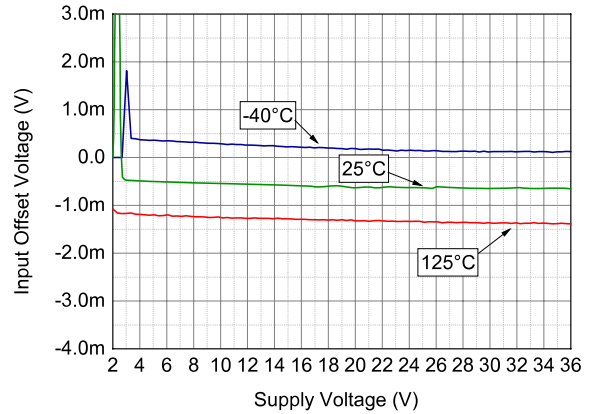
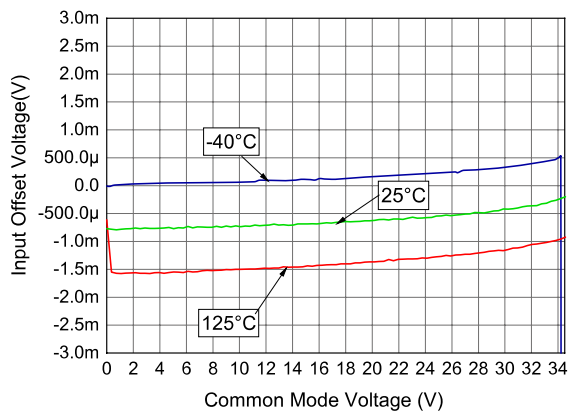
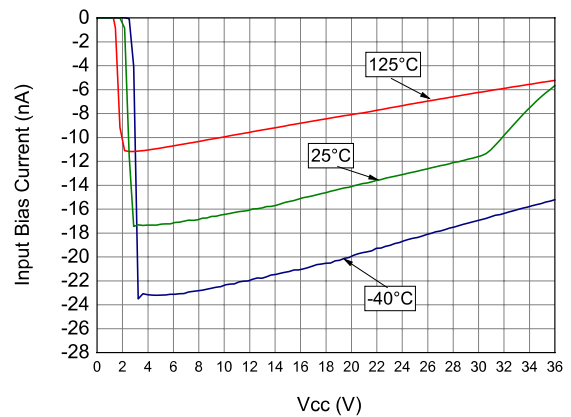
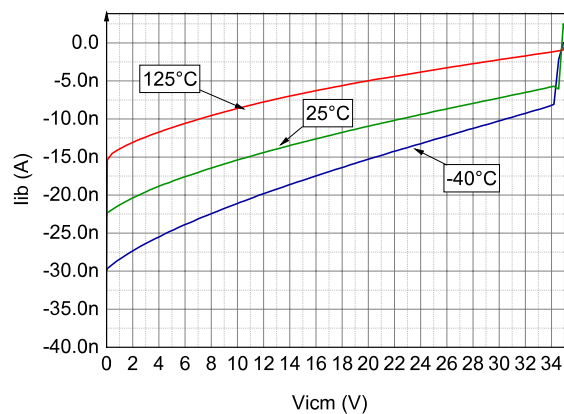
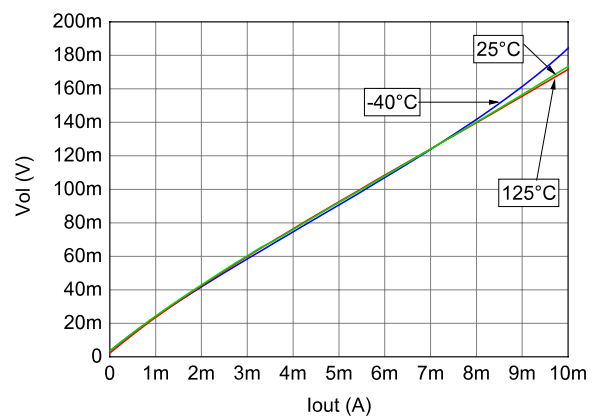
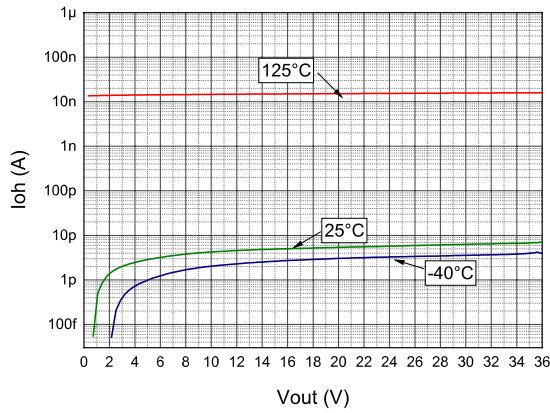
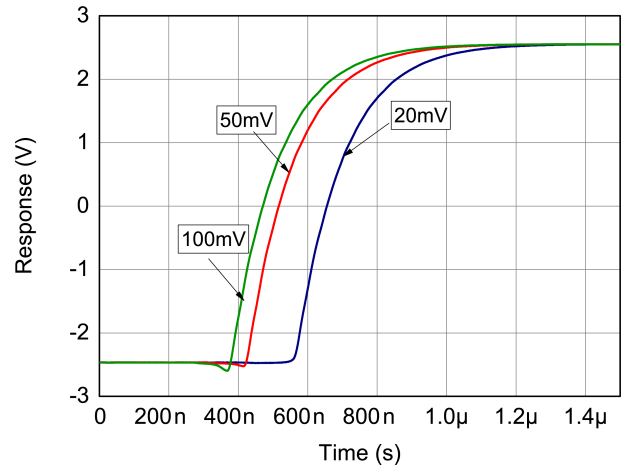
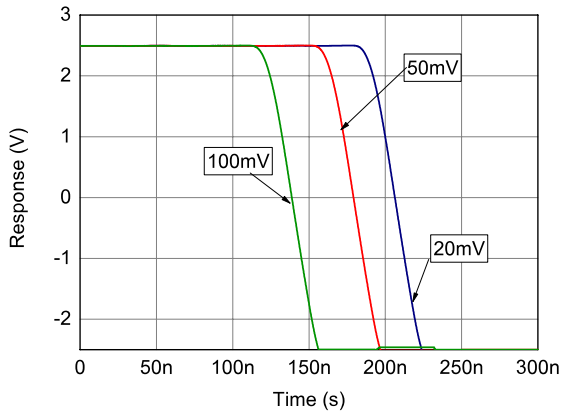
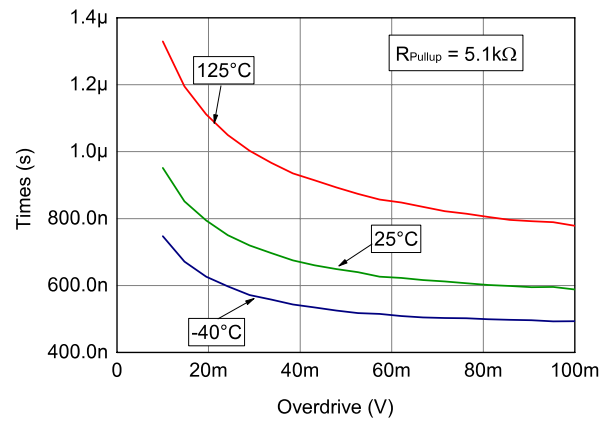
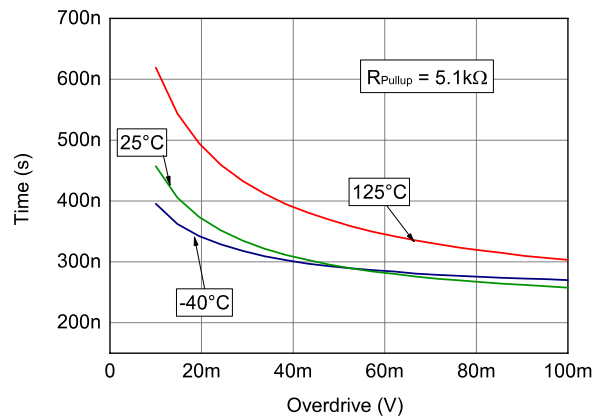
Figure 8. Output saturation voltage vs. output current

Figure 9. Output saturation current vs. output voltage at $V_{CC} = 36\text{ V}$

Figure 10. Positive step response

Figure 11. Negative step response

Figure 12. Propagation delay vs. overdrive for positive steps at $V_{CC} = 36\text{ V}$

Figure 13. Propagation delay vs. overdrive for negative steps at $V_{CC} = 36\text{ V}$

5 Package information

In order to meet environmental requirements, ST offers these devices in different grades of **ECOPACK** packages, depending on their level of environmental compliance. ECOPACK specifications, grade definitions and product status are available at: www.st.com. ECOPACK is an ST trademark.

5.1 SO8 package information

Figure 14. SO8 package outline

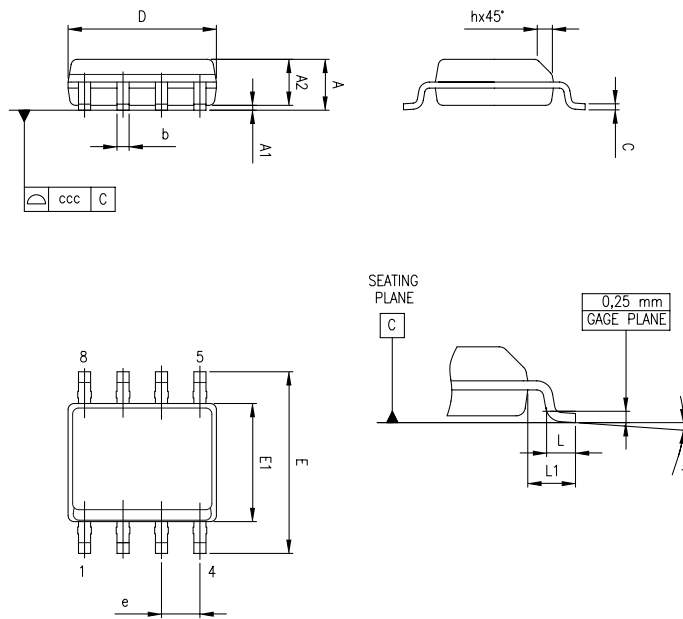
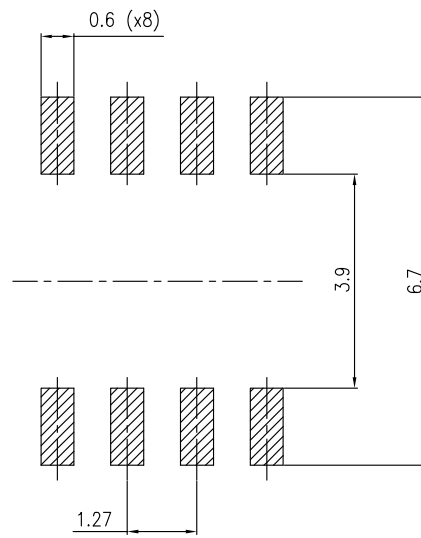

Table 4. SO8 package mechanical data

Ref.	Dimensions					
	Millimeters			Inches		
	Min.	Typ.	Max.	Min.	Typ.	Max.
A			1.75			0.069
A1	0.10		0.25	0.04		0.010
A2	1.25			0.049		
b	0.28	0.40	0.48	0.011	0.016	0.019
c	0.17		0.23	0.007		0.010
D	4.80	4.90	5.00	0.189	0.193	0.197
E	5.80	6.00	6.20	0.228	0.236	0.244
E1	3.80	3.90	4.00	0.150	0.154	0.157
e		1.27			0.050	
h	0.25		0.50	0.010		0.020
L	0.40	0.635	1.27	0.016		0.050
L1		1.04			0.040	
k	1°		8°	1°		8°
ccc			0.10			0.004

Figure 15. SO8 recommended footprint



5.2 MiniSO8 package information

Figure 16. MiniSO8 package outline

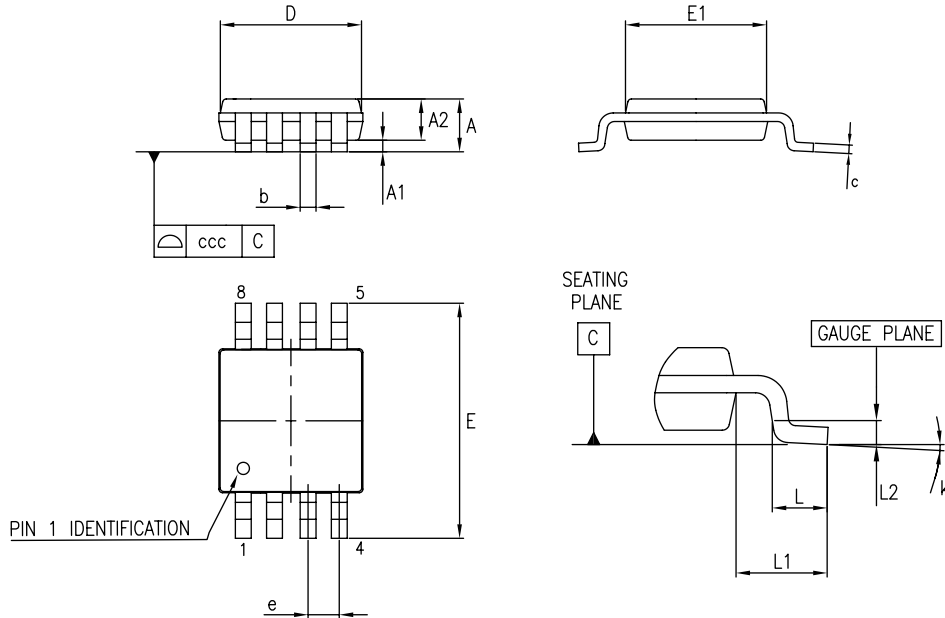
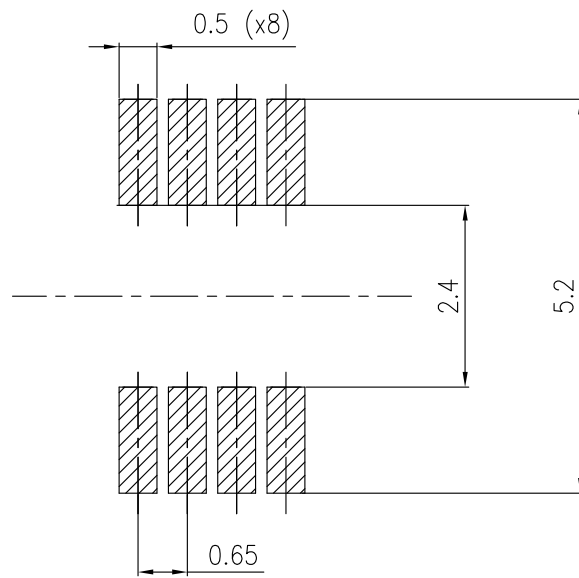

Table 5. MiniSO8 mechanical data

Dim.	Millimeters			Inches		
	Min.	Typ.	Max.	Min.	Typ.	Max.
A			1.1			0.043
A1	0		0.15	0		0.006
A2	0.75	0.85	0.95	0.03	0.033	0.037
b	0.22		0.4	0.009		0.016
c	0.08		0.23	0.003		0.009
D	2.8	3	3.2	0.11	0.118	0.126
E	4.65	4.9	5.15	0.183	0.193	0.203
E1	2.8	3	3.1	0.11	0.118	0.122
e		0.65			0.026	
L	0.4	0.6	0.8	0.016	0.024	0.031
L1		0.95			0.037	
L2		0.25			0.01	
k	0°		8°	0°		8°
ccc			0.1			0.004

Figure 17. MiniSO8 recommended footprint



5.3 TSSOP8 package information

Figure 18. TSSOP8 package outline

SIDE VIEW

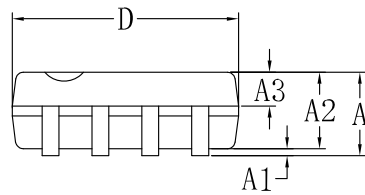
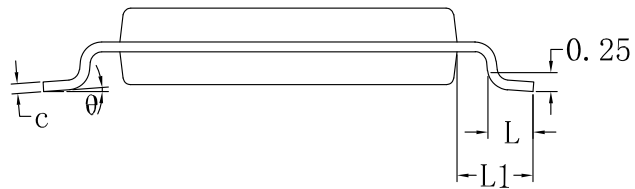

TOP VIEW

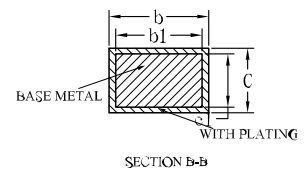
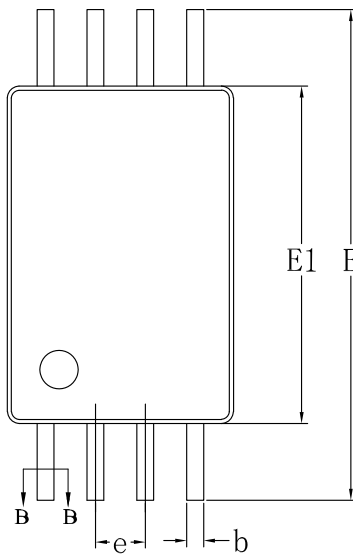
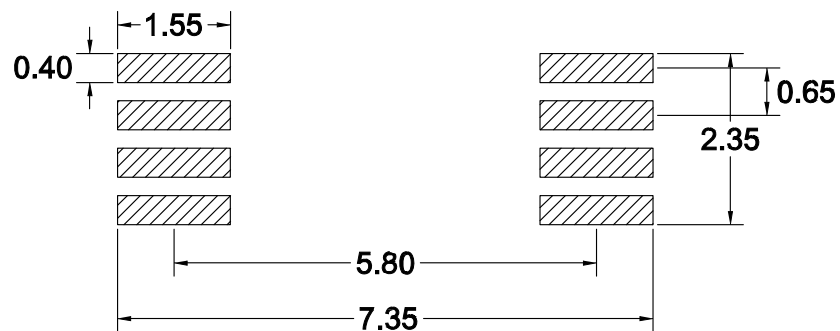

Table 6. TSSOP8 mechanical data

Dim.	mm		
	Min.	Typ.	Max.
A	-	-	1.20
A1	0.05	-	0.15
A2	0.90	1.00	1.05
A3	0.39	0.44	0.49
b	0.20	-	0.28
b1	0.19	0.22	0.25
D2	3.55	3.65	3.75
c	0.13	-	0.17
c1	0.12	0.13	0.14
D	2.90	3.00	3.10
E1	4.30	4.40	4.50
E	6.20	6.40	6.60
e	0.65 BSC		
L	0.45	-	0.75
L1	1.00 REF		
θ	0°	-	8°

Figure 19. TSSOP8 recommended footprint



6 Ordering information

Table 7. Order code

Order code	Temperature range	Package	Packaging	Marking
LM2903BYDT ⁽¹⁾	-40 to +125 °C	SO-8	Tape & reel	2903BY
LM2903BYST ⁽¹⁾		MiniSO-8		K432
LM2903BYPT ⁽¹⁾		TSSOP8		2903B

1. Qualified and characterized according to AEC Q100 and Q003 or equivalent, advanced screening according to AEC Q001 & Q 002 or equivalent.

Revision history

Table 8. Document revision history

Date	Revision	Changes
27-Sep-2022	1	Initial release.
13-Dec-2022	2	<p>Updated figure and description on the cover page, Table 1, Figure 10, Figure 11, Figure 12 and Figure 13.</p> <p>Added new TSSOP8 package on the cover, new Section 5.3 TSSOP8 package information, LM2903BYPT order code in Table 7. Order code, Figure 15. SO8 recommended footprint and Figure 17. MiniSO8 recommended footprint.</p>

Contents

1	Diagram and pin configuration	2
2	Maximum ratings	3
3	Electrical characteristics	5
4	Typical performance characteristics	7
5	Package information	9
5.1	SO8 package information	9
5.2	MiniSO8 package information	11
5.3	TSSOP8 package information	13
6	Ordering information	15
	Revision history	16

List of tables

Table 1.	Absolute maximum ratings	3
Table 2.	Operating conditions	4
Table 3.	Electrical characteristics	5
Table 4.	SO8 package mechanical data	9
Table 5.	MiniSO8 mechanical data	11
Table 6.	TSSOP8 mechanical data	14
Table 7.	Order code	15
Table 8.	Document revision history	16

List of figures

Figure 1.	Diagram	2
Figure 2.	Pin connections (top view)	2
Figure 3.	Supply current vs. supply voltage	7
Figure 4.	Input offset voltage vs. supply voltage	7
Figure 5.	Input offset voltage vs. common-mode voltage at $V_{cc} = 36\text{ V}$	7
Figure 6.	Input bias current vs. supply voltage at $V_{cm} = V_{cc}/2$	7
Figure 7.	Input bias current vs. common-mode voltage at $V_{cc} = 36\text{ V}$	7
Figure 8.	Output saturation voltage vs. output current	7
Figure 9.	Output saturation current vs. output voltage at $V_{cc} = 36\text{ V}$	8
Figure 10.	Positive step response	8
Figure 11.	Negative step response	8
Figure 12.	Propagation delay vs. overdrive for positive steps at $V_{cc} = 36\text{ V}$	8
Figure 13.	Propagation delay vs. overdrive for negative steps at $V_{cc} = 36\text{ V}$	8
Figure 14.	SO8 package outline	9
Figure 15.	SO8 recommended footprint	10
Figure 16.	MiniSO8 package outline	11
Figure 17.	MiniSO8 recommended footprint	12
Figure 18.	TSSOP8 package outline	13
Figure 19.	TSSOP8 recommended footprint	14

IMPORTANT NOTICE – READ CAREFULLY

STMicroelectronics NV and its subsidiaries (“ST”) reserve the right to make changes, corrections, enhancements, modifications, and improvements to ST products and/or to this document at any time without notice. Purchasers should obtain the latest relevant information on ST products before placing orders. ST products are sold pursuant to ST’s terms and conditions of sale in place at the time of order acknowledgment.

Purchasers are solely responsible for the choice, selection, and use of ST products and ST assumes no liability for application assistance or the design of purchasers’ products.

No license, express or implied, to any intellectual property right is granted by ST herein.

Resale of ST products with provisions different from the information set forth herein shall void any warranty granted by ST for such product.

ST and the ST logo are trademarks of ST. For additional information about ST trademarks, refer to www.st.com/trademarks. All other product or service names are the property of their respective owners.

Information in this document supersedes and replaces information previously supplied in any prior versions of this document.

© 2022 STMicroelectronics – All rights reserved