

P-Channel Enhancement Mode Power MOSFET

Description

The G75P04F uses advanced trench technology to provide excellent $R_{DS(ON)}$, low gate charge. It can be used in a wide variety of applications.

General Features

- V_{DS} -40V
- I_D (at $V_{GS} = -10V$) -54A
- $R_{DS(ON)}$ (at $V_{GS} = -10V$) < 7m Ω
- $R_{DS(ON)}$ (at $V_{GS} = -4.5V$) < 9m Ω
- 100% Avalanche Tested
- RoHS Compliant

Application

- Power switch
- DC/DC converters

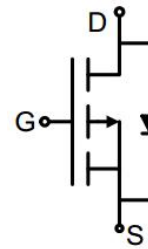

Schematic diagram

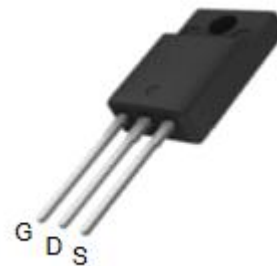

TO-220F

Ordering Information

Device	Package	Marking	Packaging
G75P04F	TO-220F	G75P04	50pcs/Tube

Absolute Maximum Ratings $T_C = 25^\circ\text{C}$, unless otherwise noted

Parameter	Symbol	Value	Unit
Drain-Source Voltage	V_{DS}	-40	V
Continuous Drain Current	I_D	-54	A
Pulsed Drain Current (note1)	I_{DM}	-216	A
Gate-Source Voltage	V_{GS}	± 20	V
Power Dissipation	P_D	35.7	W
Single pulse avalanche energy (note2)	E_{AS}	306	mJ
Operating Junction and Storage Temperature Range	T_J, T_{stg}	-55 To 150	$^\circ\text{C}$

Thermal Resistance

Parameter	Symbol	Value	Unit
Thermal Resistance, Junction-to-Ambient	R_{thJA}	40	$^\circ\text{C/W}$
Maximum Junction-to-Case	R_{thJC}	3.5	$^\circ\text{C/W}$

Specifications $T_J = 25^\circ\text{C}$, unless otherwise noted						
Parameter	Symbol	Test Conditions	Value			Unit
			Min.	Typ.	Max.	
Static Parameters						
Drain-Source Breakdown Voltage	$V_{(BR)DSS}$	$V_{GS} = 0V, I_D = -250\mu A$	-40	--	--	V
Zero Gate Voltage Drain Current	I_{DSS}	$V_{DS} = -40V, V_{GS} = 0V$	--	--	-1	μA
Gate-Source Leakage	I_{GSS}	$V_{GS} = \pm 20V$	--	--	± 100	nA
Gate-Source Threshold Voltage	$V_{GS(th)}$	$V_{DS} = V_{GS}, I_D = -250\mu A$	-1.0	-1.45	-2.5	V
Drain-Source On-Resistance	$R_{DS(on)}$	$V_{GS} = -10V, I_D = -10A$	--	5.1	7.0	m Ω
		$V_{GS} = -4.5V, I_D = -10A$	--	6.6	9.0	
Forward Transconductance	g_{FS}	$V_{DS} = -5V, I_D = -10A$	--	32	--	S
Dynamic Parameters						
Input Capacitance	C_{iss}	$V_{GS} = 0V,$ $V_{DS} = -20V,$ $f = 1.0\text{MHz}$	--	6768	--	pF
Output Capacitance	C_{oss}		--	693	--	
Reverse Transfer Capacitance	C_{rss}		--	666	--	
Total Gate Charge	Q_g	$V_{DD} = -20V,$ $I_D = -10A,$ $V_{GS} = -10V$	--	106	--	nC
Gate-Source Charge	Q_{gs}		--	22	--	
Gate-Drain Charge	Q_{gd}		--	27	--	
Turn-on Delay Time	$t_{d(on)}$	$V_{DD} = -20V,$ $I_D = -10A,$ $R_G = 1\Omega$	--	15	--	ns
Turn-on Rise Time	t_r		--	12	--	
Turn-off Delay Time	$t_{d(off)}$		--	70	--	
Turn-off Fall Time	t_f		--	18	--	
Drain-Source Body Diode Characteristics						
Continuous Body Diode Current	I_S	$T_C = 25^\circ\text{C}$	--	--	-54	A
Body Diode Voltage	V_{SD}	$T_J = 25^\circ\text{C}, I_{SD} = -10A, V_{GS} = 0V$	--	--	-1.2	V
Reverse Recovery Charge	Q_{rr}	$I_F = -10A, V_{GS} = 0V$ $di/dt = -100A/\mu s$	--	50	--	nC
Reverse Recovery Time	T_{rr}		--	53	--	ns

Notes

1. Repetitive Rating: Pulse width limited by maximum junction temperature
2. EAS condition : $T_J = 25^\circ\text{C}, V_{DD} = -40V, V_{GS} = -10V, L = 0.5\text{mH}, R_G = 25\Omega$
3. Identical low side and high side switch with identical R_G

Gate Charge Test Circuit



Switch Time Test Circuit



EAS Test Circuit



Typical Characteristics $T_J = 25^\circ\text{C}$, unless otherwise noted

Figure 1. Output Characteristics

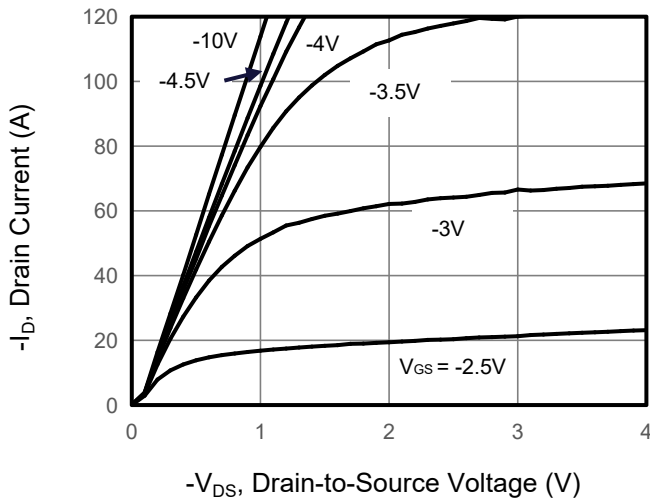

Figure 2. Transfer Characteristics

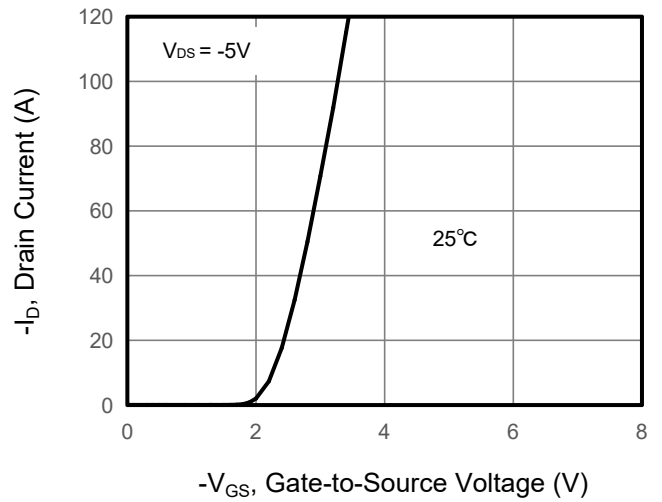

Figure 3. Drain Source On Resistance

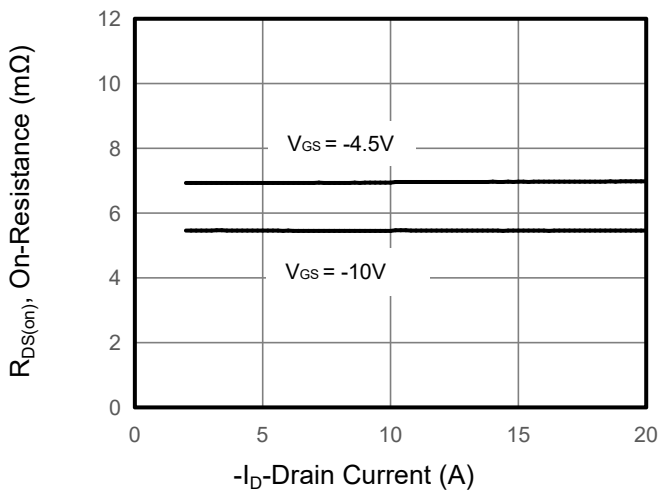

Figure 4. Gate Charge

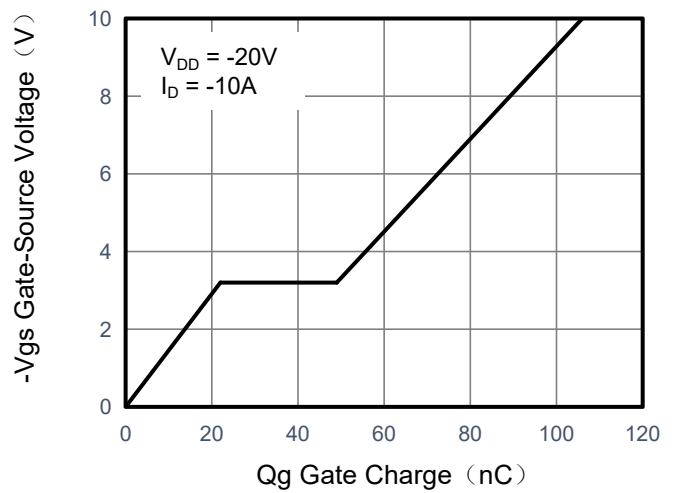

Figure 5. Capacitance

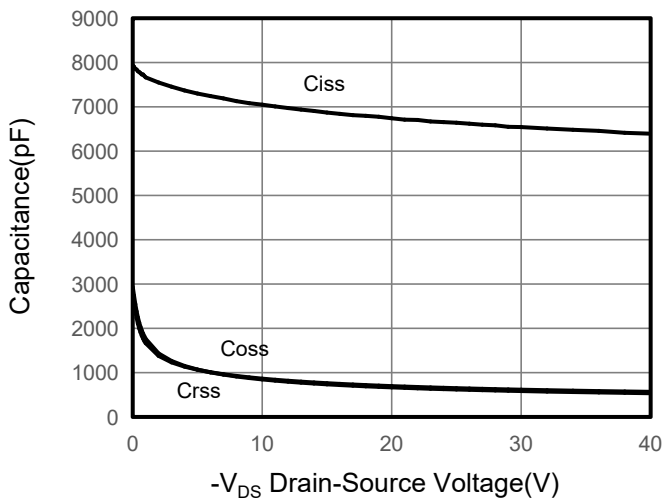
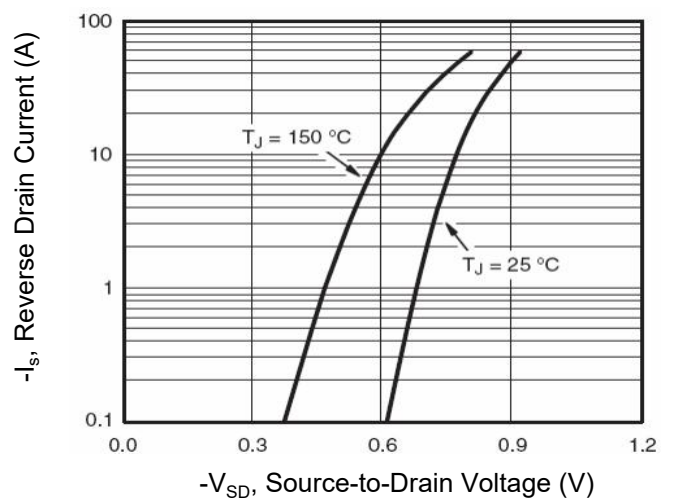

Figure 6. Source-Drain Diode Forward



Typical Characteristics $T_J = 25^\circ\text{C}$, unless otherwise noted

Figure 7. Drain-Source On-Resistance

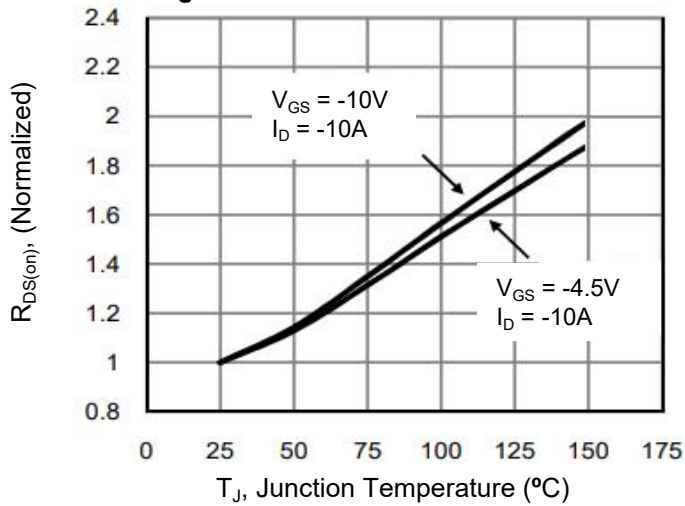

Figure 10. Safe Operation Area

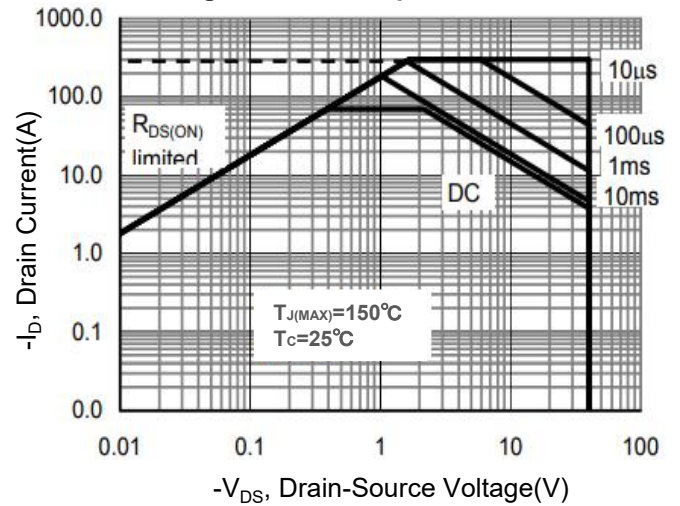
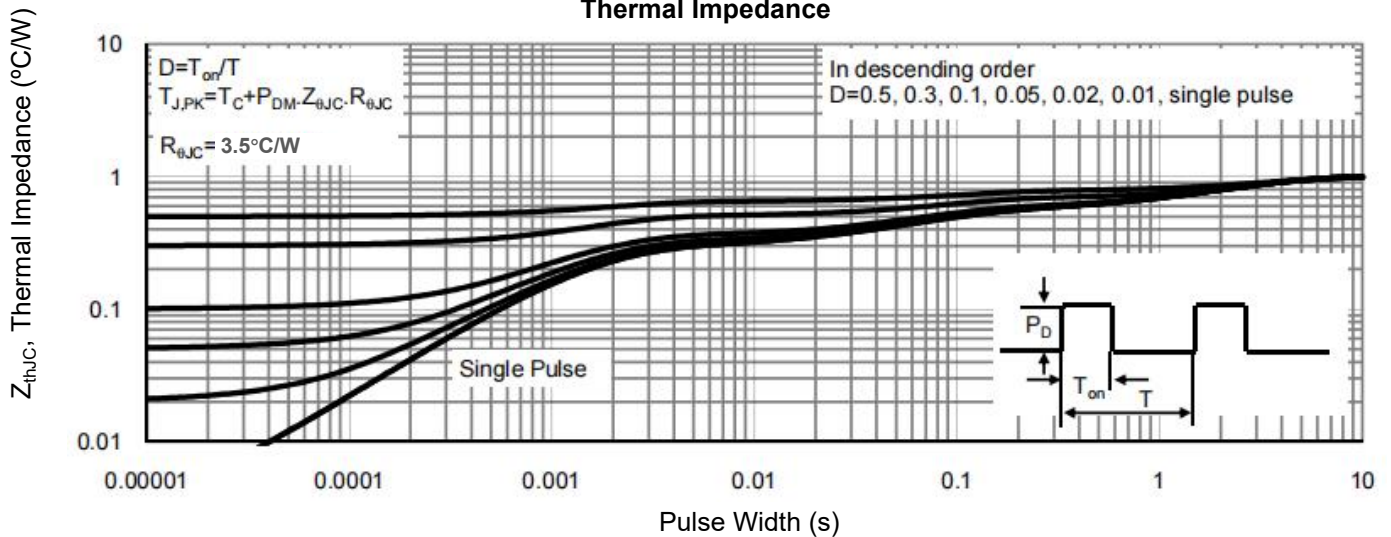
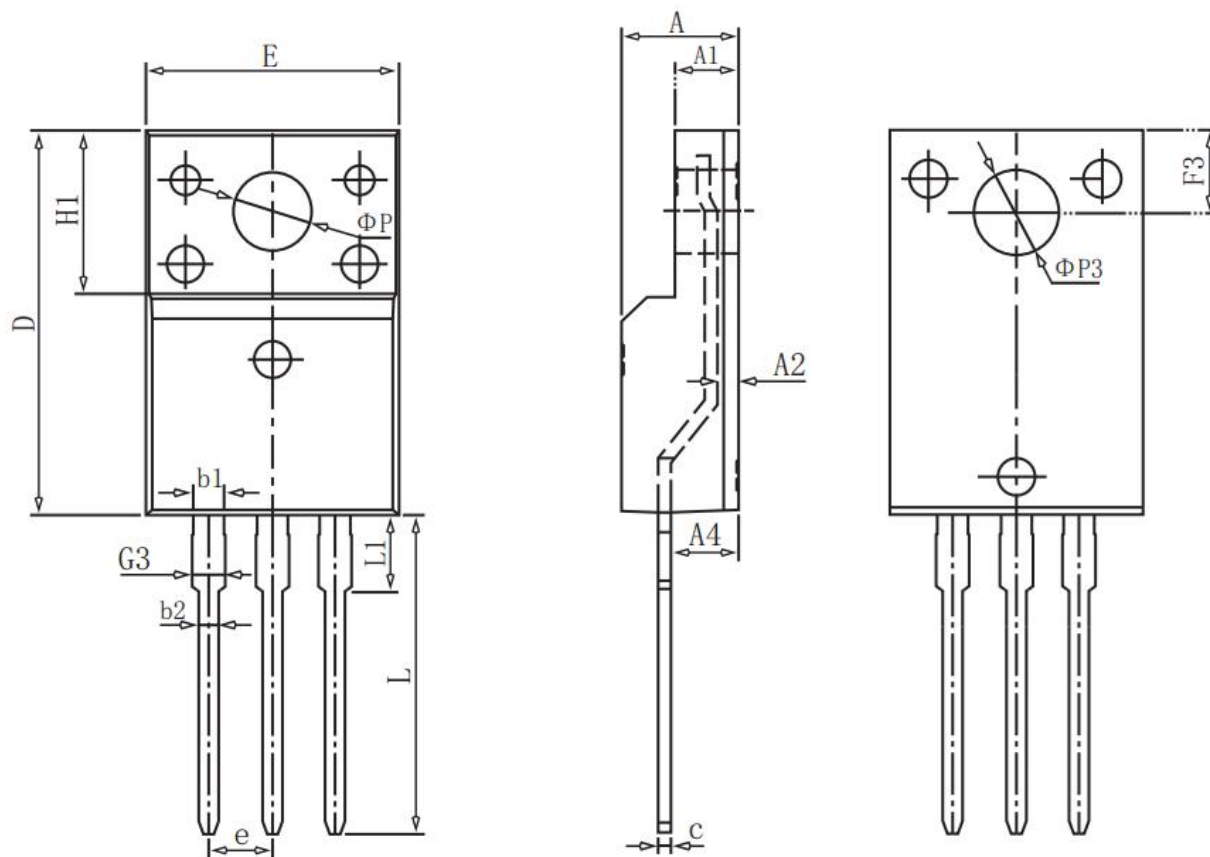

Figure 9. Normalized Maximum Transient Thermal Impedance



TO-220F Package Information



COMMON DIMENSIONS

SYMBOL	mm		
	MIN	NOM	MAX
E	10.00	10.20	10.40
A	4.50	4.70	4.90
A1	2.34	2.54	2.74
A2	0.65	0.85	1.30
A4	2.55	2.75	2.95
c	0.40	0.50	0.65
D	15.57	15.87	16.17
H1	6.70REF		
e	2.54BSC		
ΦP	3.183REF		
L	12.68	12.98	13.28
L_1	3.25	3.45	3.65
ΦP_3	3.45REF		
F3	3.10	3.30	3.50
G3	1.10	1.30	1.50
b_1	1.05	1.20	1.35
b_2	0.70	0.80	0.92