

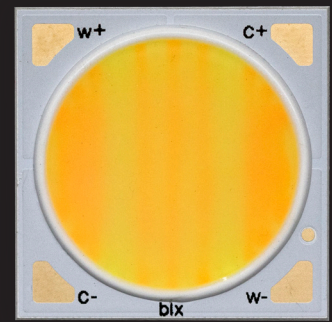
# Bridgelux® Vesta® Series Tunable White Gen 2 18mm Array

Product Data Sheet DS353



# Introduction

Vesta® Series



Vesta® Series Tunable White Array products deliver adaptable light in a solid state lighting package. Vesta Series products tap into the powerful mediums of light and color to influence experience, well-being, and human emotion. They allow designers to mimic daylight to increase productivity and well-being, retailers to influence shopper behavior and fixture manufacturers to simulate the familiar glow and dimming of incandescent lamps. This high flux density light source is designed to support a wide range of high quality directional luminaires and replacement lamps for commercial and residential applications.

Lighting system designs incorporating these LED arrays deliver comparable performance to 150 Watt incandescent-based luminaires, while increasing system level efficacy and prolonging service life. Typical luminaire and lamp types appropriate for this family include replacement lamps, down lights, wall packs and accent, spot and track lights.

## Features

- Tuning range from 2700K-5000K, 2700K-6500K and 1800K-4000K
- 3 SDCM binning for 2700K, 4000K, 5000K and 6500K color points
- Efficacy of up to 127 lm/W typical
- Flux packages of up to 3700lm typical
- Minimum 90 CRI
- Proprietary packaging technology to improve near field color uniformity

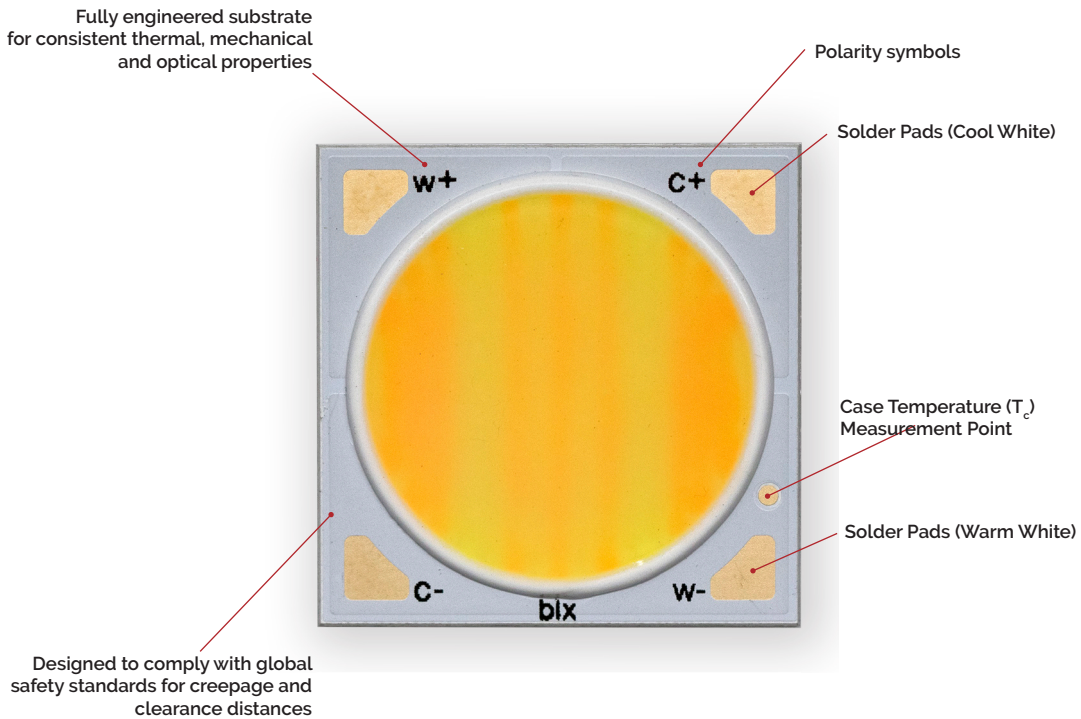
## Benefits

- Maximum design flexibility, the industry's largest selection of tuning ranges
- Delivers the required lumens for a wide variety of lighting applications
- Precise color mixing and consistency
- High quality, true color reproduction
- Suitable for most narrow beam optics of  $\geq 15$  degrees FWHM
- Greater energy savings, lower utility costs



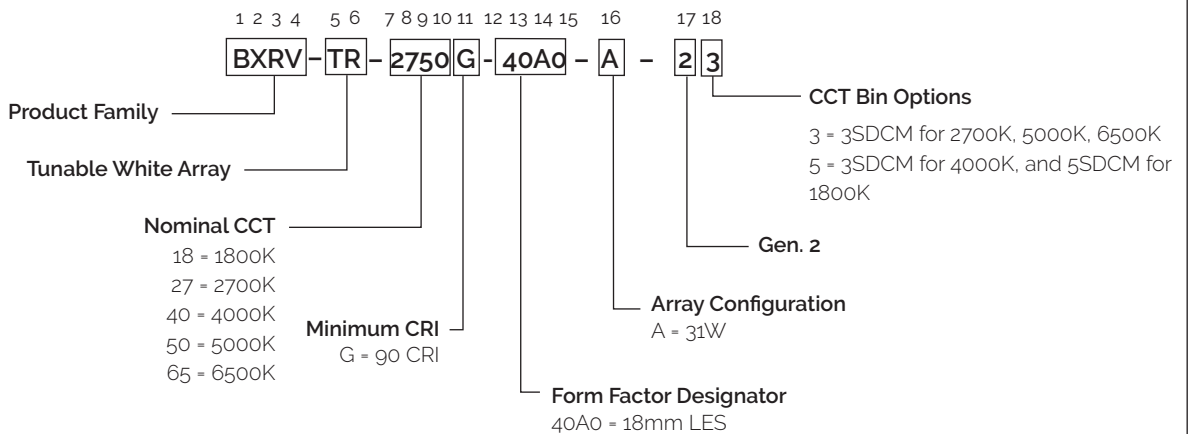
# Product Feature Map

Bridgelux arrays are fully engineered devices that provide consistent thermal and optical performance on an engineered mechanical platform. The arrays incorporate several features to simplify design integration and assembly. Please visit [www.bridgelux.com](http://www.bridgelux.com) for more information on the Vesta Series family of products.



## Product Nomenclature

The part number designation for Bridgelux Vesta Series arrays is explained as follows:



# Product Selection Guide

The following product configurations are available:

**Table 1:** Selection Guide, Measurement Data

Part Number	Nominal CCT <sup>1</sup> T <sub>c</sub> =85°C (K)	Typical CRI <sup>2</sup> T <sub>c</sub> =85°C	Nominal Drive Current per channel (mA)	Typical V <sub>f</sub> <sup>3</sup> T <sub>c</sub> =25°C (V)	Typical Power T <sub>c</sub> =25°C (W)	Typical Pulsed Flux <sup>3,4,5</sup> T <sub>c</sub> =25°C (lm)	Typical Efficacy <sup>5</sup> T <sub>c</sub> =25°C (lm/W)	Minimum Pulsed Flux <sup>8</sup> T <sub>c</sub> =25°C (lm)	Typical DC Flux <sup>7,8</sup> T <sub>c</sub> =85°C (lm)
BXRV-TR-2750G-40A0-A-23	2700	93	900	34.9	31.4	3548	113	3193	3122
	5000	92	900	35.3	31.7	3741	118	3367	3292
BXRV-TR-2765G-40A0-A-23	2700	93	900	34.9	31.4	3548	113	3193	3122
	6500	92	900	35.3	31.7	4026	127	3623	3543
BXRV-TR-1840G-40A0-A-23	1800	93	900	34.9	31.4	2650	84	2385	2332
	4000	92	900	35.3	31.8	3980	125	3582	3463

Notes for Table 1:

- Nominal CCT as defined by ANSI C78.377-2011.
- For CRI 92-93 products, the minimum CRI value is 90 and the minimum Rg value is 50. Bridgelux maintains a ±3 tolerance on all Rg values.
- Products tested under pulsed condition (10ms pulse width) at nominal test current where T<sub>j</sub> (junction temperature) = T<sub>c</sub> (case temperature) = 25°C.
- Typical performance values are provided as a reference only and are not a guarantee of performance.
- Bridgelux maintains a ±7% tolerance on flux measurements.
- Typical stabilized DC performance values are provided as reference only and are not a guarantee of performance.
- Typical performance is estimated based on operation under DC (direct current) with LED array mounted onto a heat sink with thermal interface material and the case temperature maintained at 85°C. Based on Bridgelux test setup, values may vary depending on the thermal design of the luminaire and/or the exposed environment to which the product is subjected.
- Minimum flux values at pulsed nominal test current are guaranteed by 100% test.

# Electrical Characteristics

**Table 2:** Electrical Characteristics

Part Number	CCT (K)	Nominal Drive Current (mA)	Forward Voltage Pulsed, $T_c = 25^\circ\text{C}$ <sup>1, 2, 3, 7</sup>			Typical Temperature Coefficient of Forward Voltage <sup>4</sup> $\Delta V_f / \Delta T_c$ (mV/ $^\circ\text{C}$ )	Typical Thermal Resistance Junction to Case <sup>5</sup> ( $^\circ\text{C}/\text{W}$ )	Driver Selection Voltages <sup>6</sup>	
			Minimum (V)	Typical (V)	Maximum (V)			$V_f$ Min. Hot $T_c = 105^\circ\text{C}$ (V)	$V_f$ Max. Cold $T_c = -40^\circ\text{C}$ (V)
BXRV-TR-xxxxG-40A0-A-23	1800, 2700	900	32.8	34.9	36.9	-11.5	0.35	31.9	37.7
	4000, 5000, 6500	900	33.2	35.3	37.5	-11.6		32.3	38.2

Notes for Table 2:

- Parts are tested in pulsed conditions.  $T_c = 25^\circ\text{C}$ . Pulse width is 10ms.
- Voltage minimum and maximum are provided for reference only and are not a guarantee of performance.
- Bridgelux maintains a tester tolerance of  $\pm 0.10\text{V}$  on forward voltage measurements.
- Typical temperature coefficient of forward voltage tolerance is  $\pm 0.1\text{mV}$  for nominal current.
- Thermal resistance value was calculated using total electrical input power; optical power was not subtracted from input power. The thermal interface material used during testing is not included in the thermal resistance value.
- $V_f$  min hot and max cold values are provided as reference only and are not guaranteed by test. These values are provided to aid in driver design and selection over the operating range of the product.
- This product has been designed and manufactured per IEC 62031:2018. This product has passed dielectric withstand voltage testing at 500 V. The working voltage designated for the insulation is 60V DC. The maximum allowable voltage across the array must be determined in the end product application.

# Absolute Maximum Ratings

**Table 3:** Maximum Ratings

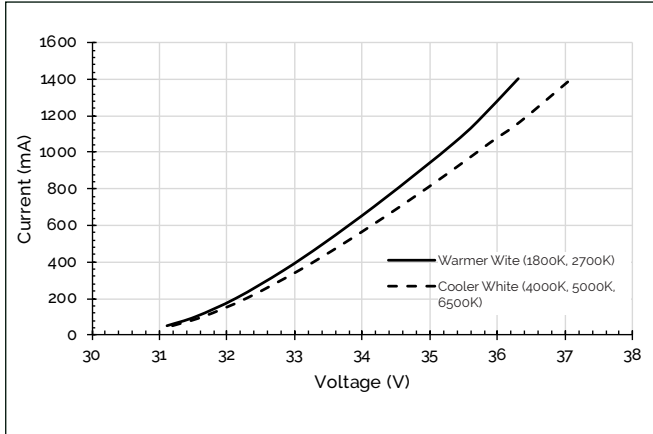
Parameter	Maximum Rating
LED Junction Temperature ( $T_j$ )	125°C
Storage Temperature	-40°C to +105°C
Operating Case Temperature <sup>1</sup> ( $T_c$ )	105°C
Soldering Temperature <sup>2</sup>	300°C or lower for a maximum of 6 seconds
Maximum Combined Drive Current <sup>3,4</sup>	1400mA
Maximum Peak Pulsed Drive Current <sup>5</sup>	1680mA for 2700K, 1440mA for 5000K/6500K
Maximum Total Power	49W

Notes for Table 3:

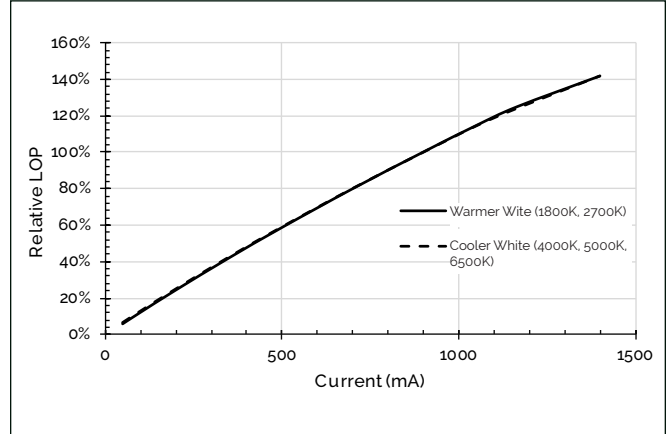
1. For IEC 62717 requirement, please contact Bridgelux Sales Support.
2. See Bridgelux Application Note AN101 "Handling and Assembly of LED Arrays" for more information.
3. The maximum drive current is defined as the maximum combined drive current in the 1800K/2700K and the 5000K/6500K channels. For example, if 1400mA is applied to the 1800K/2700K channel, then no current may be applied to the 4000K/5000K/6500K channel. If 400mA is applied to the 1800K/2700K channel, then a maximum of 1000mA may be applied to the 4000K/5000K/6500K channel.
4. Lumen maintenance and lifetime predictions are valid for drive current and case temperature conditions used for LM-80 testing as included in the applicable LM-80 test report. Contact your Bridgelux sales representatives for the LM-80 report.
5. Bridgelux recommends a maximum duty cycle of 10% and pulse width of 20ms when operating LED arrays at the maximum peak pulsed current specified. Maximum peak pulsed currents indicate values where the LED array can be driven without catastrophic failures.

# Performance Curves

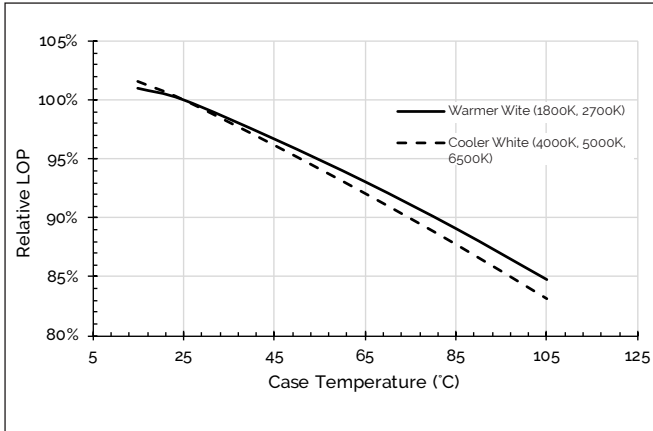
**Figure 1: Forward Voltage vs. Forward Current,  $T_c = 25^\circ\text{C}$**



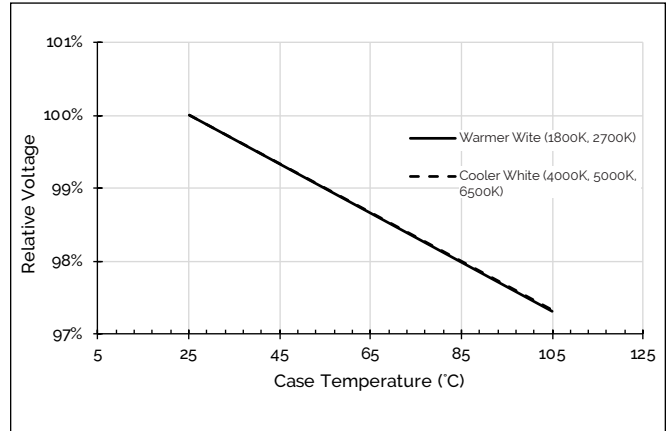
**Figure 2: Relative Flux vs. Drive Current,  $T_c = 25^\circ\text{C}$**



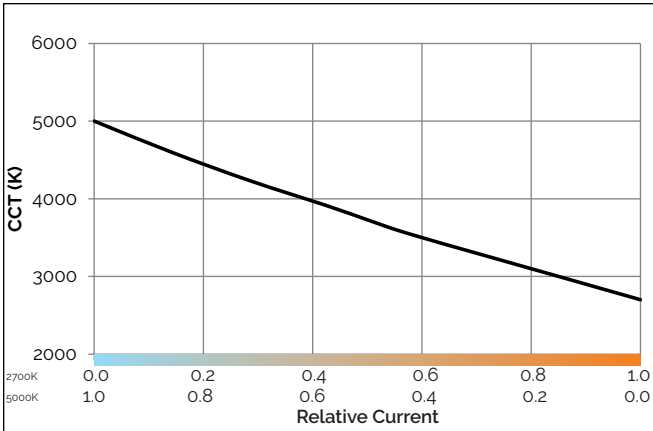
**Figure 3: Relative Flux vs. Case Temperature**



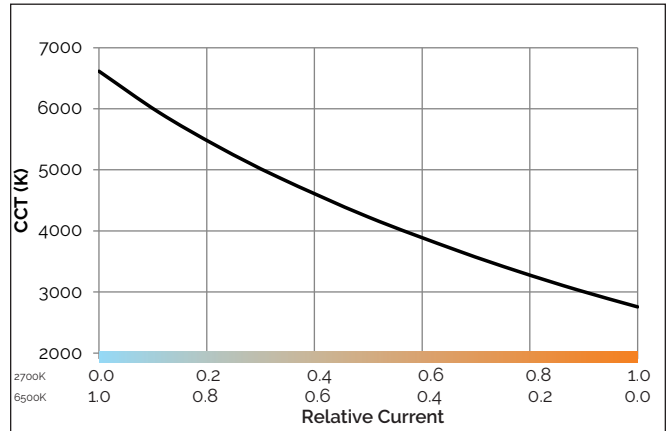
**Figure 4: Relative Voltage vs. Case Temperature**



**Figure 5: CCT vs. Relative Current,  $T_c = 85^\circ\text{C}$**

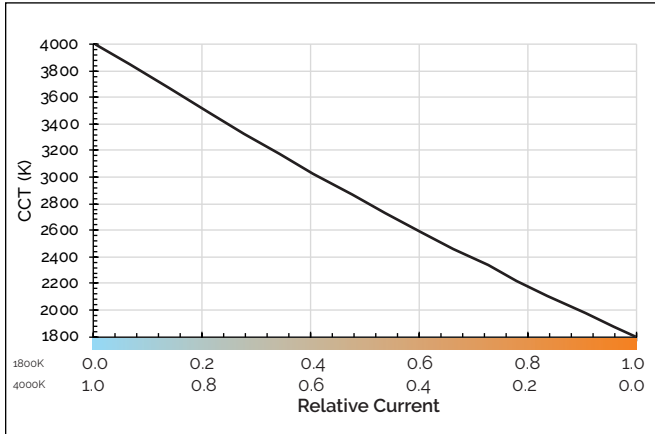


**Figure 6: CCT vs. Relative Current,  $T_c = 85^\circ\text{C}$**

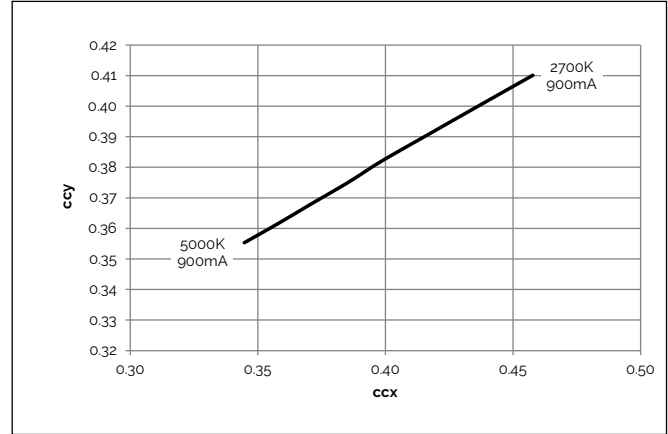


# Performance Curves

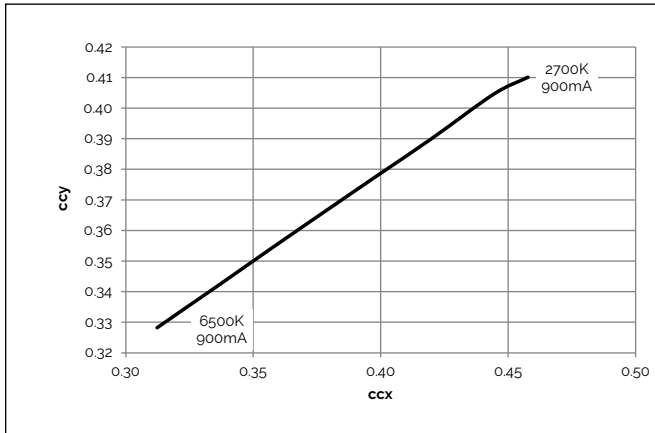
**Figure 7: CCT vs. Relative Current,  $T_c=85^\circ\text{C}$**



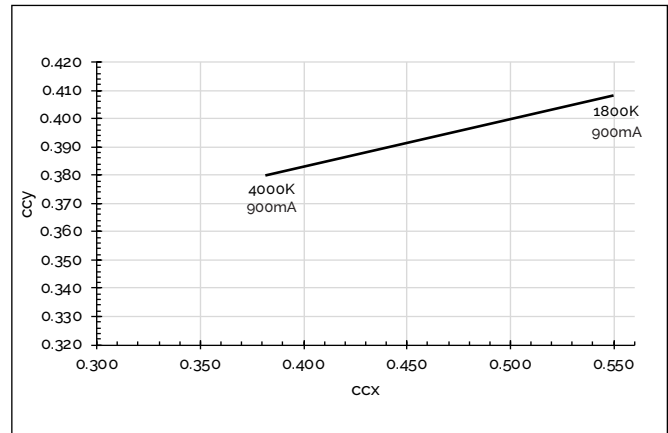
**Figure 8: CCT Tuning Range,  $T_c = 85^\circ\text{C}$**



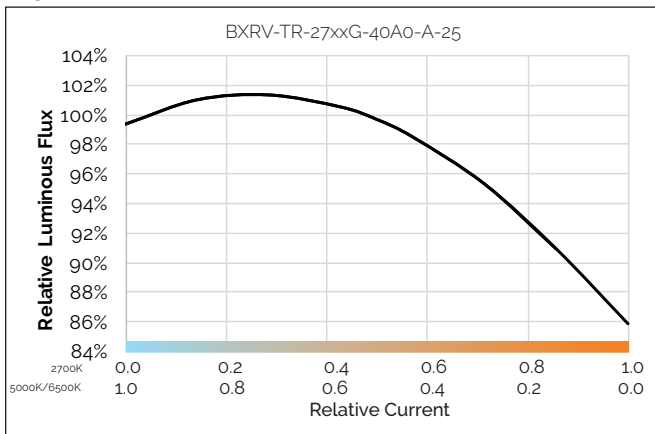
**Figure 9: CCT Tuning Range,  $T_c = 85^\circ\text{C}$**



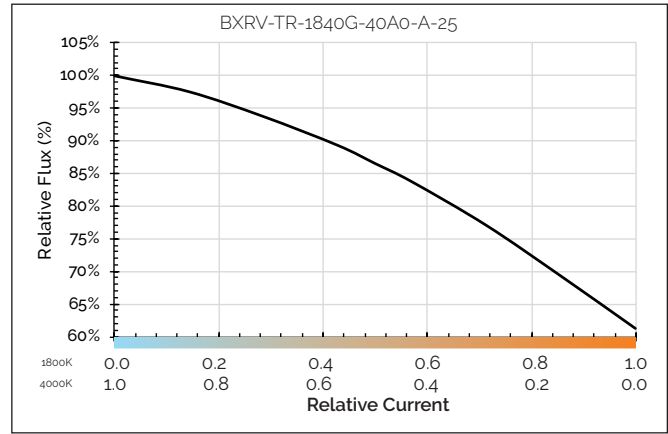
**Figure 10: CCT Tuning Range,  $T_c=85^\circ\text{C}$**



**Figure 11: Relative Flux vs. Relative Current**



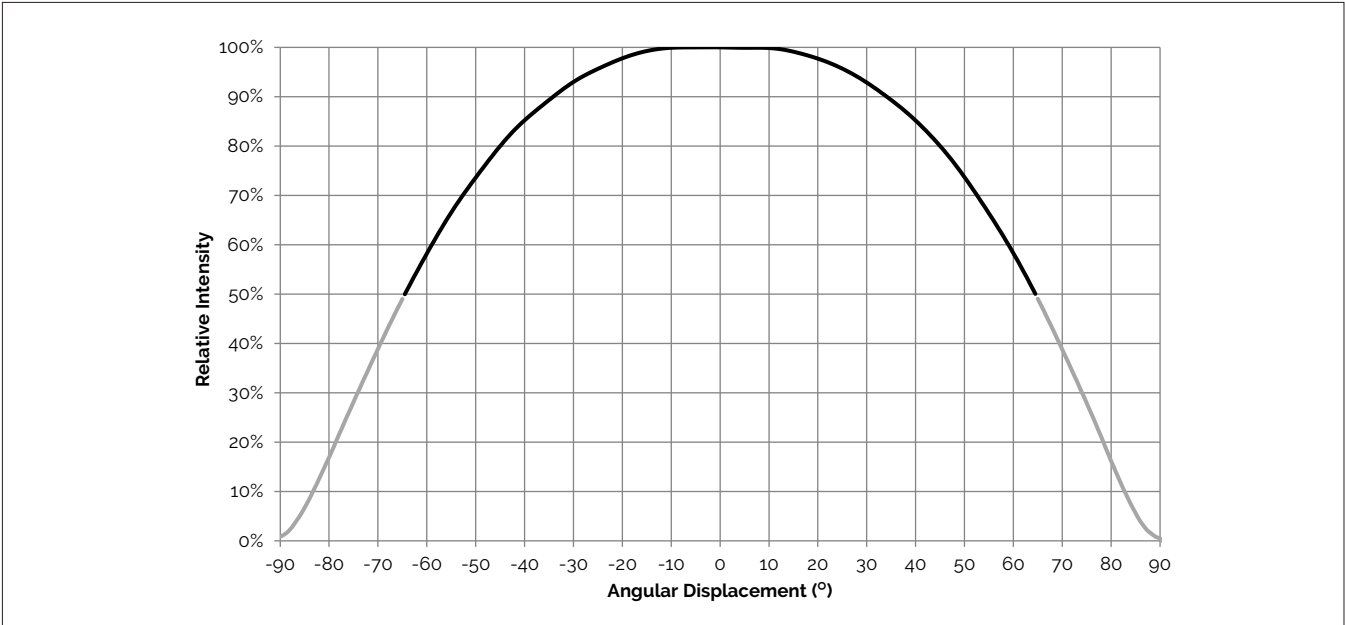
**Figure 12: Relative Flux vs. Relative Current**





# Typical Radiation Pattern

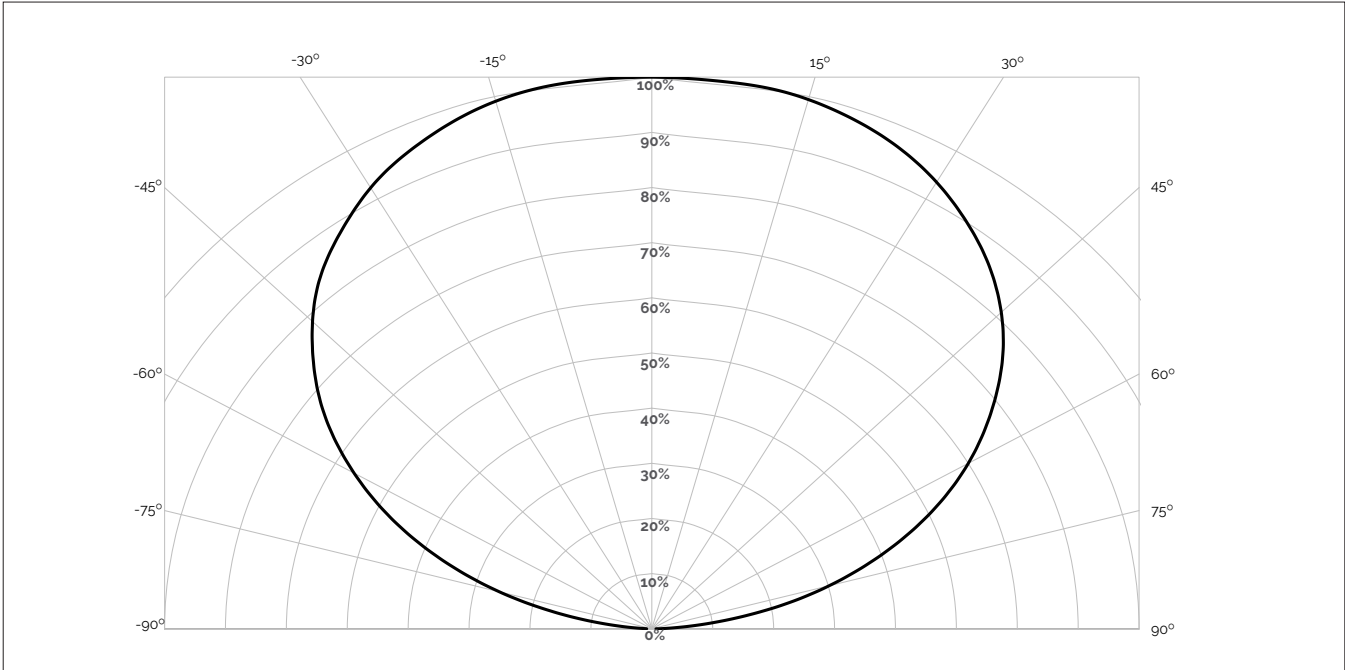
Figure 13: Typical Spatial Radiation Pattern



Notes for Figure 13:

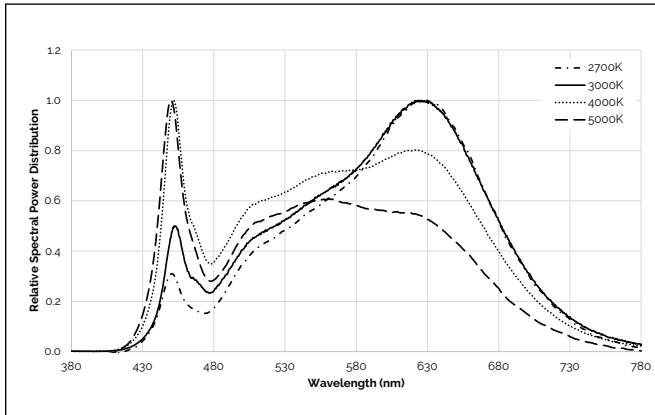
- 1. Typical viewing angle is 130°.
- 2. The viewing angle is defined as the off axis angle from the centerline where I<sub>v</sub> is ½ of the peak value.

Figure 14: Typical Polar Radiation Pattern



# Typical Color Spectrum

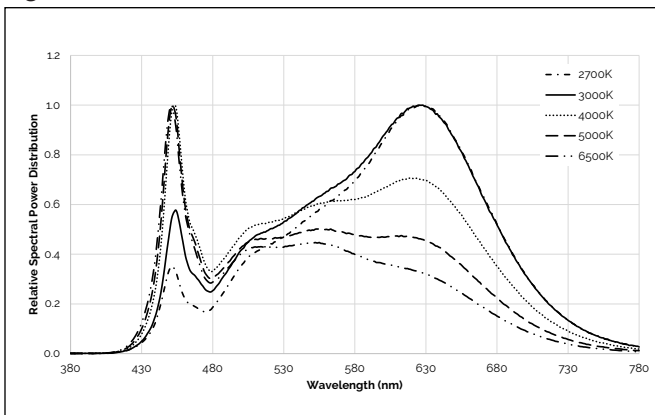
**Figure 15: 2700K - 5000K with 90 CRI**



Note for Figure 15:

1. Color spectra measured at nominal current and  $T_c = 25^\circ\text{C}$ .

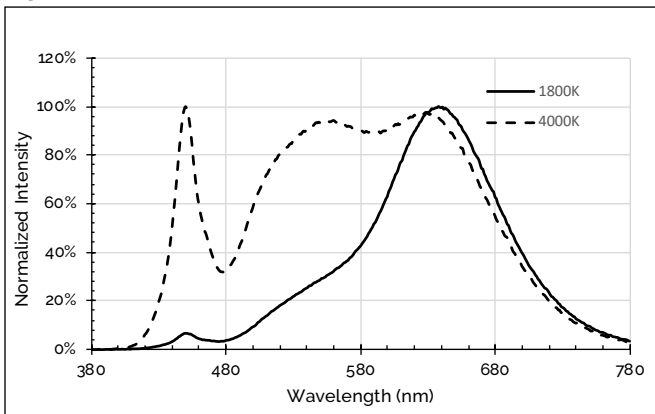
**Figure 16: 2700K - 6500K with 90 CRI**



Note for Figure 16:

1. Color spectra measured at nominal current and  $T_c = 25^\circ\text{C}$ .

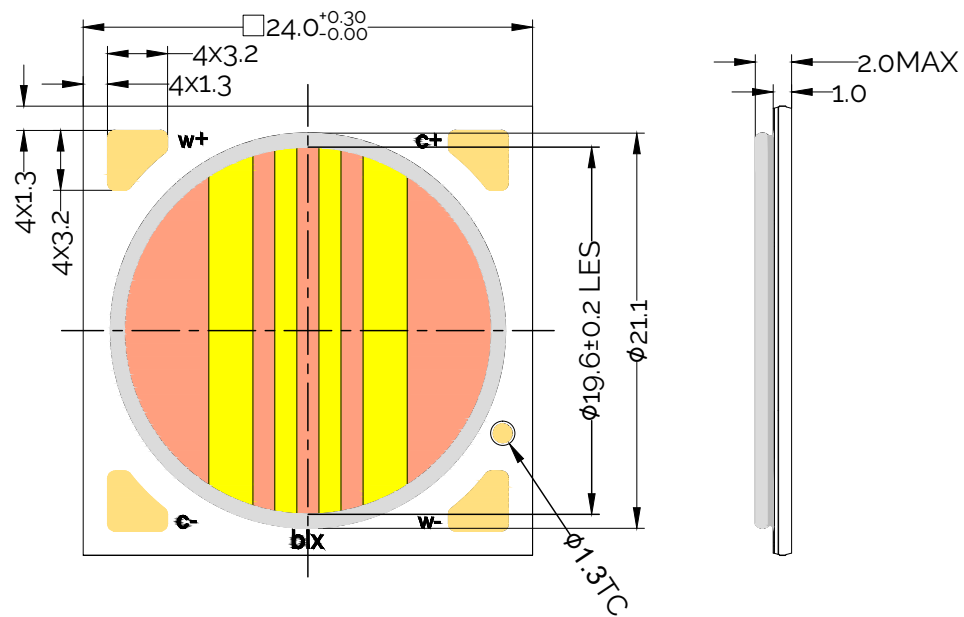
**Figure 17: 1800K - 4000K with 90 CRI**



Note for Figure 17:

1. Color spectra measured at nominal current and  $T_c = 25^\circ\text{C}$ .

**Figure 18: Drawing for Vesta Series Tunable White Gen 2 18mm Array**

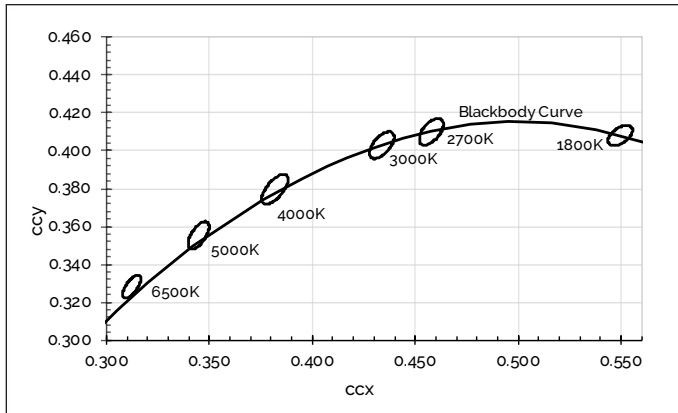


Notes for Figure 18:

1. Solder pads are labeled "+" to denote positive polarity and "-" to denote negative polarity. Solder pads have a gold surface finish.
2. Drawings are not to scale.
3. Drawing dimensions are in millimeters.
4. Unless otherwise specified, tolerances are  $\pm 0.10$ mm.
5. The optical center of the LED array is nominally defined by the mechanical center of the array.
6. Bridgelux maintains a flatness of 0.1 mm across the mounting surface of the array. Refer to Application Notes for product handling, mounting and heat sink recommendations.

# Color Binning Information

**Figure 19: Graph of Bins in xy Color Space, Tc=85C**



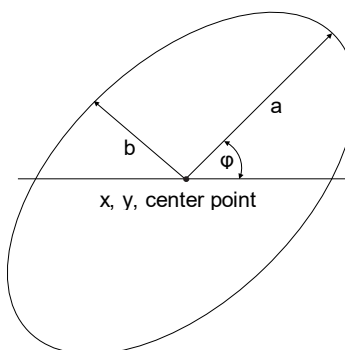
**Table 4: McAdam ellipse CCT color bin definitions for product operating at T<sub>c</sub> = 85°C**

CCT	Center Point	Bin Size	Axis a	Axis b	Rotation Angle
2700K	x=0.4578 y= 0.4101	3 SDCM	0.00810	0.00420	53.70°
5000K	x=0.3447 y=0.3553	3 SDCM	0.00822	0.00354	59.62°
6500K	x=0.3123 y=0.3282	3 SDCM	0.00690	0.00285	58.57°
1800K	x=0.5496 y=0.4081	5SDCM	0.01164	0.00655	40.00°
4000K	x=0.3818 y=0.3797	3SDCM	0.00939	0.00402	53.72°

Notes for Table 4:

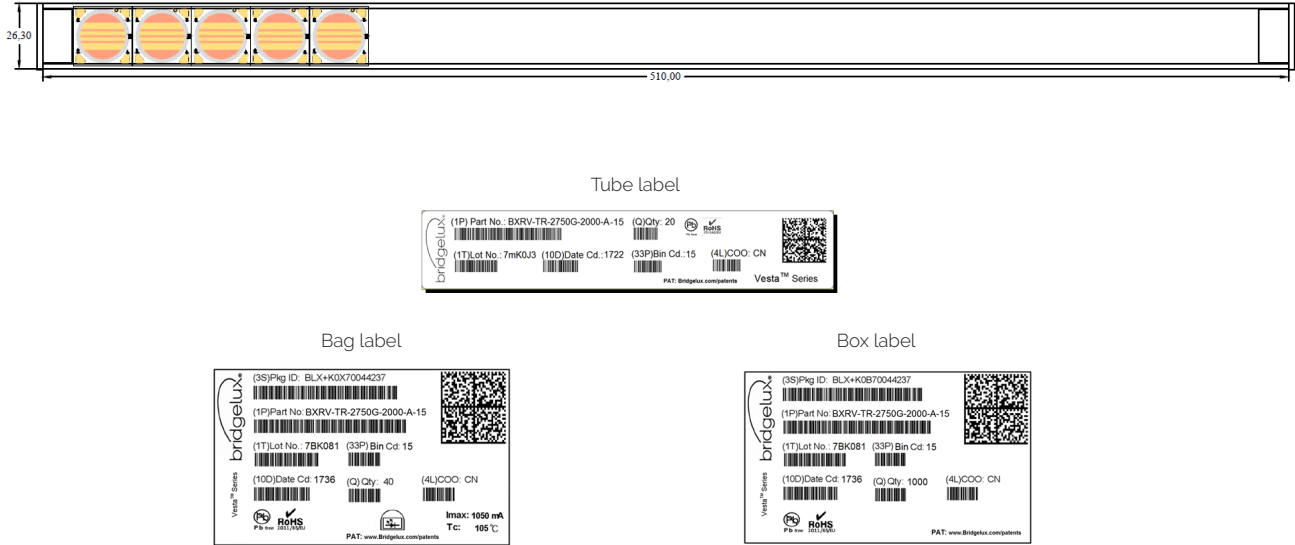
1. The x,y center points are the center points of the respective ANSI bins in the CIE 1931 xy Color Space
2. Products are binned at T<sub>c</sub>=85°C
3. Bridgelux maintains a tolerance of +/-0.007 on x and y color coordinates in the CIE 1931 Color Space

**Figure 20: Definition of the McAdam ellipse**



# Packaging and Labeling

**Figure 21: Vesta Series Tunable White 18mm Packaging and Labeling**



Notes for Figure 21:

1. Each tube holds 20 arrays.
2. Four tubes are sealed in an anti-static bag. Up to five such bags are placed in a box and shipped. Depending on quantities ordered, a bigger shipping box, containing four boxes will be used to ship products.
3. Each bag and box is to be labeled as shown above.
4. Dimensions for each tube are 510.0 mm (L) x 26.3 mm (W) x 9.5 mm (H). Dimensions for the anti-static bag are 100.0 mm (W) x 625.0 mm (L) x 0.1 mm (T) and that of the inner box are 58.7 mm (L) x 13.3 mm (W) x 7.9 mm (H).

**Figure 22: Product Labeling**

Bridgelux arrays have laser markings on the back side of the substrate to help with product identification. In addition to the product identification markings, Bridgelux arrays also contain markings for internal Bridgelux manufacturing use only. The image below shows which markings are for customer use and which ones are for Bridgelux internal use only. The Bridgelux internal manufacturing markings are subject to change without notice, however these will not impact the form, function or performance of the array.



# Design Resources

## Application Notes

Vesta Series Tunable White arrays are intended for use in dry, indoor applications. Bridgelux has developed a comprehensive set of application notes and design resources to assist customers in successfully designing with the Vesta Series product family of LED array products. For a list of resources under development, visit [www.bridgelux.com](http://www.bridgelux.com).

## Optical Source Models

Optical source models and ray set files are available for all Bridgelux products. For a list of available formats, visit [www.bridgelux.com](http://www.bridgelux.com).

## 3D CAD Models

Three dimensional CAD models depicting the product outline of all Bridgelux Vesta Series LED arrays are available in both IGS and STEP formats. Please contact your Bridgelux sales representative for assistance.

## LM80

Please contact your Bridgelux sales representative for more information.

# Precautions

## CAUTION: CHEMICAL EXPOSURE HAZARD

Exposure to some chemicals commonly used in luminaire manufacturing and assembly can cause damage to the LED array. Please consult Bridgelux Application Note for additional information.

## CAUTION: EYE SAFETY

Eye safety classification for the use of Bridgelux Vesta Series is in accordance with IEC/TR62778 specification IEC 62471 for the assessment of blue light hazard to light source and luminaires'. Vesta Series Tunable White arrays are classified as Risk Group 1 when operated at or below the maximum drive current. Please use appropriate precautions. It is important that employees working with LEDs are trained to use them safely.

## CAUTION: RISK OF BURN

Do not touch the Vesta Series LED array during operation. Allow the array to cool for a sufficient period of time before handling. The Vesta Series LED array may reach elevated temperatures such that could burn skin when touched.

## CAUTION

### CONTACT WITH LIGHT EMITTING SURFACE (LES)

Avoid any contact with the LES. Do not touch the LES of the LED array or apply stress to the LES (yellow phosphor resin area). Contact may cause damage to the LED array.

Optics and reflectors must not be mounted in contact with the LES (yellow phosphor resin area). Optical devices may be mounted on the top surface of the Vesta Series LED array. Use the mechanical features of the LED array housing, edges and/or mounting holes to locate and secure optical devices as needed.

# Disclaimers

## STANDARD TEST CONDITIONS

Unless otherwise stated, array testing is performed at the nominal drive current.

## MINOR PRODUCT CHANGE POLICY

The rigorous qualification testing on products offered by Bridgelux provides performance assurance. Slight cosmetic changes that do not affect form, fit, or function may occur as Bridgelux continues product optimization.

# About Bridgelux: Bridging Light and Life™

At Bridgelux, we help companies, industries and people experience the power and possibility of light. Since 2002, we've designed LED solutions that are high performing, energy efficient, cost effective and easy to integrate. Our focus is on light's impact on human behavior, delivering products that create better environments, experiences and returns—both experiential and financial. And our patented technology drives new platforms for commercial and industrial luminaires.

**For more information about the company, please visit**

**[bridgelux.com](http://bridgelux.com)**

**[twitter.com/Bridgelux](https://twitter.com/Bridgelux)**

**[facebook.com/Bridgelux](https://facebook.com/Bridgelux)**

**[youtube.com/user/Bridgelux](https://youtube.com/user/Bridgelux)**

**[linkedin.com/company/bridgelux](https://linkedin.com/company/bridgelux)**

**WeChat ID: BridgeluxInChina**



46430 Fremont Blvd  
Fremont, CA 94538 USA  
Tel (925) 583-8400  
**[www.bridgelux.com](http://www.bridgelux.com)**

© 2020 Bridgelux, Inc. All rights reserved 2020. Product specifications are subject to change without notice. Bridgelux, the Bridgelux stylized logo design and Vesta are registered trademarks of Bridgelux, Inc. All other trademarks are the property of their respective owners.

**Bridgelux Vesta Series Tunable White Gen 2 18mm Array Product Data Sheet DS353 Rev. F (09/2020)**