

SECTION Z-Z

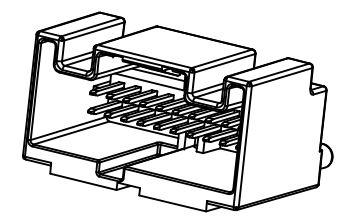

DATECODE, SEE NOTE 6

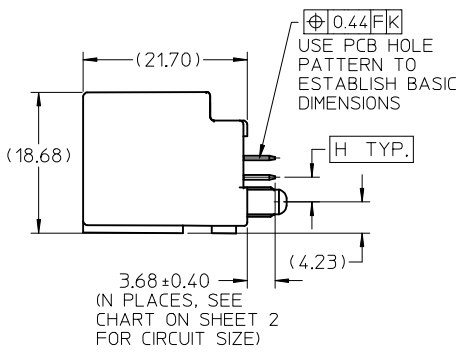
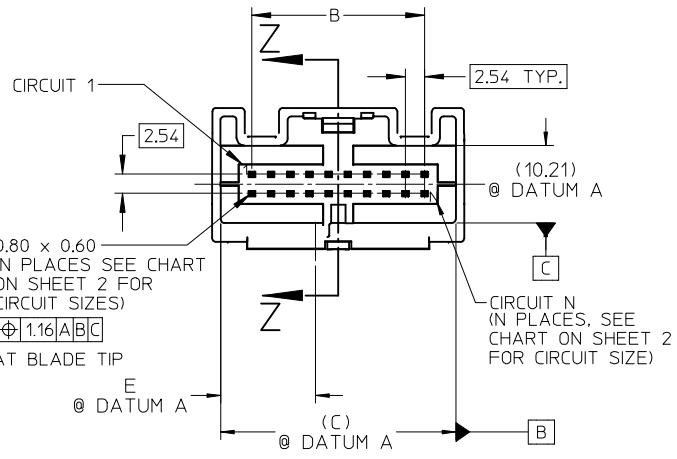

20 CIRCUIT VERTICAL HEADER ASSEMBLY SHOWN

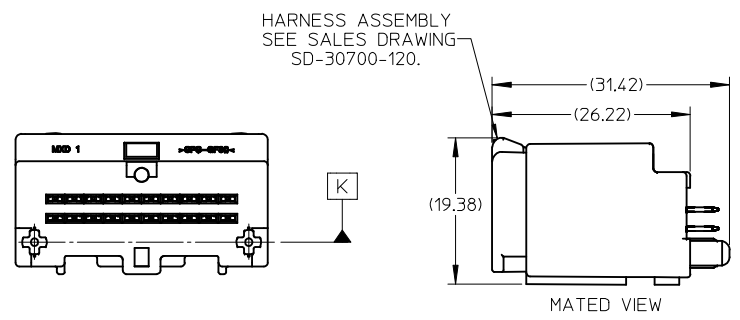

- NOTES:
- MATERIAL: HOUSING: SPS, GLASS FILLED, COLOR: SEE CHART. TERMINAL: COPPER ALLOY C26000.
 - FINISHES: TERMINAL: 150-250µm TIN (Sn) OVERALL; 125µm MIN NICKEL (Ni) UNDERPLATE OVERALL.
 - PRODUCT SPECIFICATION: PS-30700-0001
 - PACKAGING SPECIFICATION: TUBE: PK-30907-227, TRAY: PK-30907-260
 - MATES WITH: SERIES 30700, SEE SALES DRAWING SD-30700-120.
 - DATECODE DESCRIPTION:
 - 1ST DIGIT: MACHINE ID#
 - 2ND THROUGH 4TH DIGIT: DAY # OF THE CALENDAR YEAR (EXAMPLE: FEB, 3RD = "034")
 - 5TH DIGIT: LAST DIGIT OF THE CALENDAR YEAR (EXAMPLE: 1999 = "9")
 - 6TH THROUGH 7TH DIGIT: HOUR OF THE DAY.
 - RECOMMENDED OPTIONAL SCREW: M2 x 0.89, 6mm IN LENGTH, PAN COLLAR HEAD, 6 LOBE, TORQUE: 7 NEWTON CENTIMETERS

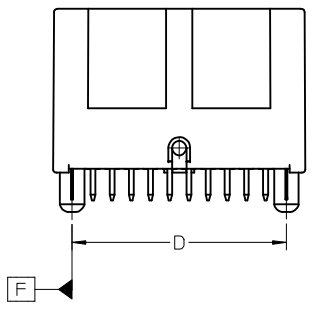

SEE ECN# UAU2001-0258 EC NO: UAU2017-0902 DRWN: JFISCHER02017/04/04 CHKD: APPR: RBAUMAN 2017/04/13	QUALITY SYMBOLS	GENERAL TOLERANCES (UNLESS SPECIFIED)		SCALE 2:1	DESIGN UNITS METRIC	THIRD ANGLE PROJECTION	REVISE ON CAD ONLY
	▼ -0 ∇ C -0		mm	INCH	DIMENSION STYLE MM ONLY		TITLE
		4 PLACES	± ---	± ---	DRAWN BY DATE		6-20 CIRCUIT VERTICAL HEADER ASSEMBLY
		3 PLACES	± ---	± ---	RCARLSON	01/03/20	
	2 PLACES	± 0.13	± ---	CHECKED BY DATE		MOLEX INCORPORATED	
	1 PLACE	± 0.25	± ---	CKRISHNA	01/03/27		
		ANGULAR ± 1 °		APPROVED BY DATE		MATERIAL NO.	DOCUMENT NO.
		DRAFT WHERE APPLICABLE		LGEIB	01/03/28	ENTER-PART	SD-30700-420
		MUST REMAIN WITHIN DIMENSIONS		THIS DRAWING CONTAINS INFORMATION THAT IS PROPRIETARY TO MOLEX INCORPORATED AND SHOULD NOT BE USED WITHOUT WRITTEN PERMISSION		SHEET NO. 1 OF 3	

BELOW VIEWS APPLY TO
30700-4067/8/9 PART NUMBERS

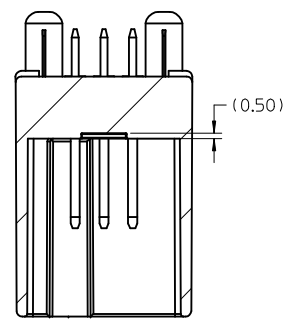

SECTION Y-Y
SCALE 3:1

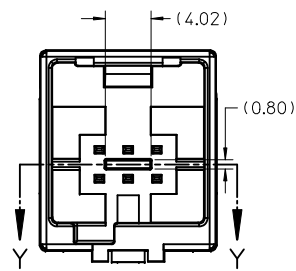

EC NO: UAU2017-0902 DRWN: JFISCHER02017/04/04 CHKD: APPR: RBAUMAN 2017/04/13	QUALITY SYMBOLS ▽ - 0 ∇ - 0	GENERAL TOLERANCES (UNLESS SPECIFIED)		SCALE 1:1	DESIGN UNITS METRIC	THIRD ANGLE PROJECTION	REVISE ON CAD ONLY		
		4 PLACES ± --- ± ---	mm INCH	DIMENSION STYLE MM ONLY		TITLE 6-20 CIRCUIT VERTICAL HEADER ASSEMBLY			
		3 PLACES ± --- ± ---	2 PLACES ± 0.13 ± ---	DRAWN BY R CARLSON	DATE 01/03/20	MOLEX INCORPORATED			
		1 PLACE ± 0.25 ± ---	ANGULAR ± 1 °	CHECKED BY CKRISHNA	DATE 01/03/27	MATERIAL NO. ENTER-PART	DOCUMENT NO. SD-30700-420	SHEET NO. 2 OF 3	
E4	DRAFT WHERE APPLICABLE MUST REMAIN WITHIN DIMENSIONS	APPROVED BY LGIEB	DATE 01/03/28	THIS DRAWING CONTAINS INFORMATION THAT IS PROPRIETARY TO MOLEX INCORPORATED AND SHOULD NOT BE USED WITHOUT WRITTEN PERMISSION					

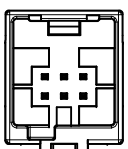

6 CIRCUIT

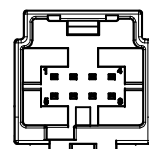

8 CIRCUIT

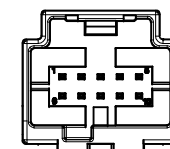

10 CIRCUIT

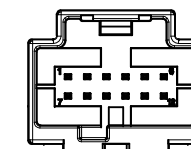

12 CIRCUIT

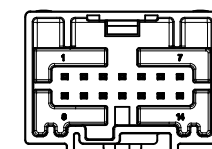

14 CIRCUIT

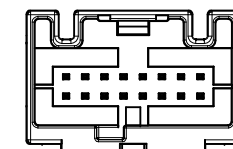

16 CIRCUIT

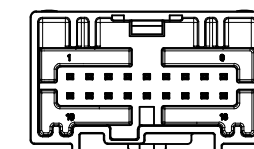

18 CIRCUIT

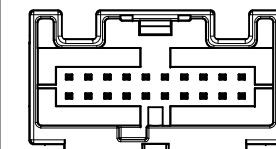

20 CIRCUIT

PACKAGING		POLARIZATION OPTIONS & CIRCUIT SIZE		PRODUCT DIMENSIONS								HOUSING COLOR	STATUS
ASSEMBLY P/N TRAY PACKED	ASSEMBLY P/N TUBE PACKED	VERTICAL HEADER ASSEMBLY (POLARIZATION OPTIONS)	CIRCUIT SIZE	(A)	B	(C)	D	E	H				
30700-4200	30700-4204	POLARIZATION OPTION #1	20	33.38	22.86	31.14	28.38	12.57	3.20	GRAY	RELEASED		
30700-4201	30700-4205	POLARIZATION OPTION #2	20	33.38	22.86	31.14	28.38	15.57		BLACK	RELEASED		
30700-4202	30700-4206	POLARIZATION OPTION #3	20	33.38	22.86	31.14	28.38	18.57		NATURAL (CREAM)	RELEASED		
30700-4187	---	POLARIZATION OPTION #1	18	30.84	20.32	28.60	25.84	11.31	3.25	GRAY	RELEASED		
30700-4188	---	POLARIZATION OPTION #2	18	30.84	20.32	28.60	25.84	14.31		BLACK	RELEASED		
30700-4189	---	POLARIZATION OPTION #3	18	30.84	20.32	28.60	25.84	17.31		NATURAL (CREAM)	RELEASED		
30700-4160	30700-4164	POLARIZATION OPTION #1	16	28.30	17.78	26.06	23.30	10.04	3.20	GRAY	RELEASED		
30700-4161	30700-4165	POLARIZATION OPTION #2	16	28.30	17.78	26.06	23.30	13.04		BLACK	RELEASED		
30700-4162	30700-4166	POLARIZATION OPTION #3	16	28.30	17.78	26.06	23.30	16.04		NATURAL (CREAM)	RELEASED		
30700-4147	---	POLARIZATION OPTION #1	14	25.76	15.24	23.52	20.76	8.77	3.25	GRAY	RELEASED		
30700-4148	---	POLARIZATION OPTION #2	14	25.76	15.24	23.52	20.76	11.77		BLACK	RELEASED		
30700-4149	---	POLARIZATION OPTION #3	14	25.76	15.24	23.52	20.76	14.77		NATURAL (CREAM)	RELEASED		
30700-4120	30700-4124	POLARIZATION OPTION #1	12	23.22	12.70	20.98	18.22	7.50	3.20	GRAY	RELEASED		
30700-4121	30700-4125	POLARIZATION OPTION #2	12	23.22	12.70	20.98	18.22	10.50		BLACK	RELEASED		
30700-4122	30700-4126	POLARIZATION OPTION #3	12	23.22	12.70	20.98	18.22	13.50		NATURAL (CREAM)	RELEASED		
30700-4100	30700-4104	POLARIZATION OPTION #1	10	20.68	10.16	18.44	15.68	6.23	3.20	GRAY	RELEASED		
30700-4101	30700-4105	POLARIZATION OPTION #2	10	20.68	10.16	18.44	15.68	9.23		BLACK	RELEASED		
30700-4102	30700-4106	POLARIZATION OPTION #3	10	20.68	10.16	18.44	15.68	12.23		NATURAL (CREAM)	RELEASED		
30700-4080	30700-4084	POLARIZATION OPTION #1	8	18.14	7.62	15.90	13.14	4.96	3.20	GRAY	RELEASED		
30700-4081	30700-4085	POLARIZATION OPTION #2	8	18.14	7.62	15.90	13.14	7.96		BLACK	RELEASED		
30700-4082	30700-4086	POLARIZATION OPTION #3	8	18.14	7.62	15.90	13.14	10.96		NATURAL (CREAM)	RELEASED		
30700-4060	30700-4064	POLARIZATION OPTION #1	6	15.60	5.08	13.36	10.60	3.69	3.20	GRAY	RELEASED		
30700-4061	30700-4065	POLARIZATION OPTION #2	6	15.60	5.08	13.36	10.60	6.69		BLACK	RELEASED		
30700-4062	30700-4066	POLARIZATION OPTION #3	6	15.60	5.08	13.36	10.60	9.69		NATURAL (CREAM)	RELEASED		

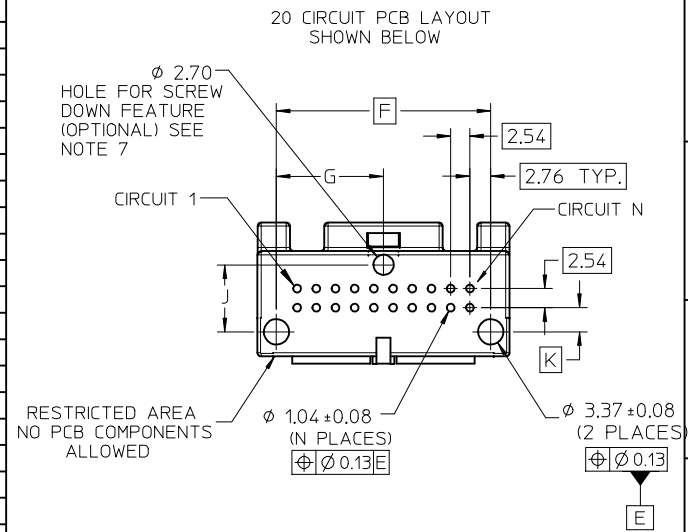

PCB LAYOUT: COMPONENT SIDE
RECOMMENDED PCB THICKNESS: 1.57±0.17

PCB LAYOUT DIMENSIONS				
CIRCUIT SIZE (N)	F	G	J	K
20	28.38	14.19	8.87	3.20
18	25.84	12.92	8.94	3.25
16	23.30	11.65	8.87	3.20
14	20.76	10.38	8.94	3.25
12	18.22	9.11	8.87	3.20
10	15.68	7.84	8.87	3.20
8	13.14	6.57	8.87	3.20
6	10.60	5.30	8.87	3.20

30700-4067/8/9 PART NUMBER DENOTES HDAC WITH MOAT FEATURE													
PACKAGING		POLARIZATION OPTIONS & CIRCUIT SIZE		PRODUCT DIMENSIONS								HOUSING COLOR	STATUS
ASSEMBLY P/N TRAY PACKED	ASSEMBLY P/N TUBE PACKED	VERTICAL HEADER ASSEMBLY (POLARIZATION OPTIONS)	CIRCUIT SIZE	(A)	B	(C)	D	E					
30700-4067	TBD	POLARIZATION OPTION #1	6	15.60	5.08	13.36	10.60	3.69	GRAY	RELEASED			
30700-4068	TBD	POLARIZATION OPTION #2	6	15.60	5.08	13.36	10.60	6.69	BLACK	RELEASED			
30700-4069	TBD	POLARIZATION OPTION #3	6	15.60	5.08	13.36	10.60	9.69	NATURAL (CREAM)	RELEASED			

SEE ECN# UAU2001-0258 EC NO: UAU2017-0902 DRWN: JFISCHER02017/04/04 CHKD: RBAUMAN 2017/04/13 APPR: RBAUMAN 2017/04/13	QUALITY SYMBOLS ▽ - 0 ▽ - 0	GENERAL TOLERANCES (UNLESS SPECIFIED) mm INCH		SCALE 2:1	DESIGN UNITS METRIC	THIRD ANGLE PROJECTION	REVISE ON CAD ONLY		
		4 PLACES ± --- ± ---	3 PLACES ± --- ± ---	DIMENSION STYLE MM ONLY		TITLE			
		2 PLACES ± 0.13 ± ---	1 PLACE ± 0.25 ± ---	DRAWN BY RCARLSON		DATE 01/03/20	MOLEX INCORPORATED ENTER-PART SD-30700-420		
		ANGULAR ± 1 °		CHECKED BY CKRISHNA		DATE 01/03/27			
DRAFT WHERE APPLICABLE		APPROVED BY LGIEB		DATE 01/03/28	MATERIAL NO.	DOCUMENT NO.	SHEET NO.		
MUST REMAIN WITHIN DIMENSIONS		THIS DRAWING CONTAINS INFORMATION THAT IS PROPRIETARY TO MOLEX INCORPORATED AND SHOULD NOT BE USED WITHOUT WRITTEN PERMISSION						3 OF 3	