

## TRS5-80BLRVU

Aliases (USEH80BLR00000)

KEMET, TRS, Thermal Reed Switch, Axial, 2.5C Temperature Accuracy, High Reliability, High-Speed Response, Long Operational Life, Excellent Environmental Durability, High Temperature Accuracy, 80°C, Break

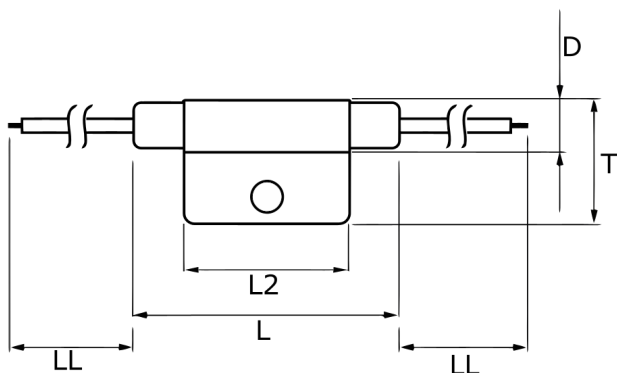

Click [here](#) for the 3D model.

### Dimensions

D	8.2mm MAX
L	50mm MAX
L2	29mm MAX
T	20mm MAX
LL	200mm NOM

### Packaging Specifications

Packaging	Rubberband Box
Packaging Quantity	600
Component Weight	8.5 g

### General Information

Series	TRS
Type	Thermal Reed Switch
Style	Axial
Description	Thermal Reed Switch
Features	High Reliability, High-Speed Response, Long Operational Life, Excellent Environmental Durability, High Temperature Accuracy
Lead	Cables
RoHS	Yes
REACH	Yes
Qualifications	UL, CSA, VDE

### Specifications

Switching Temperature	80C +/-2.5C
Temperature Range	-20/+130°C
Contact Type	Break
Voltage AC	264 VAC MAX (Opening/Closing)
Current	0.275 Amps MAX (Make/Break), 1 mAmps MIN (5VDC, Opening/Closing)
Resistance	150 mOhms MAX (Contact Resistance)
Max Opening/Closing Power	60.5 W (AC/DC)
Max Opening/Closing Voltage	264 V (AC)