

LTM2810 SPI/Digital or I²C μ Module Isolator with Transformer Driver

DESCRIPTION

Demonstration circuit 2832A is a serial peripheral interface bus (SPI) or inter-IC bus (I²C) μ Module isolator with integrated transformer driver featuring the LTM[®]2810. Isolated power is generated by the integrated transformer driver and transformer included on the demo board. It

communicates all necessary signaling across the isolation barrier through Analog Devices isolator μ Module technology.

[Design files for this circuit board are available.](#)

All registered trademarks and trademarks are the property of their respective owners.

PERFORMANCE SUMMARY Specifications are at T_A = 25°C

SYMBOL	PARAMETER	CONDITIONS	MIN	TYP	MAX	UNITS
V _{CC} /V _L	Input Supply Range		3.0		5.5	V
V _{IN}	Isolated Supply Input Range	DC/DC Enable = OFF	3.6		38	V
f _{MAX}	Maximum Data Rate	Digital Input → Digital Output	10			MHz
		LTM2810-S, Bidirectional Communication	4			MHz
		LTM2810-S, Unidirectional Communication	8			MHz
		LTM2810-I	400			kHz
	Transformer Driver Frequency			2		MHz
	Transformer Driver Current Limit			400		mA
V _{IORM}	Maximum Working Insulation Voltage	GND to GND2	1600			V _{DC}
			1000			V _{RMS}
	Common Mode Transient Immunity		50			kV/ μ s

OPERATING PRINCIPLES

The LTM2810 requires a single external power supply for operation, it provides power for both the signal interface and transformer driver. Jumpers allow configuration of the transformer for optimum performance based on the input voltage and output voltage.

Isolation is maintained by the separation of GND and GND2 where significant operating voltages and transients can exist without affecting the operation of the LTM2810.

The ON and/or ON2 pins enable or shut down the LTM2810, both are biased to their respective logic supply voltage (enabled) by default.

Demo circuit 2832A is available in two configurations supporting both versions of the LTM2810. The SPI version is DC2832A-A and the I²C version is DC2832A-B.

OPERATING PRINCIPLES

DC/DC Converter

For optimum efficiency the DC/DC transformer may be configured based on the input operating voltage on V_{CC}/V_L and the desired output voltage on V_{L2} . V_L and V_{L2} are the logic supply voltages that the digital I/O are referenced to. The isolated logic voltage (V_{L2}) is by default 5V but may be adjusted to as low as 3V by installing resistors R10 and R11.

$$V_{L2} = 0.6V(1+R11/R10), R10 \leq 13k\Omega$$

Table 1 details the recommended jumper settings versus input and output operating voltage.

Table 1.

Input Voltage	Output Voltage	PRI CFG	SEC CFG	R10	R11
3.0 to 3.6	5	1x	2x	Open	Open
4.5 to 5.5	5	1x	1x	Open	Open
3.0 to 3.6	3.3	1x	1x	13k	56.2k
4.5 to 5.5	3.3	2x	1x	13k	56.2k

The DC/DC converter may be disabled by setting the DC/DC enable jumper to the OFF position. The isolated side of the LTM2810 is then powered by connecting an external supply voltage to V_{IN} . The LTM2810 includes an internal LDO to regulate V_{L2} to 5V nominally, or V_{L2} may be driven directly from a supply voltage of 3V to 5.5V.

On board LEDs provide indication of which supply voltages are connected and on.

Digital I/O

All inputs on the demo board are biased either high or low to prevent floating inputs. Check the schematic carefully to ensure signals are at the correct potential for the intended application. Surface mount test points and through holes are provided to connect or monitor each input and output.

SPI (DC2832A-A, LTM2810-S)

SPI signaling is typically configured by defining the digital pins as follows:

Logic side:

- D11 = SCK (in),
- D12 = SDI (in),
- D13 = $\overline{DO1E}$ = CS (in), and
- DO1 = SDO (out).

If SDO is not shared with other devices, then $\overline{DO1E}$ may always be enabled.

Isolated side:

- O1 = SCK (out),
- O2N = O2P = SDI (out),
- O3 = CS (out), and
- I1 = SDO (in).

I²C (DC2832A-B, LTM2810-I)

$\overline{DO1E}$ and $\overline{O1E}$ are not functional for the LTM2810-I, their respective outputs are always active. DO2P and O2P are also inactive pins.

Function specific pins (I²C) are labeled on the demo board.

Logic side:

- D11 = SCL (in),
- D12 = DO2N = SDA (bidirectional).

Isolated side:

- O1 = SCL2 (out),
- O2N = I2 = SDA2 (bidirectional).

OPERATING PRINCIPLES

Radiated Emissions

The demo circuit has been designed and optimized for low RF emissions. EMI mitigation techniques used include the following.

1. Board/ground plane size has been minimized. This reduces the dipole antenna formed between the logic side and isolated side ground planes.
2. A combination of low ESL and high ESR decoupling is used. A low ESL ceramic capacitor is located close to the module minimizing high frequency noise conduction. A high ESR tantalum capacitor is included to minimize board resonances and prevent voltage spikes due to hot plugging of the supply voltage.
3. Capacitors (C2 and C4) added to the transformer drive lines. These capacitors reduce the drive edge rate and in turn reduce the common mode current injected to the isolated side via the transformer parasitic capacitance. The selected capacitors increase the quiescent current by approximately 50% while still providing reasonable EMI reduction.
4. A discrete bridge capacitor (C5) mounted between GND2 and GND. The discrete capacitor provides a return path for common mode current, and EMI attenuation at frequencies below approximately 400MHz.

EMI performance is shown in Figure 1, measured using a Gigahertz Transverse Electromagnetic (GTEM) cell and method detailed in IEC 61000-4-20, "Testing and Measurement Techniques—Emission and Immunity Testing in Transverse Electromagnetic Waveguides."

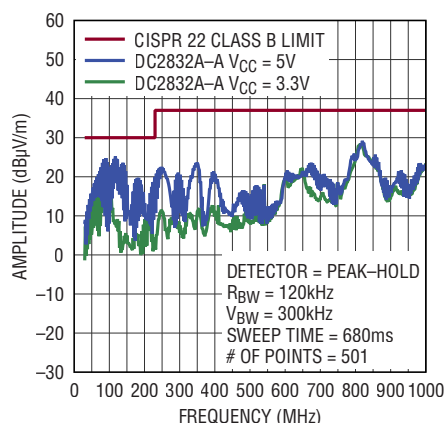

Figure 1. DC2832A Radiated Emissions

QUICK START PROCEDURE

Demonstration circuit 2832A is easy to set up and evaluate the performance of the LTM2810. Refer to Figure 1 for proper measurement equipment setup and follow the procedure below.

NOTE: When measuring the input or output voltage ripple or high speed signals, care must be taken to avoid a long ground lead on the oscilloscope probe.

1. Install jumpers as shown in Figure 2 and the schematic diagram.

2. With power off, connect the input power supply to V_{CC}/V_L to GND as shown.

3. Turn on the power at the input.

NOTE: Make sure that the input voltage does not exceed 6V.

4. Configure jumpers or connect signals to test points or through holes as appropriate.

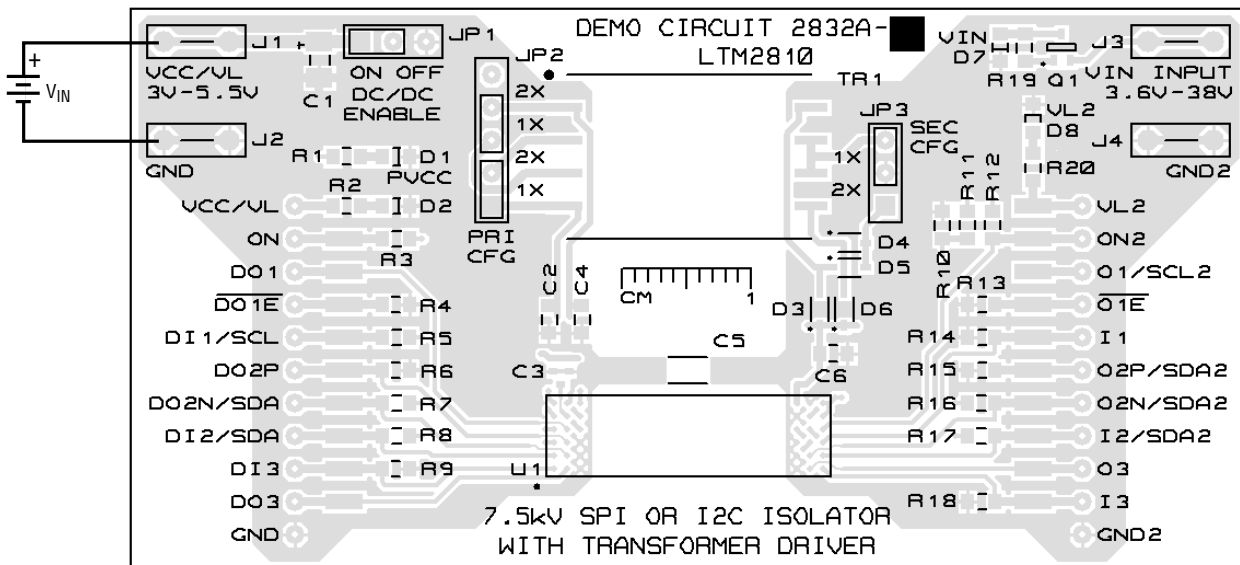
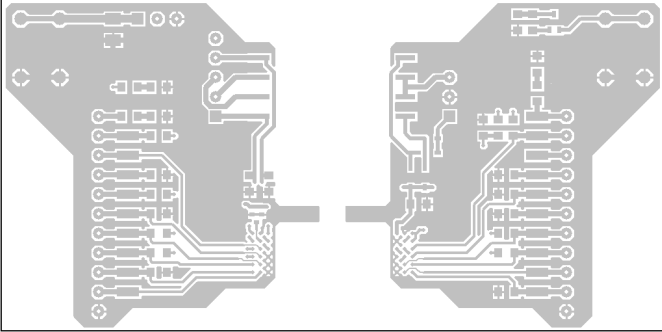

Figure 2. Demo Board Setup

DC2832A F02

PCB LAYOUT



Top Copper

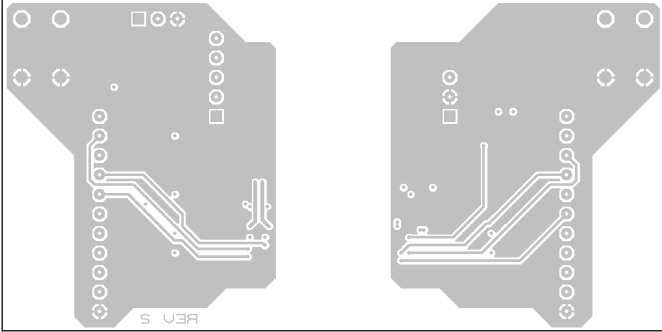

Bottom Copper

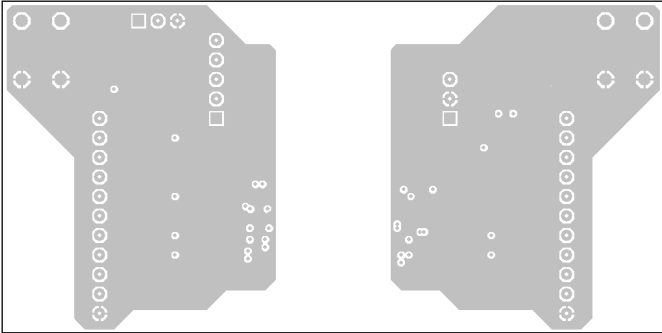

Inner Layer 1

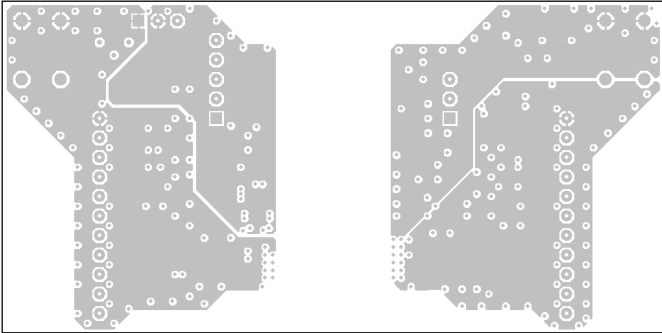

Inner Layer 2

DEMO MANUAL DC2832A

PARTS LIST

ITEM	QTY	REFERENCE	PART DESCRIPTION	MANUFACTURER/PART NUMBER
DC2832A-A Required Circuit Components				
1	1	U1	I.C., LTM2810(C,I,H)Y-S	ANALOG DEVICES, LTM2810(C,I,H)Y-S#PBF
DC2832A-B Required Circuit Components				
1	1	U1	I.C., LTM2810(C,I,H)Y-I	ANALOG DEVICES, LTM2810(C,I,H)Y-I#PBF
Hardware: For Demo Board Only				
2	1	C1	CAP., TANT 15µF 10V 20% 3216	AVX, TAJA156M010RNJ
3	2	C2, C4	CAP., CER 470pF 50V 10% 0805	AVX, 08055A471KAT2A
4	1	C3	CAP., CER 4.7µF 10V 20% 0805-3	MURATA, NFM21PC475B1A3D
5	1	C5	CAP., CER 100pF 3.15kV 5% 1808	MURATA, GRM42A7U3F101JW31L
6	1	C6	CAP., CER 2.2µF 50V 10% 0805	TDK, C2012X7R1H225K125AC
7	2	D1, D7	LED, YELLOW 0805	WURTH, 150080YS75000
8	2	D2, D8	LED, BLUE 0805	WURTH, 150080BS75000
9	4	D3-6	DIODE, SCHOTTKY 100V SOD-323F	NEXPERIA, BAT46WJ,, 115
10	4	J1-4	HTSNK ANCHOR LOOP 2-PIN 0.2"	AAVID, 125700D00000G
11	4	JP1-3	CONN., SHUNT 2-POS 2.54mm	WURTH, 60900213421
12	2	JP1, JP3	CONN., HEADER 1x3 2.54mm	WURTH, 61300311121
13	1	JP2	CONN., HEADER 1x5 2.54mm	SAMTEC, TSW-105-07-L-S
14	1	Q1	XSTR., JFET N-CH 55V SC-85	PANASONIC, DSK5J01P0L
15	1	R1	RES., CHIP 4.75k 1% 0805	VISHAY, CRCW08054K75FKEA
16	2	R2, R20	RES., CHIP 6.2k 1% 0805	VISHAY, CRCW08056K20FKEA
17	8	R3-4, R6, R9, R12-14, R18	RES., CHIP 20k 1% 0805	VISHAY, CRCW080520K0FKEA
18	1	R5	RES., CHIP 4.99k 1% 0805	VISHAY, CRCW08054K99FKEA
19	2	R7-8	RES., CHIP 10k 1% 0805	VISHAY, CRCW080510K0FKEA
20	2	R16-17	RES., CHIP 49.9k 1% 0805	VISHAY, CRCW080549K9FKEA
21	1	R19	RES., CHIP 301 1% 0805	VISHAY, CRCW0805301RFKEA
22	1	TR1	TRANSFORMER 1:2 7.5kV	WURTH, 750316917
23	19	TP1-19	TEST POINT, MINI SMT	KEYSTONE, 5015

SCHEMATIC DIAGRAM

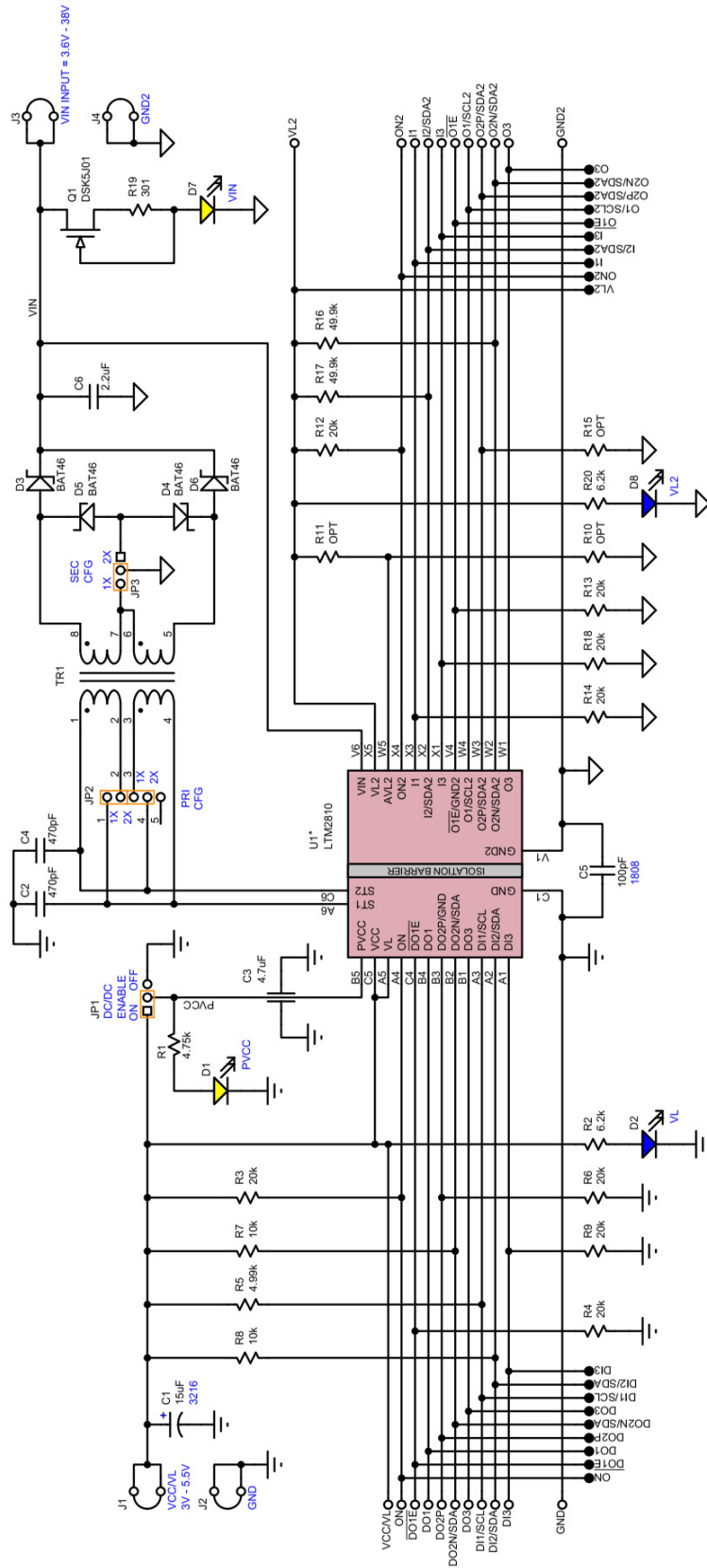



ESD Caution

ESD (electrostatic discharge) sensitive device. Charged devices and circuit boards can discharge without detection. Although this product features patented or proprietary protection circuitry, damage may occur on devices subjected to high energy ESD. Therefore, proper ESD precautions should be taken to avoid performance degradation or loss of functionality.

Legal Terms and Conditions

By using the evaluation board discussed herein (together with any tools, components documentation or support materials, the "Evaluation Board"), you are agreeing to be bound by the terms and conditions set forth below ("Agreement") unless you have purchased the Evaluation Board, in which case the Analog Devices Standard Terms and Conditions of Sale shall govern. Do not use the Evaluation Board until you have read and agreed to the Agreement. Your use of the Evaluation Board shall signify your acceptance of the Agreement. This Agreement is made by and between you ("Customer") and Analog Devices, Inc. ("ADI"), with its principal place of business at One Technology Way, Norwood, MA 02062, USA. Subject to the terms and conditions of the Agreement, ADI hereby grants to Customer a free, limited, personal, temporary, non-exclusive, non-sublicensable, non-transferable license to use the Evaluation Board FOR EVALUATION PURPOSES ONLY. Customer understands and agrees that the Evaluation Board is provided for the sole and exclusive purpose referenced above, and agrees not to use the Evaluation Board for any other purpose. Furthermore, the license granted is expressly made subject to the following additional limitations: Customer shall not (i) rent, lease, display, sell, transfer, assign, sublicense, or distribute the Evaluation Board; and (ii) permit any Third Party to access the Evaluation Board. As used herein, the term "Third Party" includes any entity other than ADI, Customer, their employees, affiliates and in-house consultants. The Evaluation Board is NOT sold to Customer; all rights not expressly granted herein, including ownership of the Evaluation Board, are reserved by ADI. CONFIDENTIALITY. This Agreement and the Evaluation Board shall all be considered the confidential and proprietary information of ADI. Customer may not disclose or transfer any portion of the Evaluation Board to any other party for any reason. Upon discontinuation of use of the Evaluation Board or termination of this Agreement, Customer agrees to promptly return the Evaluation Board to ADI. ADDITIONAL RESTRICTIONS. Customer may not disassemble, decompile or reverse engineer chips on the Evaluation Board. Customer shall inform ADI of any occurred damages or any modifications or alterations it makes to the Evaluation Board, including but not limited to soldering or any other activity that affects the material content of the Evaluation Board. Modifications to the Evaluation Board must comply with applicable law, including but not limited to the RoHS Directive. TERMINATION. ADI may terminate this Agreement at any time upon giving written notice to Customer. Customer agrees to return to ADI the Evaluation Board at that time. LIMITATION OF LIABILITY. THE EVALUATION BOARD PROVIDED HEREUNDER IS PROVIDED "AS IS" AND ADI MAKES NO WARRANTIES OR REPRESENTATIONS OF ANY KIND WITH RESPECT TO IT. ADI SPECIFICALLY DISCLAIMS ANY REPRESENTATIONS, ENDORSEMENTS, GUARANTEES, OR WARRANTIES, EXPRESS OR IMPLIED, RELATED TO THE EVALUATION BOARD INCLUDING, BUT NOT LIMITED TO, THE IMPLIED WARRANTY OF MERCHANTABILITY, TITLE, FITNESS FOR A PARTICULAR PURPOSE OR NON-INFRINGEMENT OF INTELLECTUAL PROPERTY RIGHTS. IN NO EVENT WILL ADI AND ITS LICENSORS BE LIABLE FOR ANY INCIDENTAL, SPECIAL, INDIRECT, OR CONSEQUENTIAL DAMAGES RESULTING FROM CUSTOMER'S POSSESSION OR USE OF THE EVALUATION BOARD, INCLUDING BUT NOT LIMITED TO LOST PROFITS, DELAY COSTS, LABOR COSTS OR LOSS OF GOODWILL. ADI'S TOTAL LIABILITY FROM ANY AND ALL CAUSES SHALL BE LIMITED TO THE AMOUNT OF ONE HUNDRED US DOLLARS (\$100.00). EXPORT. Customer agrees that it will not directly or indirectly export the Evaluation Board to another country, and that it will comply with all applicable United States federal laws and regulations relating to exports. GOVERNING LAW. This Agreement shall be governed by and construed in accordance with the substantive laws of the Commonwealth of Massachusetts (excluding conflict of law rules). Any legal action regarding this Agreement will be heard in the state or federal courts having jurisdiction in Suffolk County, Massachusetts, and Customer hereby submits to the personal jurisdiction and venue of such courts. The United Nations Convention on Contracts for the International Sale of Goods shall not apply to this Agreement and is expressly disclaimed.