

NOTES:

1. MATERIAL:  
 BODY - GRAY ABS  
 COVER - GRAY ABS OR CLEAR (-C SUFFIX) POLYCARBONATE
2. UL508 / NEMA TYPE 4X & 6P WITH IP-67 TUV RATING & UL-94 HB
3. POURED CONTINUOUS GASKET
4. DIMENSIONS ARE INCH[MM]
5. OPTIONAL ACCESSORIES:  
 16 GA INTERNAL MOUNTING PLATE OR ABS  
 EXTERNAL MOUNTING BRACKETS - NBX-10922, PIP-117-PMB  
 PLASTIC INTERNAL PANEL - PTX-18491-P

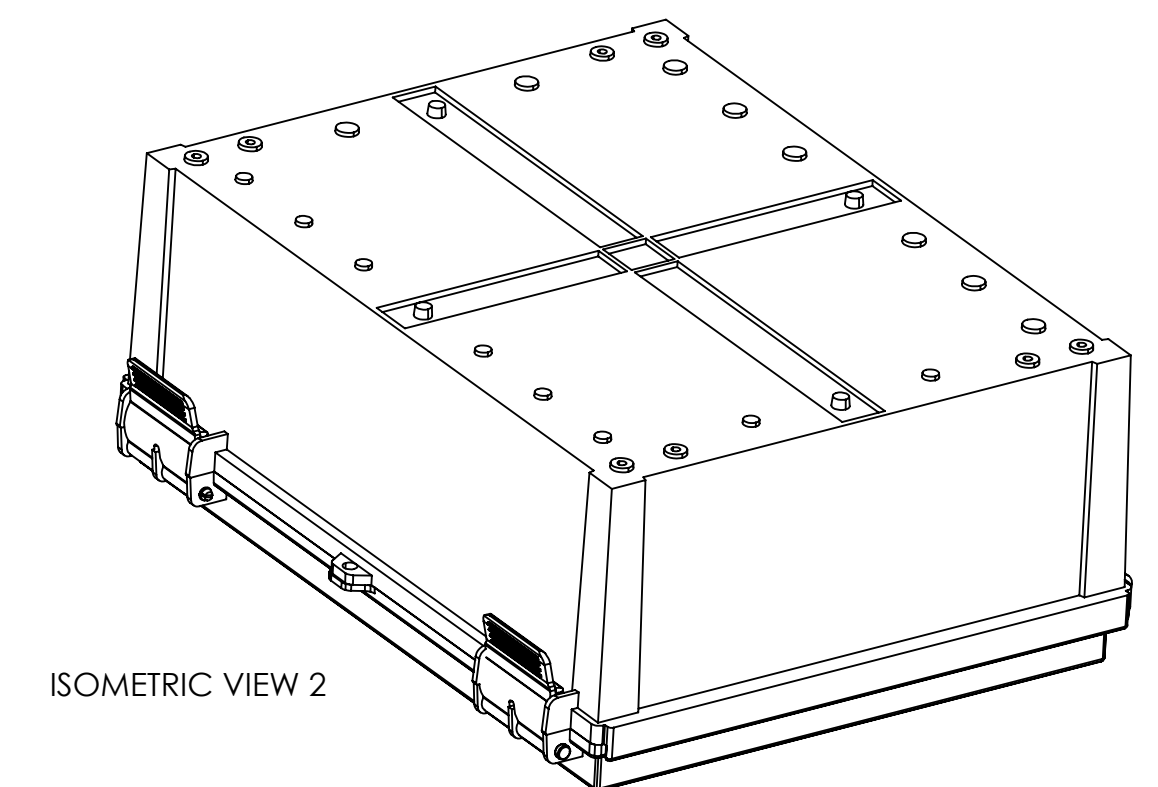
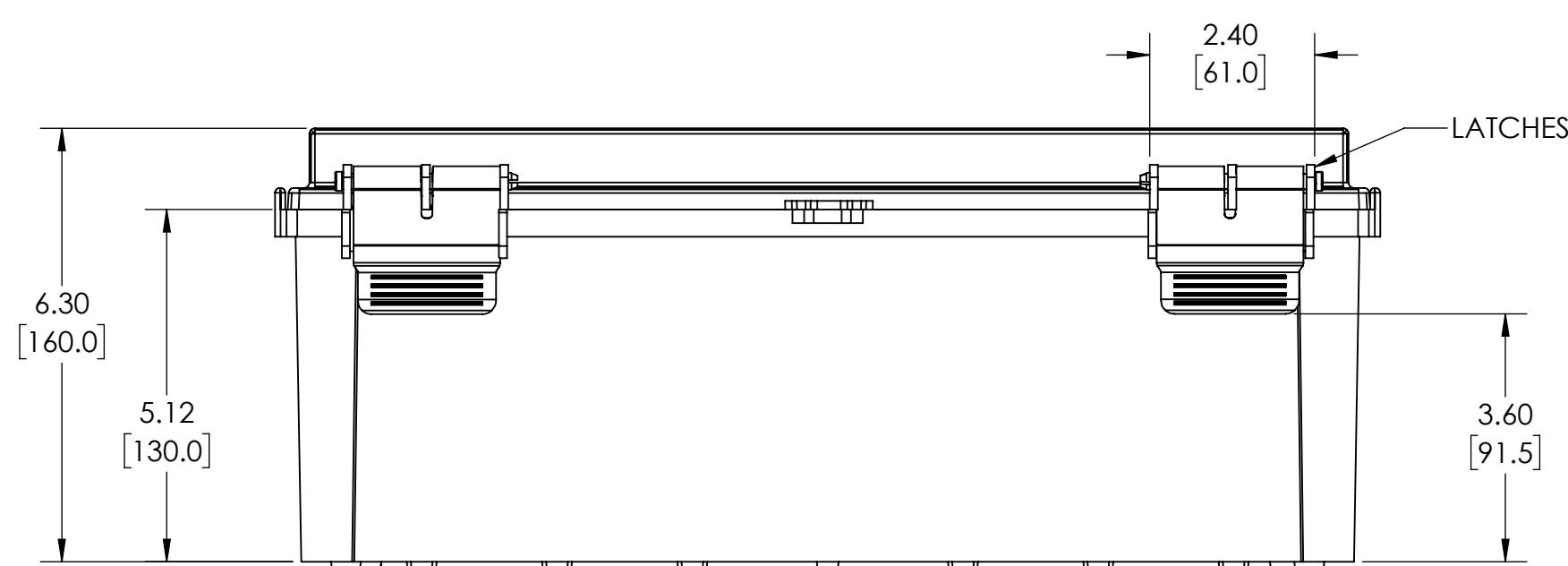
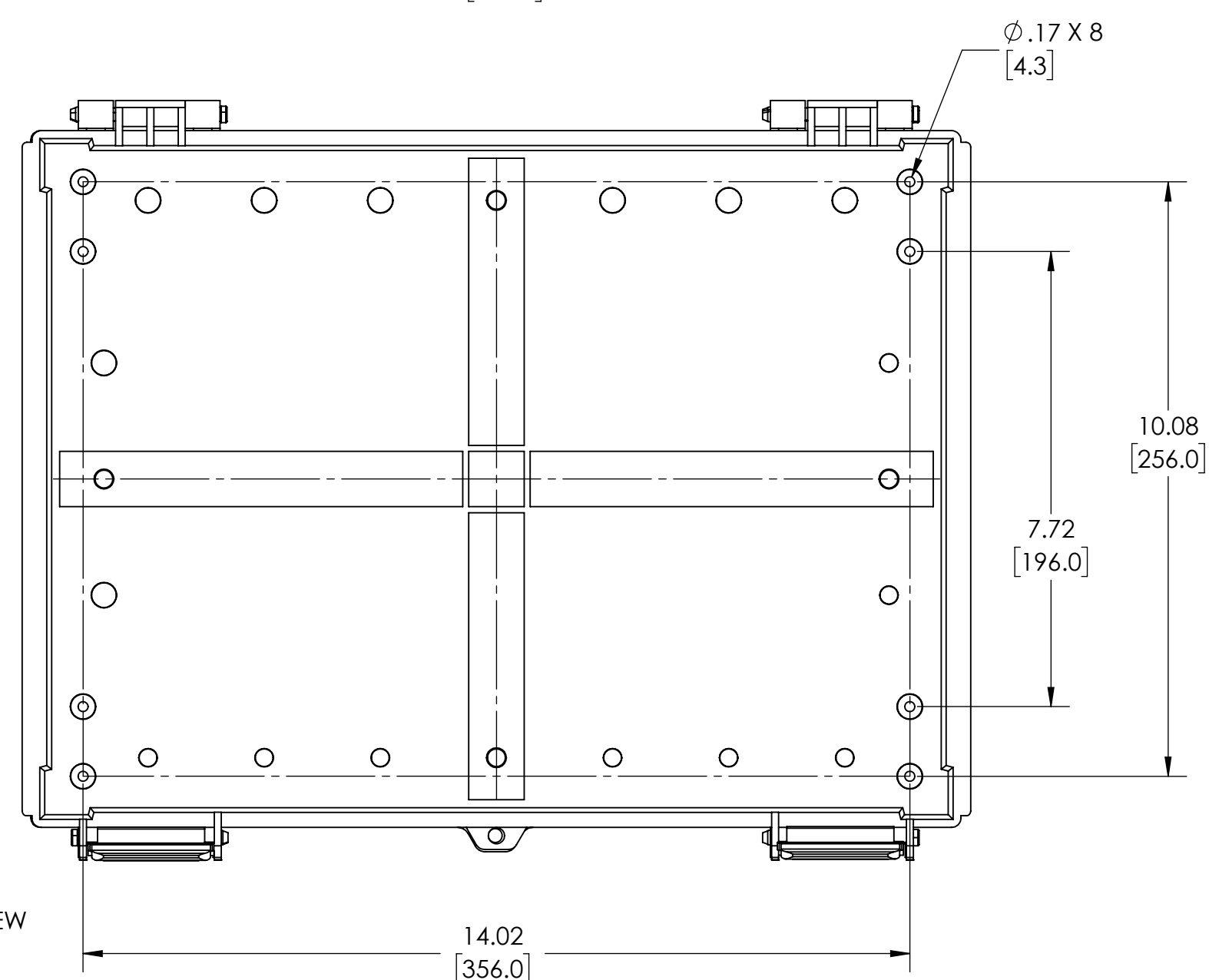
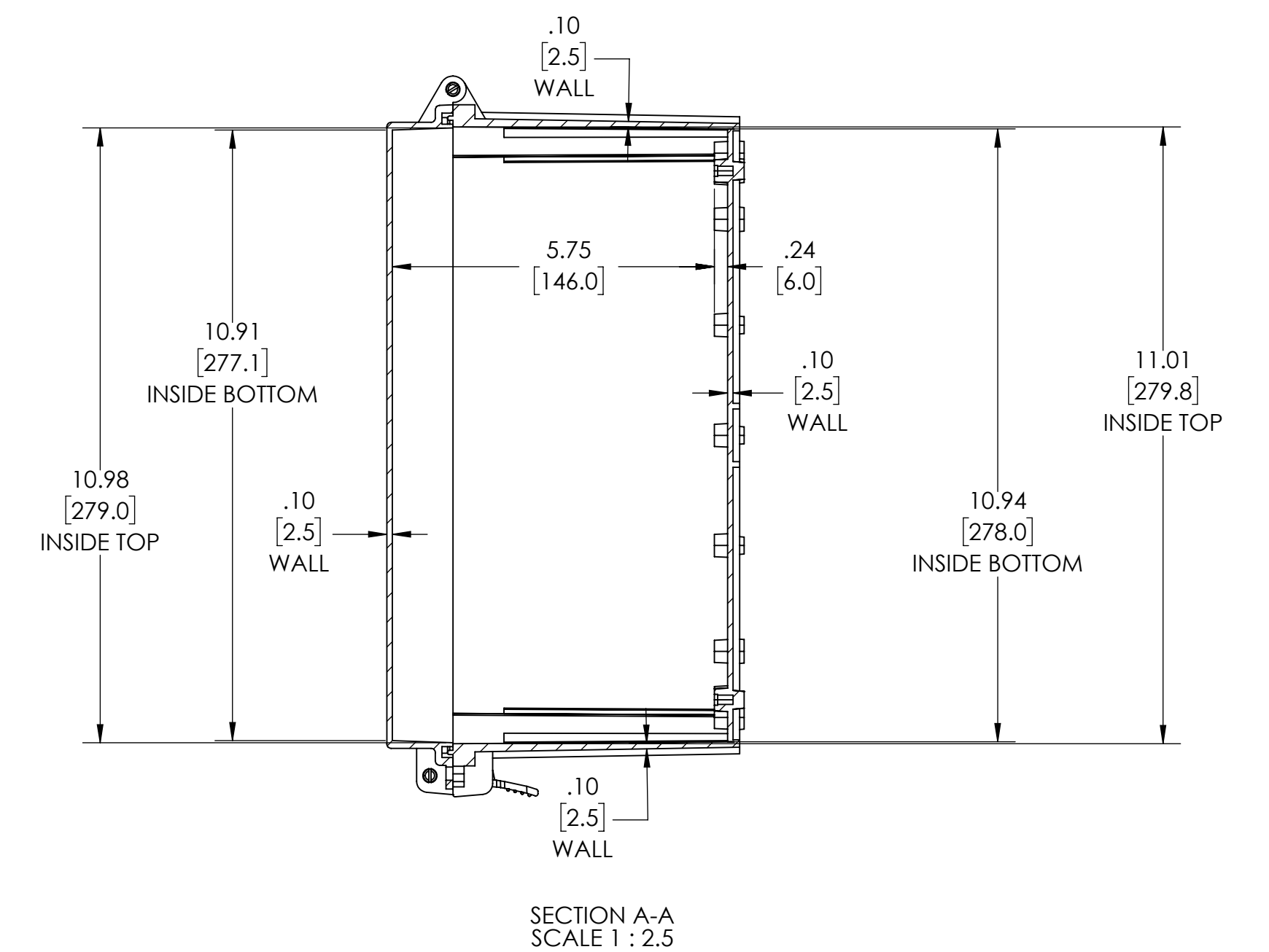
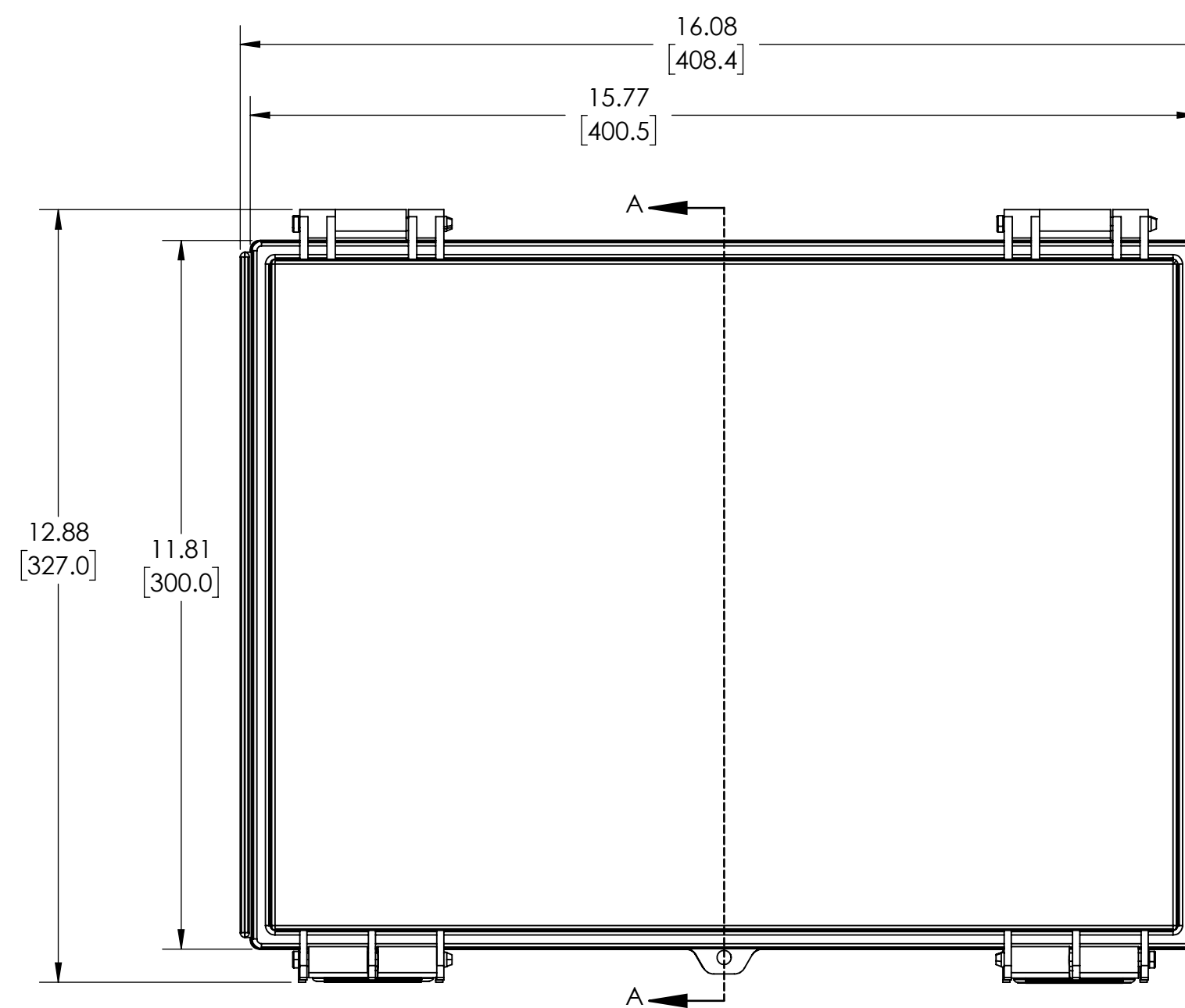
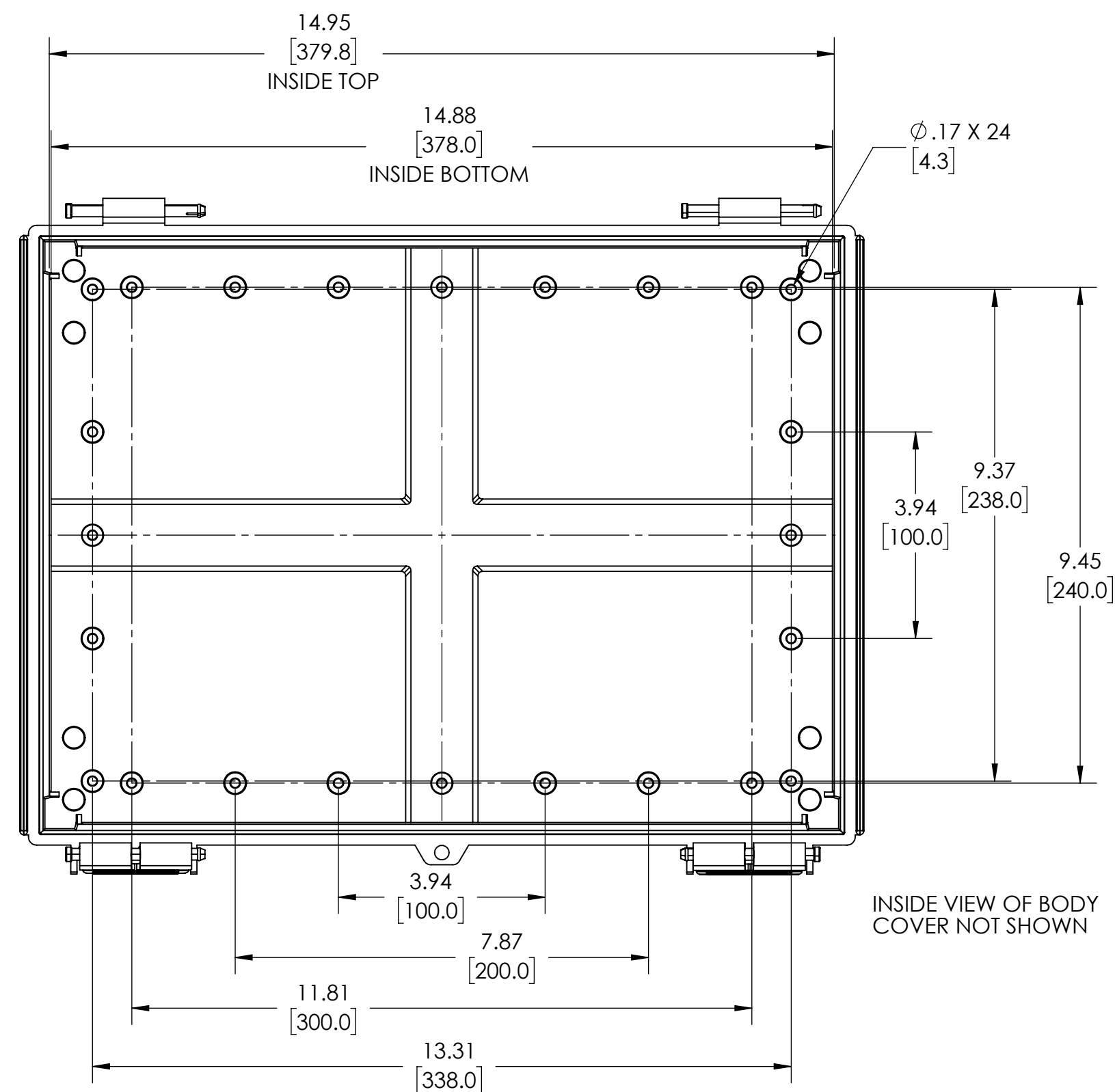
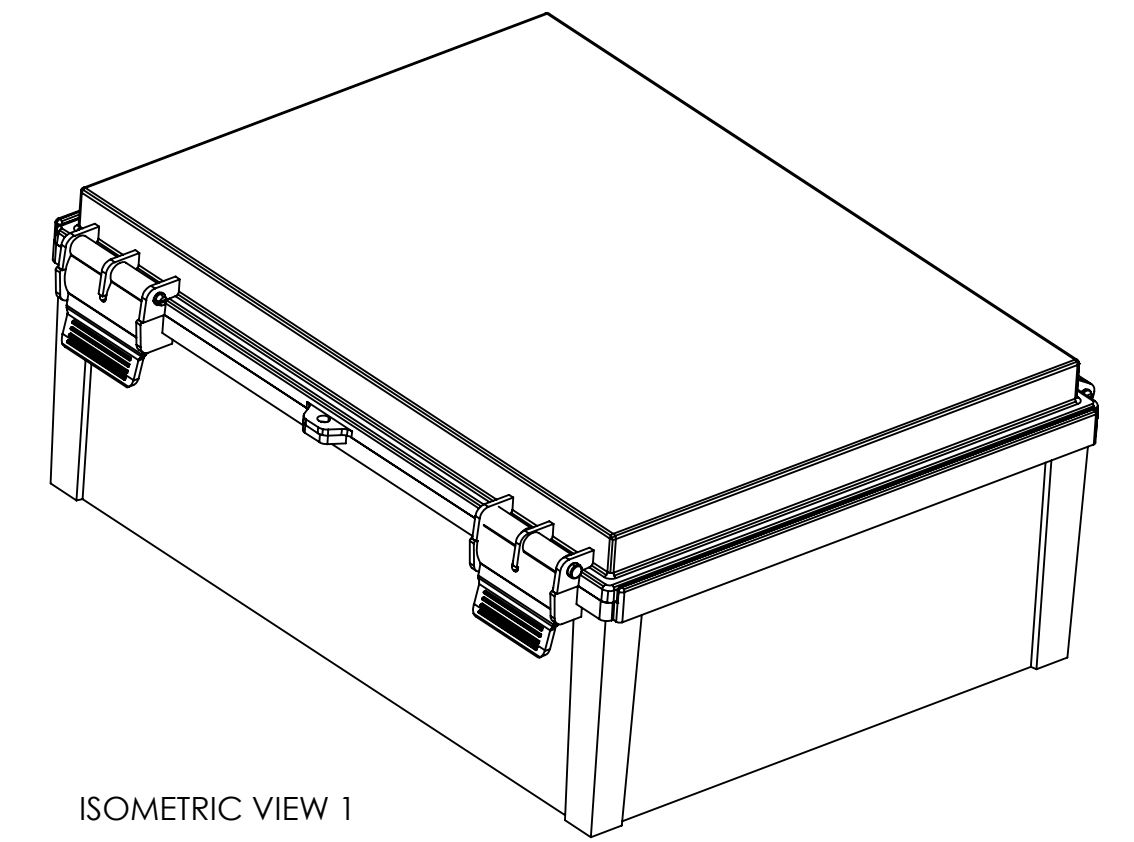
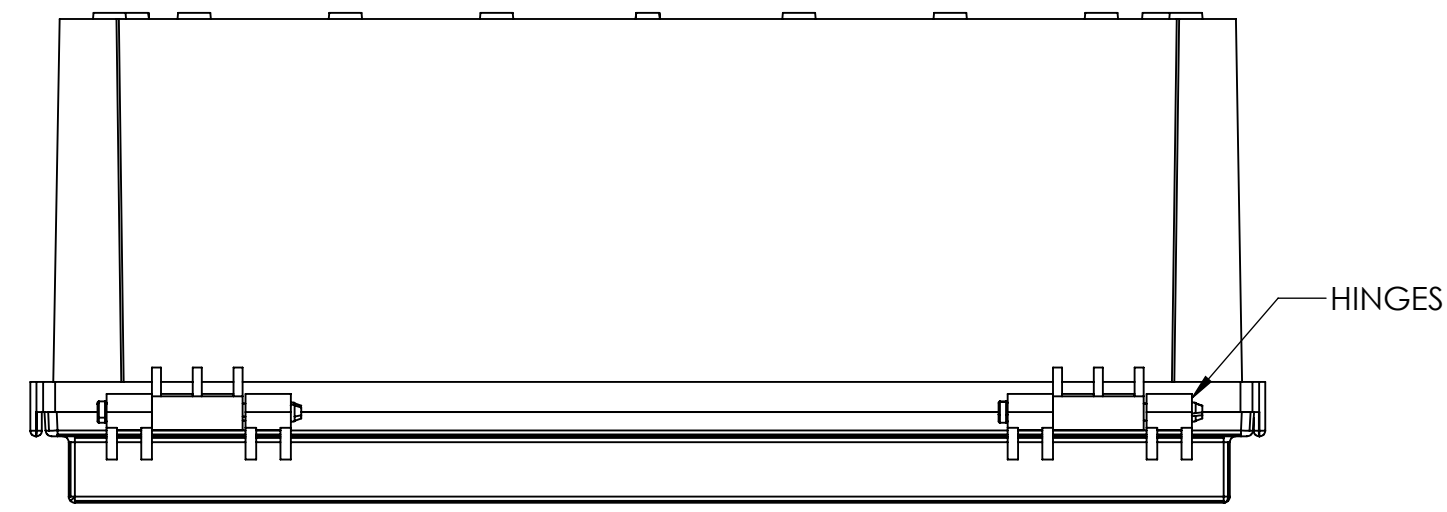

DRAWING FOR REFERENCE  
 WE RESERVE THE RIGHT TO MAKE CHANGES TO OUR  
 STANDARD PRODUCTS. PLEASE CONSULT WITH BUD INDUSTRIES  
 PRIOR TO USING THIS DRAWING FOR DESIGN PURPOSES.