

1. CHARACTERISTICS AND SPECIFICATIONS

ABSOLUTE MAXIMUM RATINGS

Parameter	Symbol	Min	Max	Units
SUPPLY VOLTAGE, +V _{CC} to GND			50	V
OUTPUT CURRENT, peak within SOA			200	mA
POWER DISSIPATION, internal, DC, Amplifier			14.2	W
OUTPUT POWER, SMPS			67	W
INPUT VOLTAGE, Differential		-16	16	V
INPUT VOLTAGE, Common Mode		-16	16	V
TEMPERATURE, pin solder, 10s			225	°C
TEMPERATURE, junction (Note 2)			150	°C
TEMPERATURE RANGE, storage		-40	105	°C
OPERATING TEMPERATURE, case		-40	85	°C

SPECIFICATIONS

Parameter	Test Conditions	Min	Typ	Max	Units
AMPLIFIER INPUT					
OFFSET VOLTAGE			8	40	mV
OFFSET VOLTAGE vs. temperature	0 to 85°C (Case)		-63		μV/°C
OFFSET VOLTAGE vs. supply				32	μV/V
BIAS CURRENT, initial (Note 3)			8.5	200	pA
OFFSET CURRENT, initial			12	400	pA
INPUT RESISTANCE, DC			10 ⁶		Ω
COMMON MODE VOLTAGE RANGE, pos.			+V _S - 2		V
COMMON MODE VOLTAGE RANGE, neg.			-V _S + 5.5		V
COMMON MODE REJECTION, DC		90	118		dB
NOISE	700KHz bandwidth		418		μV RMS
AMPLIFIER GAIN					
OPEN LOOP @ 15 Hz		89	120		dB
GAIN BANDWIDTH PRODUCT @ 1 MHz			1		MHz
PHASE MARGIN	Full temperature range		50		°
AMPLIFIER OUTPUT					
VOLTAGE SWING	I _O = 10 mA		V _S - 2		V
VOLTAGE SWING	I _O = 100 mA		V _S - 8.6	V _S - 12	V
VOLTAGE SWING	I _O = 150 mA		V _S - 10		V
CURRENT, continuous, DC		150			mA
SLEW RATE		100	350		V/μS
SETTLING TIME, to 0.1%	2 V Step		1		μS
RESISTANCE, No load	R _{LIM} = 6.2 Ω		44		Ω
POWER BANDWIDTH, 300 V _{P-P}	+V _S = 160 V, -V _S = -160 V		200		kHz
CURRENT, quiescent, amplifier only		0.2	0.7	2.5	mA

SPECIFICATIONS, (cont).

Parameter	Test Conditions	Min	Typ	Max	Units
SMPS					
INPUT VOLTAGE, V_{IN}		10		50	V
SMPS OUTPUT VOLTAGE, V_B		46.75		365	V
SMPS OUTPUT CURRENT, I_S	$V_B = 10x V_{IN}$	150			mA
OUTPUT VOLTAGE TOLERANCE	$V_B \leq 10x V_{IN}$, $I_S \leq 150$ mA, $R_{SET} = 1\%$		+/-2	6.5	%
VOLTAGE BOOST			10		x input V
THERMAL					
RESISTANCE, DC, junction to case	Full temperature range, $f < 60$ Hz		7.7	8.8	°C/W
RESISTANCE, junction to air	Full temperature range		46		°C/W
TEMPERATURE RANGE, case		0		70	°C

NOTES:

1. (All Min/Max characteristics and specifications are guaranteed over the Specified Operating Conditions. Typical performance characteristics and specifications are derived from measurements taken at typical supply voltages and $T_C = 25^\circ\text{C}$).
2. Long term operation at the maximum junction temperature will result in reduced product life. Derate power dissipation to achieve high MTTF.
3. Doubles for every 10°C of temperature increase.
4. $+V_S$ and $-V_S$ denote the positive and negative supply voltages to the output stage.

PIN DESCRIPTIONS

Pin #	Pin name	Description
21 - 23, 25	V_{IN}	Input voltage pins for the on board high voltage switch mode power supply.
24	V_{BIAS}	Input voltage pin for the boost controller circuitry. This pin is typically tied to V_{IN}
12 - 15	Q2D	Drain node of the SMPS MOSFET switch. An external RC snubber may be connect from this node to power ground to reduce or eliminate overshoot and ringing at switch turn off, reducing switching noise on the SMPS.
8	V_B	This is the output of the high voltage SMPS and typically is tied to pin 6, L_{FIN} . Other loads can be added to this pin as long as the maximum output power of the SMPS is not exceeded. For proper operation, an external high voltage, low ESR capacitor must be connected to this pin. Refer to the paragraph titled "SMPS Output Capacitor".
6	L_{FIN}	The high voltage SMPS, V_B , is connected to this pin to power the MP400FC amplifier through a 47 μH filter inductor. The supply current in to this pin can not exceed 200 mA.
4	$+V_S$	MP400FC amplifier high voltage supply pin. This pin is used for external supply bypass. A high quality ceramic capacitor of at least 1uF should be used. The high voltage SMPS, V_B , can be connected directly to this pin, bypassing the 47 μH filter inductor.
34	R_{SET}	SMPS voltage set resistor. A resistor is connected from this pin to power ground to set the SMPS voltage.
26 - 33	PGND	Power ground. SMPS switching circuits are referenced to ground through these pins.
35	AGND	Analog ground for MP400FC amplifier circuits. AGND and PGND are connected at one point on the MP400FC. Avoid external connections between AGND and PGND.
41	$-V_S$	This pin is typically connected to AGND. However, an external negative supply voltage can be connected to this pin.
39	+IN	Amplifier non-inverting input
40	-IN	Amplifier inverting input
1	V_{OUT}	Amplifier output
2	I_{LIM}	Amplifier current limit. A current limit resistor must be connected between I_{LIM} and V_{OUT} . $R_{LIM} = 0.7/I_{LIM}$.

PIN DESCRIPTIONS (CONT.)

36	C _{R+}	+ side compensation capacitor connection one.
37	C _{C+}	+ side compensation capacitor connection two.
38	C _{R-}	- side compensation capacitor connection one.
42	C _{C-}	- side compensation capacitor connection two.

Unused pins should be left open. This is mandatory for pins 3, 5, 7, 9, 11 and 16.

TYPICAL PERFORMANCE GRAPHS

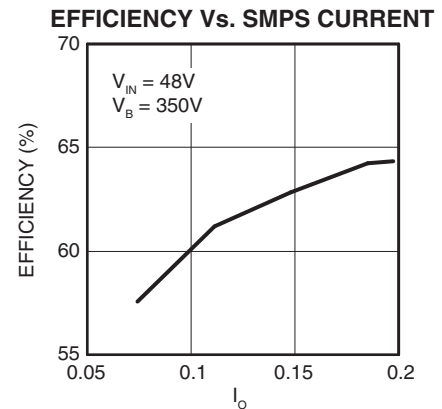
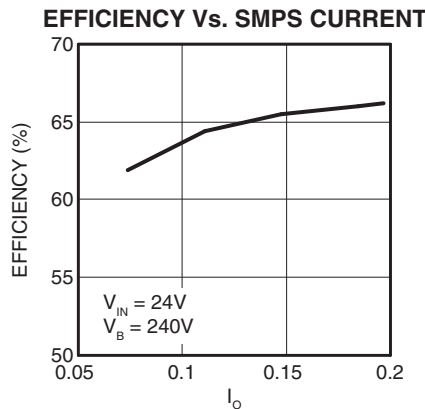
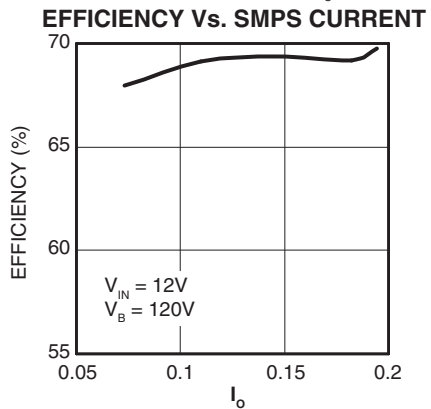
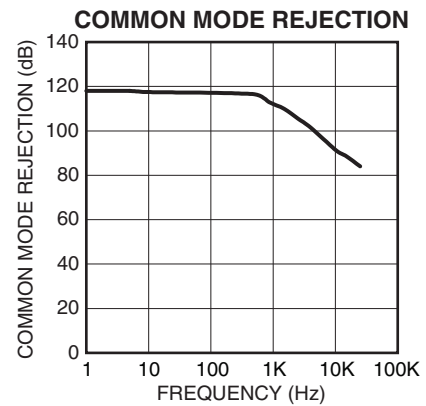
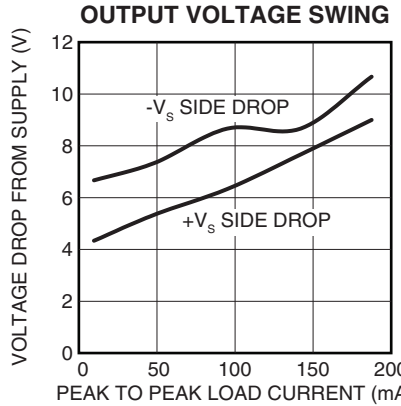
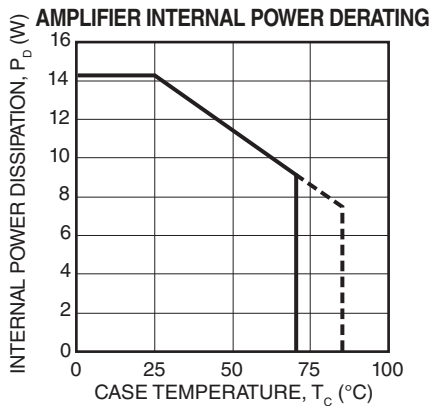
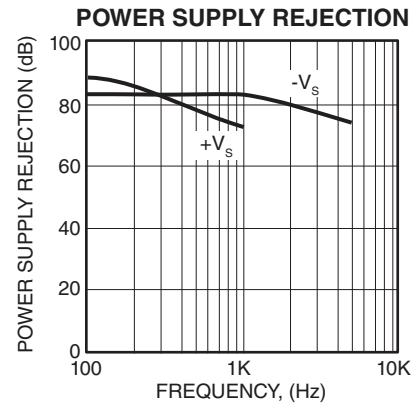
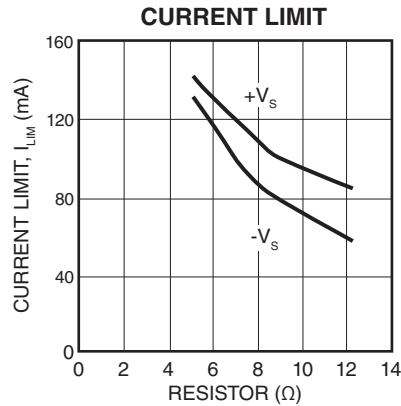
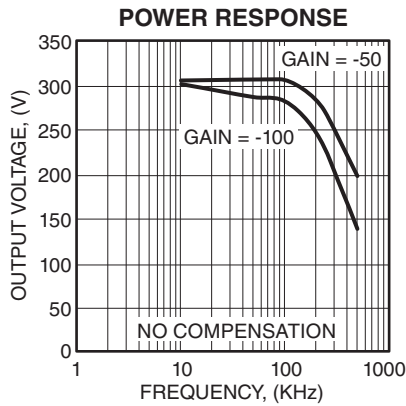

TYPICAL PERFORMANCE GRAPHS (CONT.)

SMPS CURRENT VS. SMPS VOLTAGE

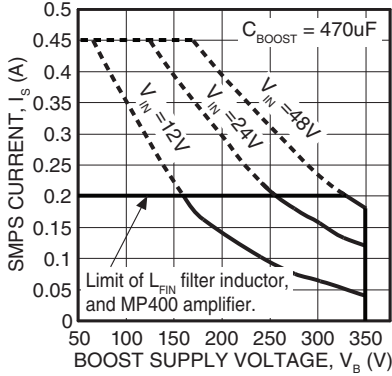

SMPS POWER DERATING

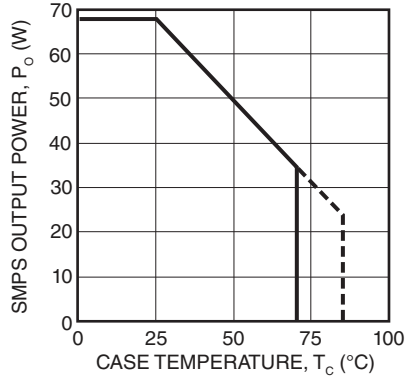

PULSE RESPONSE vs. CAP LOAD

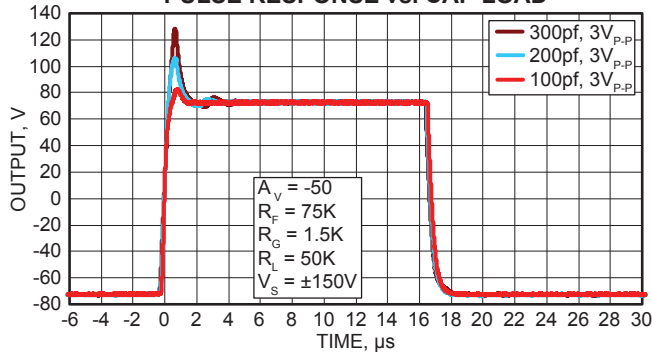

PULSE RESPONSE vs. CAP LOAD

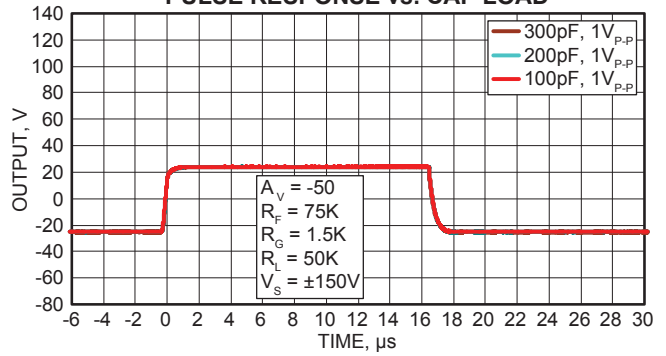

PULSE RESPONSE vs. CAP LOAD

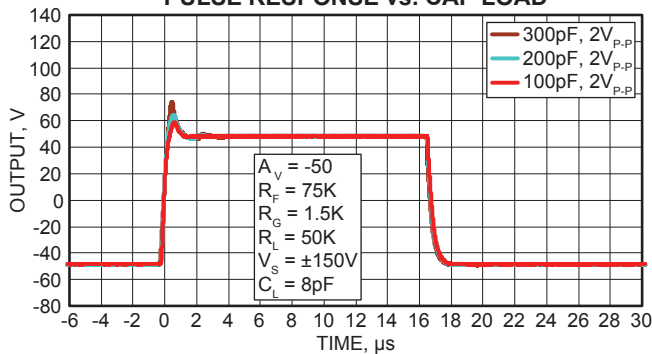

SMALL SIGNAL OPEN LOOP GAIN

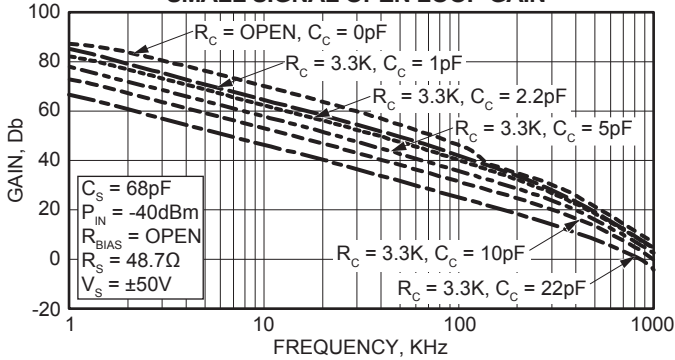

SMALL SIGNAL OPEN LOOP PHASE, $V_O = 250\text{mV}_{P-P}$

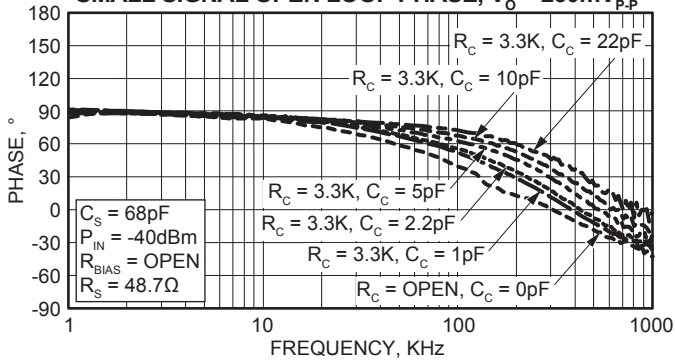

SMALL SIGNAL OPEN LOOP PHASE

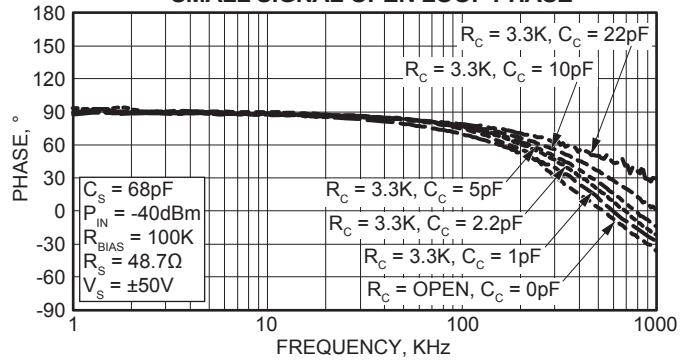

GAIN vs. INPUT/OUTPUT SIGNAL LEVEL

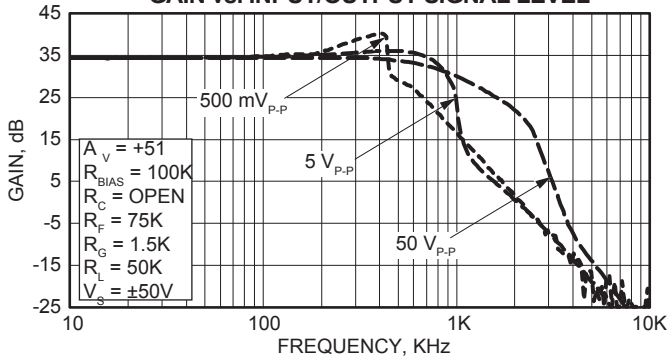

SMALL SIGNAL GAIN vs. COMPENSATION, $V_O = 5\text{V}_{P-P}$

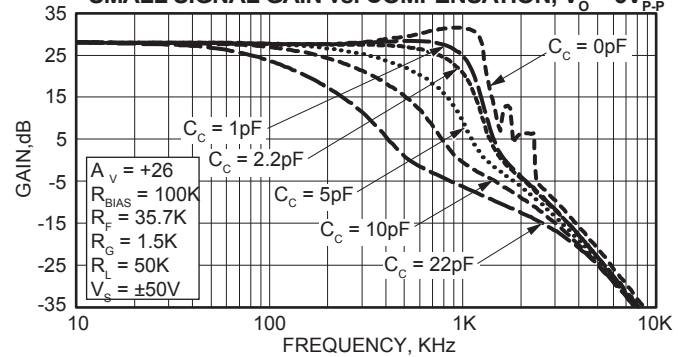

SMALL SIGNAL GAIN vs. COMPENSATION, $V_O = 500\text{mV}_{P-P}$

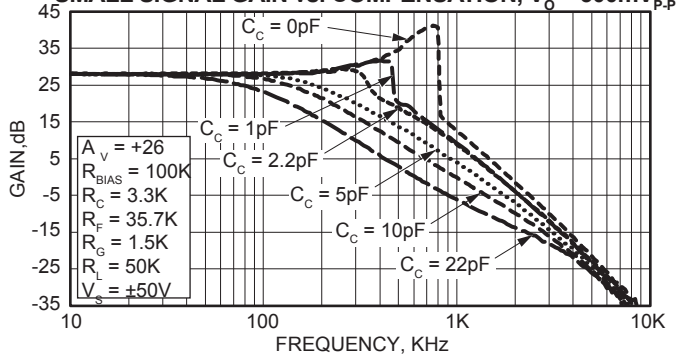

LARGE SIGNAL GAIN vs. COMPENSATION, $V_O = 50\text{V}_{P-P}$

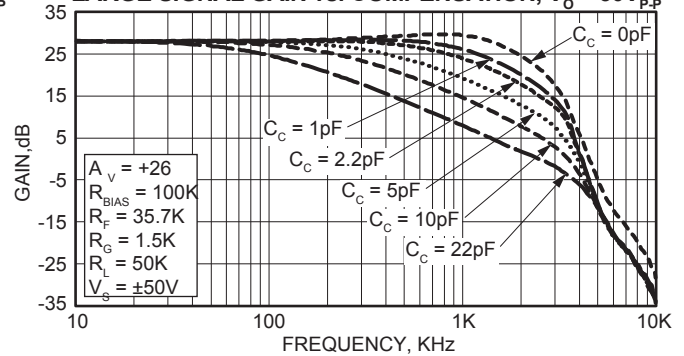

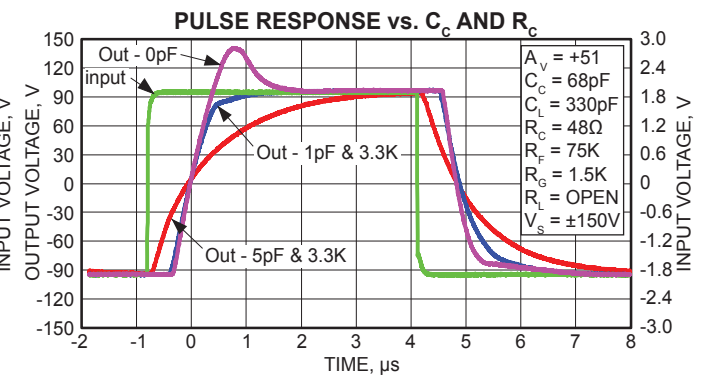
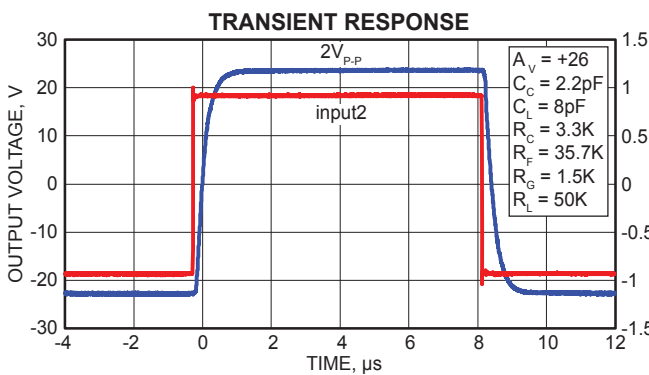
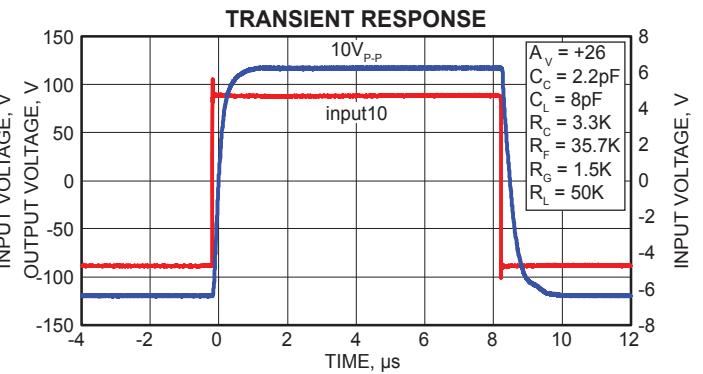
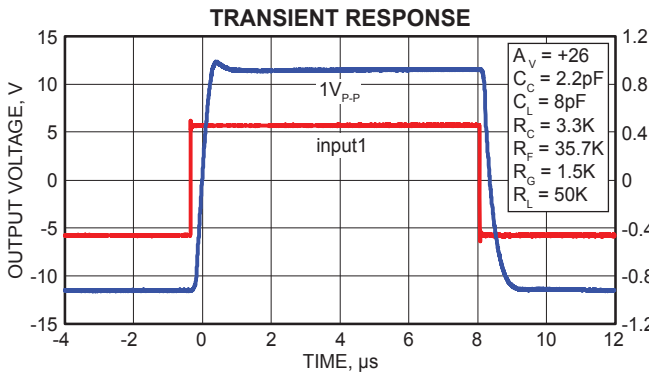
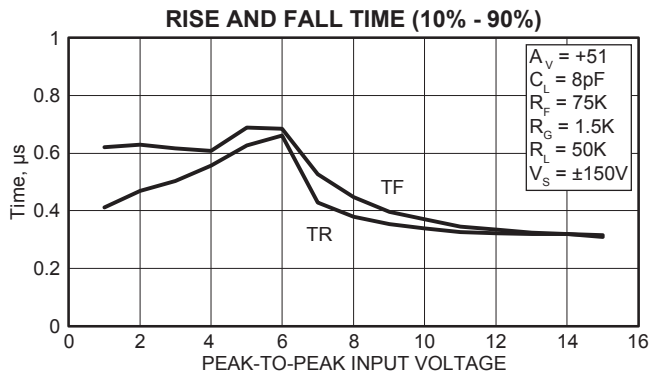
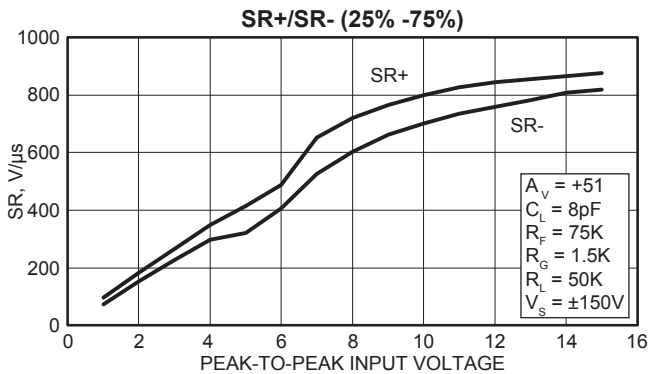
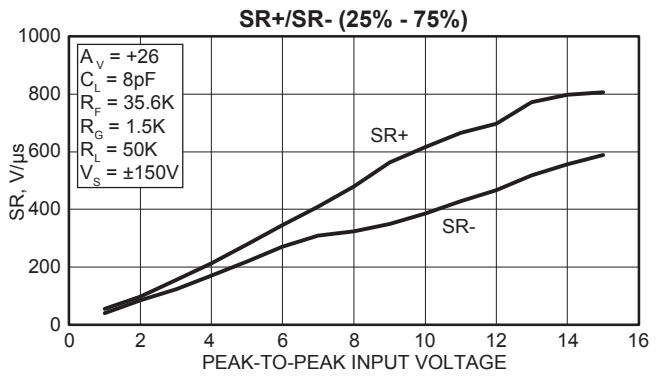
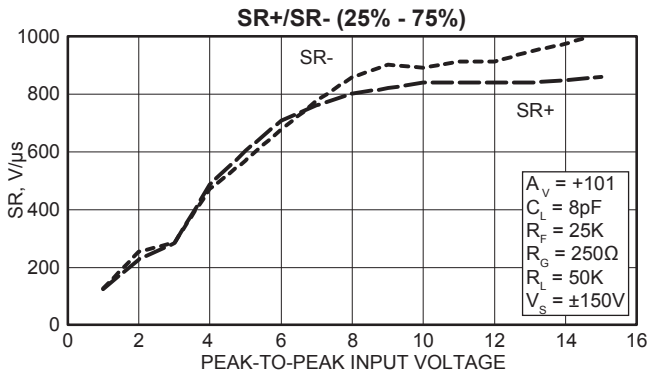

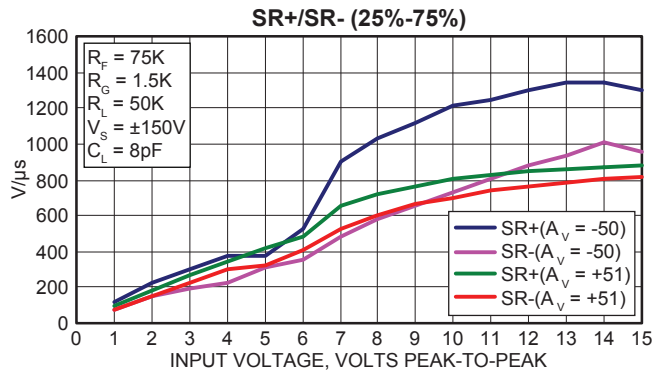
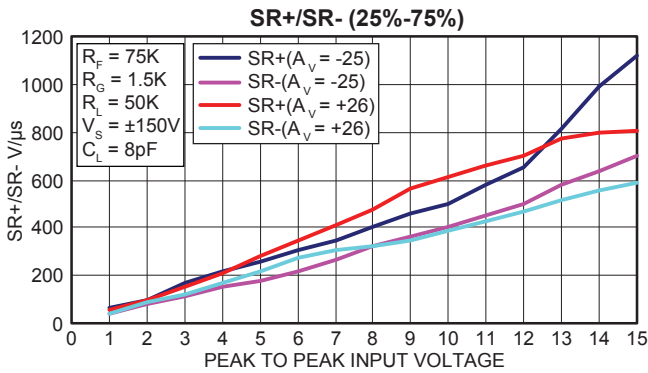
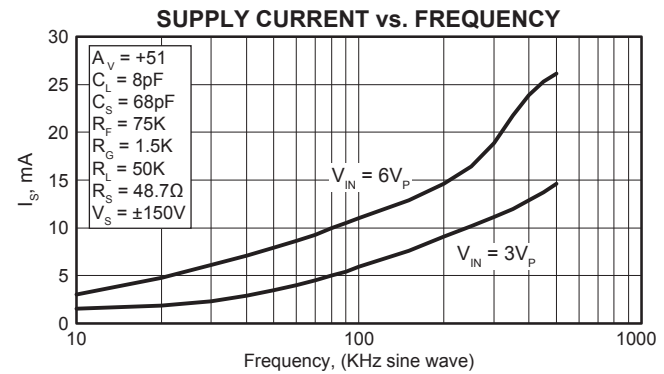
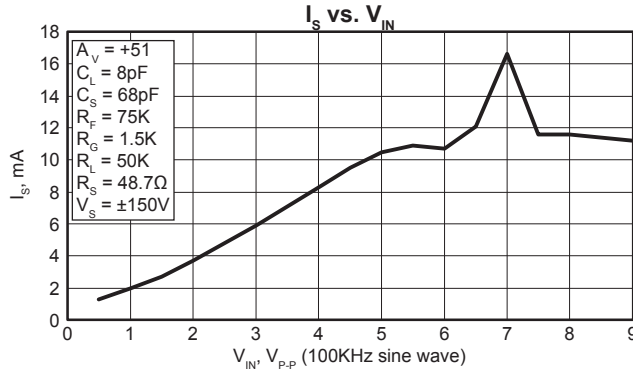
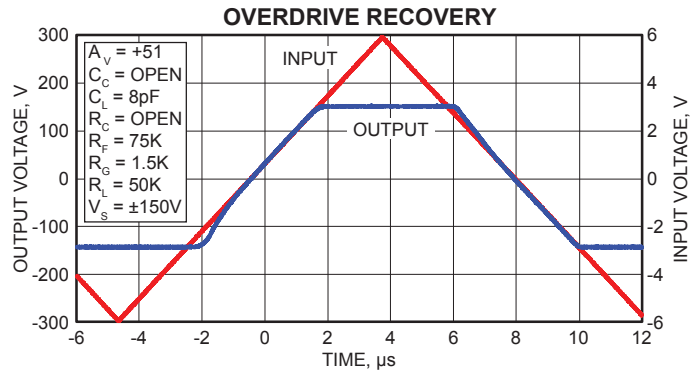
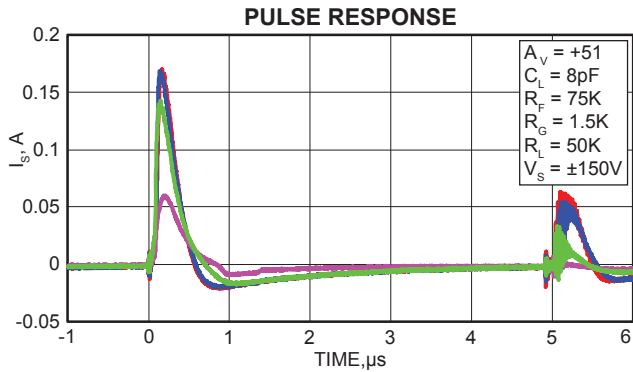

EXTERNAL CONNECTIONS

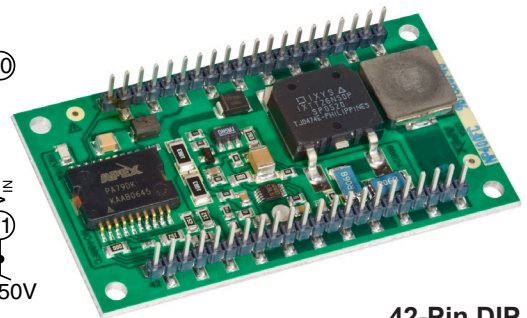
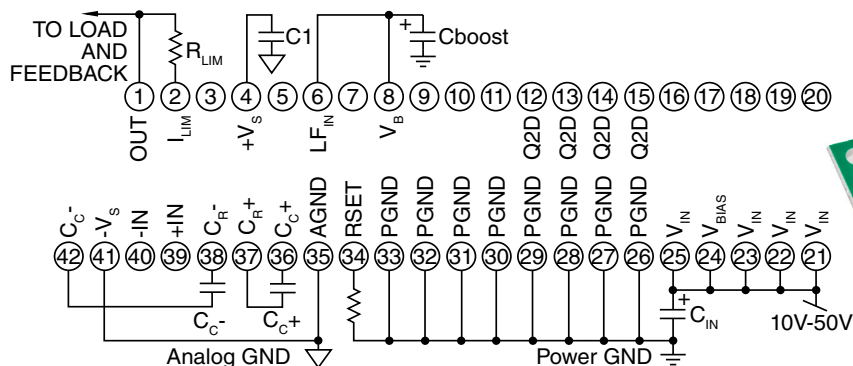

**42-Pin DIP
Package Style FC**

TYPICAL APPLICATION

The MP400FC is ideally suited to driving both piezo actuation and deflection applications off of a single low voltage supply. The circuit above boosts a system 24 V buss to 350 V to drive an ink jet print head. The MP400FC's high speed deflection amplifier is biased for single supply operation by external resistors R2 – R6, so that a 0 to 5 V DAC can be used as the input to the amplifier to drive the print head from 0 to >300 V.

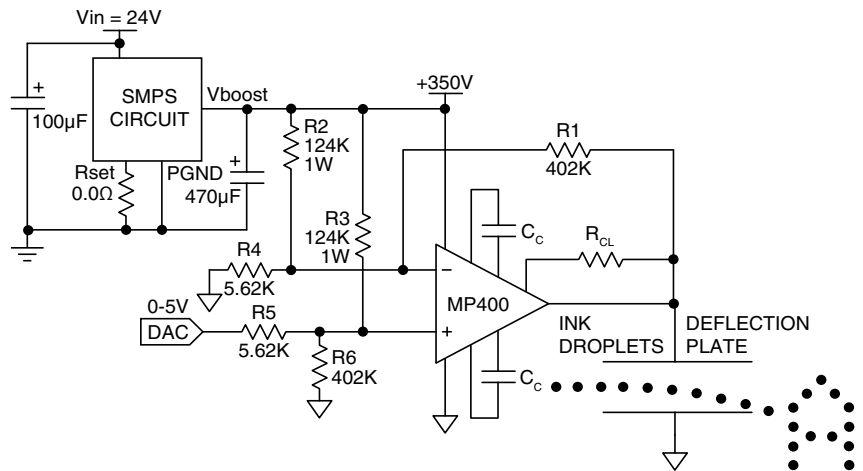

GENERAL

Please read Application note 1 “General operating considerations” which covers stability, power supplies, heat sinking, mounting, current limit, SOA interpretation, and specification interpretation. Visit www.apexanalog.com for design tools that help automate tasks such as calculations for stability, internal power dissipation, and current limit. There you will also find a complete application notes library, technical seminar workbook, and evaluation kits.

THEORY OF OPERATION

The PA78 is designed specifically as a high speed pulse amplifier. In order to achieve high slew rates with low idle current, the internal design is quite different from traditional voltage feedback amplifiers. Basic op amp behaviors like high input impedance and high open loop gain still apply. But there are some notable differences, such as signal dependent supply current, bandwidth and output impedance, among others. The impact of these differences varies depending on application performance requirements and circumstances. These different behaviors are ideal for some applications but can make designs more challenging in other circumstances.

SUPPLY CURRENT AND BYPASS CAPACITANCE

A traditional voltage feedback amplifier relies on fixed current sources in each stage to drive the parasitic capacitances of the next stage. These currents combine to define the idle or quiescent current of the amplifier. By design, these fixed currents are often the limiting parameter for slew rate and bandwidth of the amplifier. Amplifiers which are high voltage and have fast slew rates typically have high idle currents and dissipate notable power with no signal applied to the load. At the heart of the PA78 design is a signal dependent current source which strikes a new balance between supply current and dynamic performance. With small input signals, the supply current of the PA78 is very low, idling at less than 1 mA. With large transient input signals, the supply currents increase dramatically to allow the amplifier stages to respond quickly. The Pulse Response plot in the typical performance section of this datasheet describes the dynamic nature of the supply current with various input transients.

Choosing proper bypass capacitance requires careful consideration of the dynamic supply currents. High frequency ceramic capacitors of 0.1 µF or more should be placed as close as possible to the amplifier supply pins. The inductance of the routing from the supply pins to these ceramic capacitors will limit the supply of peak current during transients, thus reducing the slew rate of the PA78. The high frequency capacitance should be supplemented by additional bypass capacitance not more than a few centimeters from the amplifier. This additional bypass can be a slower capacitor technology, such as electrolytic, and is necessary to keep the supplies stable during sustained output currents. Generally, a few microfarad is sufficient.

SMALL SIGNAL PERFORMANCE

The small signal performance plots in the typical performance section of this datasheet describe the behavior when the dynamic current sources described previously are near the idle state. The selection of compensation capacitor directly affects the open loop gain and phase performance.

Depending on the configuration of the amplifier, these plots show that the phase margin can diminish to very low

levels when left uncompensated. This is due to the amount of bias current in the input stage when the part is in standby. An increase in the idle current in the output stage of the amplifier will improve phase margin for small signals although will increase the overall supply current.

Current can be injected into the output stage by adding a resistor, R_{BIAS} , between C_C- and V_{S+} . The size of R_{BIAS} will depend upon the application but 500 μA (50 V V_{S+} supply/100K) of added bias current shows significant improvement in the small signal phase plots. Adding this resistor has little to no impact on small signal gain or large signal performance as under these conditions the current in the input stage is elevated over its idle value. It should also be noted that connecting a resistor to the upper supply only injects a fixed current and if the upper supply is fixed and well bypassed. If the application includes variable or adjustable supplies, a current source diode could also be used. These two terminal components combine a JFET and resistor connected within the package to behave like a current source.

As a second stability measure, the PA78 is externally compensated and performance can be optimized to the application. Unlike the R_{BIAS} technique, external phase compensation maintains the low idle current but does affect the large signal response of the amplifier. Refer to the small and large signal response plots as a guide in making the tradeoffs between bandwidth and stability. Due to the unique design of the PA78, two symmetric compensation networks are required. The compensation capacitor C_C must be rated for a working voltage of the full operating supply voltage ($+V_S$ to $-V_S$). NPO capacitors are recommended to maintain the desired level of compensation over temperature.

The PA78 requires an external 33 pF capacitor between C_C- and $-V_S$ to prevent oscillations in the falling edge of the output. This capacitor should be rated for the full supply voltage ($+V_S$ to $-V_S$).

LARGE SIGNAL PERFORMANCE

As the amplitude of the input signal increases, the internal dynamic current sources increase the operation bandwidth of the amplifier. This unique performance is apparent in its slew rate, pulse response, and large signal performance plots. Recall the previous discussion about the relationships between signal amplitude, supply current, and slew rate. As the amplitude of the input amplitude increases from 1 V_{P-P} to 15 V_{P-P} , the slew rate increases from 50 $V/\mu s$ to well over 350 $V/\mu s$.

Notice the knee in the Rise and Fall times plot, at approximately 6 V_{P-P} input voltage. Beyond this point the output becomes clipped by the supply rails and the amplifier is no longer operating in a closed loop fashion. The rise and fall times become faster as the dynamic current sources are providing maximum current for slewing. The result of this amplifier architecture is that it slews fast, but allows good control of overshoot for large input signals. This can be seen clearly in the large signal Transient Response plots.

HEATSINKING AND SAFE OPERATING AREA

The MOSFET output stage of the PA78 is not limited by second breakdown considerations as in bipolar output stages. Only thermal considerations of the package and current handling capabilities limit the Safe Operating Area. The SOA plots include power dissipation limitations which are dependent upon case temperature. Keep in mind that the dynamic current sources which drive high slew rates can increase the operating temperature of the amplifier during periods of repeated slewing. The plot of supply current vs. input signal amplitude for a 100 kHz signal provides an indication of the supply current with repeated slewing conditions. This application dependent condition must be considered carefully.

The output stage is self-protected against transient flyback by the parasitic body diodes of the output stage. However, for protection against sustained high energy flyback, external, fast recovery diodes must be used.

CURRENT LIMIT

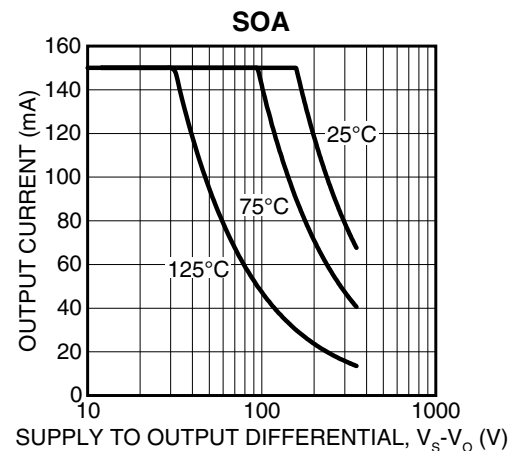

For proper operation, the current limit resistor, R_{LIM} , must be connected as shown in the external connections diagram. For maximum reliability and protection, the largest resistor value should be used. The maximum practical value for R_{LIM} is about 12 Ω . However, refer to the SOA curves for each package type to assist in selecting the optimum value for R_{LIM} in the intended application. Current limit may not protect against short circuit conditions with supply voltages over 200 V.

LAYOUT CONSIDERATIONS

The PA78 is built on a dielectrically isolated process and the package tab is therefore not electrically connected to the amplifier. For high speed operation, the package tab should be connected to a stable reference to reduce capacitive coupling between amplifier nodes and the floating tab. It is often convenient to directly connect the tab to GND or one of the supply rails, but an AC connection through a 1 μ F capacitor to GND is also sufficient if a DC connection is undesirable.

Care should be taken to position the R_C / C_C compensation networks close to the amplifier compensation pins. Long loops in these paths pick up noise and increase the likelihood of LC interactions and oscillations.

SMPS OPERATION

The MP400FC is designed to operate off of a standard voltage rail. Typical values include 12 V, 24 V, or 48 V. The addition of the on-board SMPS eliminates the need to design or purchase a high voltage power supply. The only inputs required by the SMPS are the V_{IN} source. Input and output filter capacitor, and boost voltage set resistor (R_{SET}).

$$R_{SET} = \frac{1.85 \cdot 10^5}{V_{BOOST} - 49.95} - 615$$

The SMPS output can be adjusted between a minimum of 50 V to a maximum of 350 V. The voltage boost adjustment is independent of V_{IN} . Adjustment to the boost level is made through a resistor from the R_{SET} pin to ground. The resistor value is:

Where V_{BOOST} = desired SMPS voltage.

- Example: 1) Desired $V_{BOOST} = 160$ V
2) $R_{SET} = 1K$ (1066 by equation)

If R_{SET} is open, V_{BOOST} will be 50 V. If R_{SET} is shorted to ground V_{BOOST} will be limited to 350 V.

Note that while the MP400 SMPS generates a positive voltage from 50 V to 350 V, the amplifier may operate from a variety of supply voltages. Symmetric, asymmetrical and single supply configurations can be used so long as the total supply voltage from $+V_s$ to $-V_s$ does not exceed 350 V. The amplifier performance graphs in this datasheet include some plots taken with symmetrical supplies, but those plots generally apply to all supply configurations.

SMPS OUTPUT CAPACITOR

An external SMPS output filter capacitor is required for proper operation. ESR considerations prevail in the choice of the output filter capacitor. Select the highest value capacitor that meets the following ESR requirement. The minimum value for C_{BOOST} is 100 μ F.

$$ESR = dVo / I_{LPK}$$

Where,

dVo = The maximum acceptable output ripple voltage

I_{LPK} = Peak inductor current = $(1/L) \cdot V_{IN} \cdot ton$

L = 10^{-6} if the internal inductor is used.

V_{IN} = Input voltage of the application.

ton = $\sqrt{(2 \cdot Io \cdot L \cdot ((Vo + 0.6 - V_{IN}) / (F_{SW} \cdot V_{IN}^2)))}$

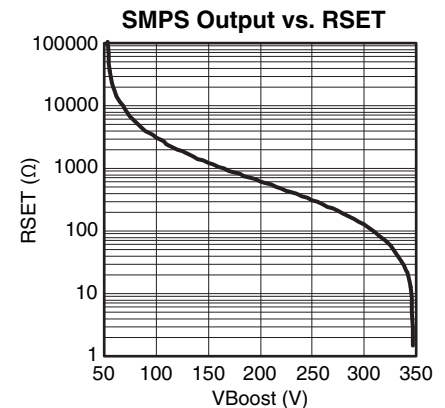

V_{BOOST} = The boost supply voltage of the application.
 I_{O} = The maximum continuous output current for the application.
 F_{SW} = 100 KHz switching frequency of the MP400FC boost supply.

SMPS INPUT CAPACITOR

An external input capacitor is required. This capacitor should be at least 100 μF .

THERMAL CONSIDERATIONS

For reliable operation the MP400FC will require a heatsink for most applications. When choosing the heatsink the power dissipation in the op amp and the SMPS MOSFET switch (Q2) are both considered. The power dissipation of the op amp is determined in the same manner as any power op amp. The power dissipation of the MOSFET switch (Q2) is the sum of the power dissipation due to conduction and the switching power.

$$P_{\text{D(Q2)}} = (I_{\text{IN(pk)}}^2 \cdot R_{\text{DS(ON)}} \cdot D) + (I_{\text{IN(pk)}} \cdot V_{\text{IN}} \cdot t_{\text{r}} \cdot F_{\text{SW}})$$

Where:

V_{IN} = SMPS input voltage
 V_{B} = SMPS output voltage
 I_{O} = Total SMPS output current
 F_{SW} = 100 KHz
 $R_{\text{DS(ON)}}$ = 0.621 Ω
 t_{r} = 82 x 10⁻⁹s
 D = $t_1 \cdot F_{\text{SW}}$

$$t_1 = \sqrt{2 \cdot I_{\text{O}} \cdot 10 \times 10^{-6} \cdot \left(\frac{V_{\text{B}} - V_{\text{IN}}}{F_{\text{SW}} \cdot V_{\text{IN}}^2} \right)}$$

$$I_{\text{IN(pk)}} = \frac{V_{\text{B}} \cdot t_{\text{d}}}{10 \times 10^{-6}}$$

$$t_{\text{d}} = t_1 \cdot \left(\frac{V_{\text{B}}}{V_{\text{B}} - V_{\text{IN}}} \right) - t_1$$

NEED TECHNICAL HELP? CONTACT APEX SUPPORT!

For all Apex Microtechnology product questions and inquiries, call toll free 800-546-2739 in North America.

For inquiries via email, please contact apex.support@apexanalog.com.

International customers can also request support by contacting their local Apex Microtechnology Sales Representative.

To find the one nearest to you, go to www.apexanalog.com

IMPORTANT NOTICE

Apex Microtechnology, Inc. has made every effort to insure the accuracy of the content contained in this document. However, the information is subject to change without notice and is provided "AS IS" without warranty of any kind (expressed or implied). Apex Microtechnology reserves the right to make changes without further notice to any specifications or products mentioned herein to improve reliability. This document is the property of Apex Microtechnology and by furnishing this information, Apex Microtechnology grants no license, expressed or implied under any patents, mask work rights, copyrights, trademarks, trade secrets or other intellectual property rights. Apex Microtechnology owns the copyrights associated with the information contained herein and gives consent for copies to be made of the information only for use within your organization with respect to Apex Microtechnology integrated circuits or other products of Apex Microtechnology. This consent does not extend to other copying such as copying for general distribution, advertising or promotional purposes, or for creating any work for resale.

APEX MICROTECHNOLOGY PRODUCTS ARE NOT DESIGNED, AUTHORIZED OR WARRANTED TO BE SUITABLE FOR USE IN PRODUCTS USED FOR LIFE SUPPORT, AUTOMOTIVE SAFETY, SECURITY DEVICES, OR OTHER CRITICAL APPLICATIONS. PRODUCTS IN SUCH APPLICATIONS ARE UNDERSTOOD TO BE FULLY AT THE CUSTOMER OR THE CUSTOMER'S RISK.

Apex Microtechnology, Apex and Apex Precision Power are trademarks of Apex Microtechnology, Inc. All other corporate names noted herein may be trademarks of their respective holders.