

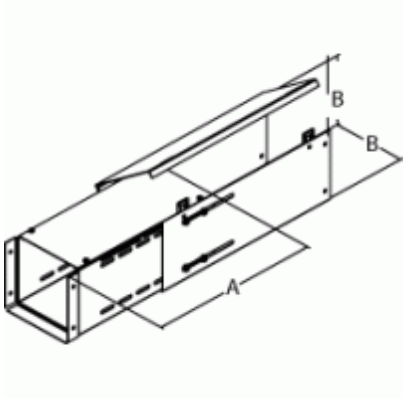

Quality Products. Service Excellence.

Telecope Fitting CWTL Series



Painted Steel

Part No.	For use with
CWTL2	2.5 x 2.5
CWTL4	4 x 4
CWTL6	6 x 6
CWTL8	8 x 8
CWTL10	10 x 10
CWTL12	12 x 12

Unpainted Galvanized

Part No.	For use with
CWTL2G	2.5 x 2.5
CWTL4G	4 x 4
CWTL6G	6 x 6
CWTL8G	8 x 8
CWTL10G	10 x 10
CWTL12G	12 x 12

Data subject to change without notice

© 2021. Hammond Manufacturing Ltd. All rights reserved.