

## LMT78\_1.0R series

Wide input, non-isolated & regulated, single output, SMD package

## Switching Regulator

- ⊕ Efficiency up to 95%
- ⊕ No need for heat sinks
- ⊕ 1.0AMP SMD package
- ⊕ Wide input voltage range (4.75V - 32V)
- ⊕ Adjustable output voltage
- ⊕ Remote ON/OFF control
- ⊕ Short circuit protection (SCP), thermal shutdown
- ⊕ Very low shutdown current
- ⊕ Super low ripple and noise
- ⊕ IEC62368, UL62368, EN62368 approved

The LMT78\_1.0R series with high efficiency switching regulators is an ideally supply for space constrained mobile applications. There is no need for any heat sink, even if operated at + 85°C. The additional features include remote ON/OFF control and adjustable output voltage.

Super low ripple and noise of typically only 10mV and a shutdown input current of typically only 15uA.



UL-62368-1 (E347551)

### Common specifications

Cooling:	Free air convection
Short circuit protection mode:	Hiccup mode
Short circuit protection:	Continuous, automatic recovery
Operating temperature range:	-40°C ~ +85°C
Storage temperature range:	-55°C ~ +125°C
Lead temperature:	300°C MAX, 1.5mm from case for 10 sec
Operating case temperature:	100°C MAX
Reflow Soldering Temperature:	Peak temp. ≤ 245°C, maximum duration time ≤ 60s at 217°C. For actual application, please refer to IPC/JEDEC J-STD-020D.1
Storage humidity range:	< 95%
Case material:	Plastic [UL94-V0]
MTBF (MIL-HDBK-217F, +25°C):	> 2,000,000 hours
Package weight:	1.7g
Dimensions:	15.24 * 11.40 * 8.25mm

### Input specifications

Item	Test conditions	Min	Typ	Max	Units
No load input current			0.2	1.5	mA
Reverse polarity input	Avoid / Not protected				
Input filter	Capacitor Capacitance filter				
Remote ON/OFF*	<ul style="list-style-type: none"> <li>• Module switch on</li> <li>• Module switch off</li> <li>• Input current when switched off</li> </ul>		suspended or connected to TTL high level (3.2-5.5VDC) pin connected to GND or low level (0-0.8VDC)	0.2	1 mA

\* The voltage of Remote ON/OFF pin is relative to pin GND.

### Output specifications

Item	Test conditions	Min	Typ	Max	Units
Output voltage accuracy	Input voltage range at full load • 1.5/1.8/2.5/3.3VDC • Others		±2 ±2	±4 ±3	% %
Line regulation	Input voltage range at full load		±0.2	±0.4	%
Load regulation	Nominal input, 10% to 100% load • 1.5/1.8/2.5VDC • Others		0.8 0.3	±1.5 ±0.6	% %
Ripple + Noise*	20MHz bandwidth 1.5/1.8/2.5/3.3VDC • 20% - 100% load • < 20% load Others • 10% - 100% load • < 10% load		30 30	75 75	mVp-p mVp-p
Temperature coefficient	- 40°C to + 85°C ambient			±0.03	%/°C
Transient response deviation	Nominal input voltage, 25% load step change		50	150	mV
Transient recovery time	Nominal input voltage, 25% load step change		0.2	1	ms
Vadj	input voltage range		±10		%Vo
Switching frequency	Full load, nominal input voltage • 1.5/1.8/2.5VDC • 3.3/5/6.5VDC • 09/12VDC		370 520 700		KHz KHz KHz

\* Ripple and noise tested with "parallel cable" method, please refer to DC-DC

### Example:

**LMT78\_05-1.0R**

LM = Series; T = SMT case; 05 = 5Vout; 1.0 = 1.0A; R = Revised

### Note:

- All specifications measured at Ta = 25°C, humidity <75%, nominal input voltage and rated output load unless otherwise specified.
- In this datasheet, all the test methods of indications are based on corporate standards.

## LMT78\_1.0R series

Wide input, non-isolated & regulated, single output, SMD package

### EMC specifications

EMI	CE	CISPR32/EN55032	CLASS B	(see EMC recommended circuit, ②)
EMI	RE	CISPR32/EN55032	CLASS B	(see EMC recommended circuit, ②)
EMS	ESD	IEC/EN61000-4-2	Contact $\pm 4\text{kV}$	perf. Criteria B
EMS	RS	IEC/EN61000-4-3	10V/m	perf. Criteria A
EMS	EFT	IEC/EN61000-4-4	$\pm 1\text{kV}$	perf. Criteria B (see EMC recommended circuit, ①)
EMS	Surge	IEC/EN61000-4-5	line to line $\pm 1\text{kV}$	perf. Criteria B (see EMC recommended circuit, ①)
EMS	CS	IEC/EN61000-4-6	3 V.r.m.s	perf. Criteria A

Part Number	Input Voltage [VDC]		Output Voltage [VDC]	Output Current [mA, Max]	Capacitive load [ $\mu\text{F}$ , max]	Efficiency [Vin. max]
	Nominal	Range				
LMT78_1.5-1.0R	12	4.75-32	1.5	1000	680	66
LMT78_1.8-1.0R	12	4.75-32	1.8	1000	680	69
LMT78_02-1.0R	12	4.75-32	2.5	1000	680	74
LMT78_03-1.0R	24	6.5-36	3.3	1000	680	80
LMT78_05-1.0R	24	8-36	5	1000	680	85
LMT78_6.5-1.0R	24	10-36	6.5	1000	680	86
LMT78_09-1.0R	24	13-36	9	1000	680	89
LMT78_12-1.0R	24	16-36	12	800	680	92
LMT78_15-1.0R	24	20-36	15	800	680	92

## Typical characteristics

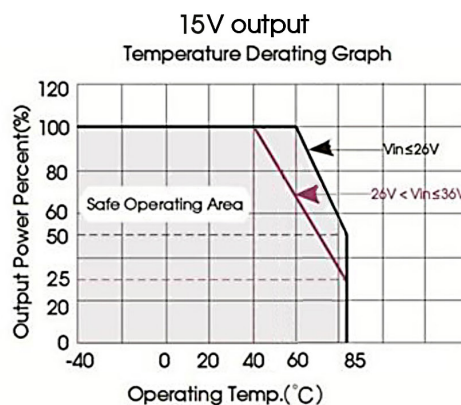
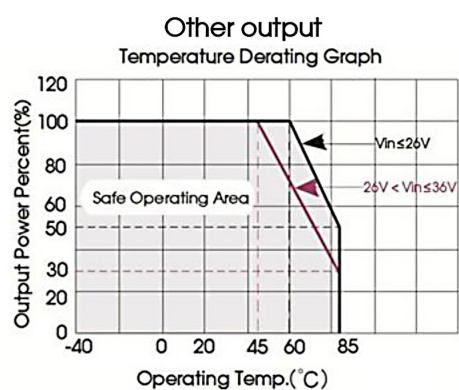
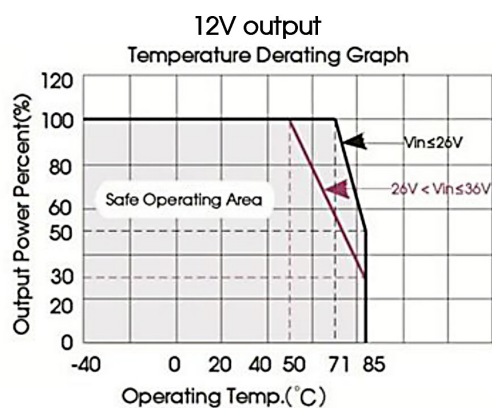
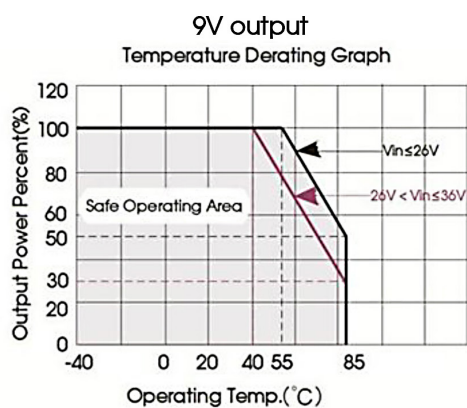

## LMT78\_1.0R series

Wide input, non-isolated & regulated, single output, SMD package

### Efficiency

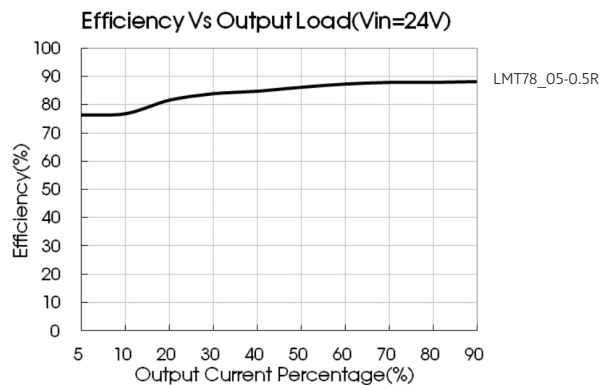
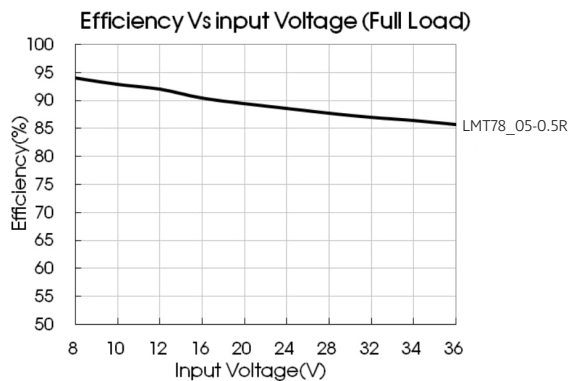

### Typical application circuit

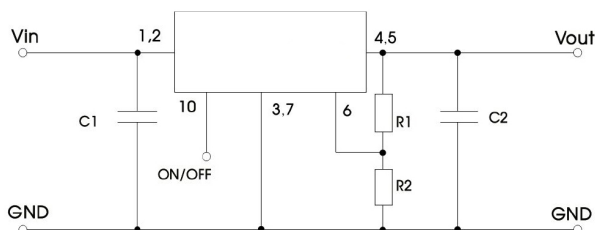

**Note:**

- C1 and C2 are required and should be connected close to the pin terminal of the module.
- The capacitance of C1 and C2 refer to table 1, it can be increased properly if required, and tantalum or low ESR electrolytic capacitors may also suffice.
- Cannot be used in parallel for output and hot swap. To reduce the output ripple furtherly, it is suggested to connect a "LC" filter at the output terminal, and recommended value of L is 10μH-47μH.

Part number	C1 (ceramic capacitor)	C2 (ceramic capacitor)	Ra1/Ra2 (Vadj resistance)
LMT78_1.5-1.0R	10μF/50V	22μF/10V	Refer to Vadj resistance calculation
LMT78_1.8-1.0R	10μF/50V	22μF/10V	
LMT78_02-1.0R	10μF/50V	22μF/10V	
LMT78_03-1.0R	10μF/50V	22μF/10V	
LMT78_05-1.0R	10μF/50V	22μF/16V	
LMT78_6.5-1.0R	10μF/50V	22μF/16V	
LMT78_09-1.0R	10μF/50V	22μF/16V	
LMT78_12-1.0R	10μF/50V	22μF/25V	
LMT78_15-1.0R	10μF/50V	22μF/25V	

## LMT78\_1.0R series

Wide input, non-isolated & regulated, single output, SMD package

### LC filter application circuit

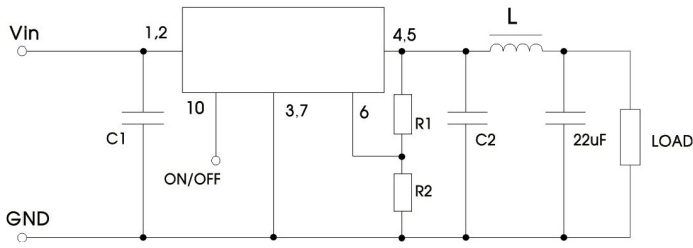

### EMC solution-recommended circuit

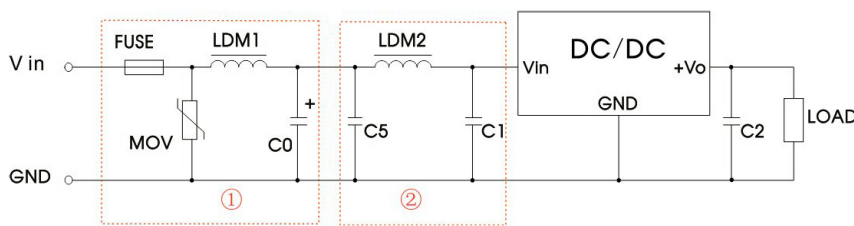

FUSE	Selected based on the actual input current from the customer
MOV	S20K30
LDM1	82μH
C0	680μF/50V
C2	refer to Table 1
C1/C5	4.7μF/50V
LDM2	68μH

Note: Part ① in the Fig. 4 is for EMS test, part ② is for EMI filtering; parts ① and ② can be added based on actual requirement.

### Application of Vadj and calculation of Vadj resistance

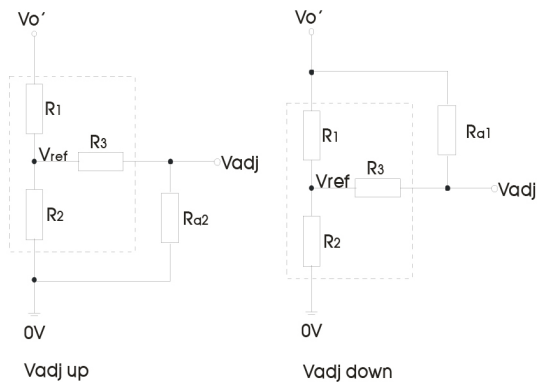

Applied circuits of Vadj (Part in broken line is the interior of models)

Calculation formula of Vadj resistance:

$$\begin{aligned} \text{up: } R_{a2} &= \frac{\alpha R_2}{R_2 - \alpha} - R_3 & \alpha &= \frac{V_{ref}}{V_o' - V_{ref}} \cdot R_1 \\ \text{down: } R_{a1} &= \frac{\alpha R_1}{R_1 - \alpha} - R_3 & \alpha &= \frac{V_o' - V_{ref}}{V_{ref}} \cdot R_2 \end{aligned}$$

$R_{a1}$ ,  $R_{a2}$  is Vadj resistance,  $\alpha$  is a self-defined parameter, with no real meaning.  $V_o'$  for the actual needs of the up or down regulated voltage

Vout (V)	R1 (KΩ)	R2 (KΩ)	R3 (KΩ)	Vref (V)
1.5	7.5	7.5	15	0.75
1.8	4.7	3.3	6.8	0.75
2.5	9.1	3.9	8.2	0.75
3.3	75	22	75	0.75
5	43	7.5	33	0.75
6.5	43	5.6	22	0.75
9	43	3.9	22	0.75
12	36	2.4	10	0.75
15	82	4.3	20	0.75

Note: The 1.5VDC output model only support Vadj up, do not support Vadj down.

## LMT78\_1.0R series

Wide input, non-isolated & regulated, single output, SMD package

### Mechanical dimensions

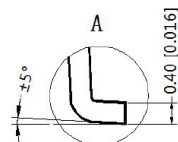
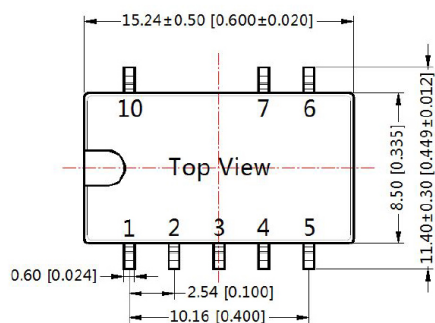

THIRD ANGLE PROJECTION

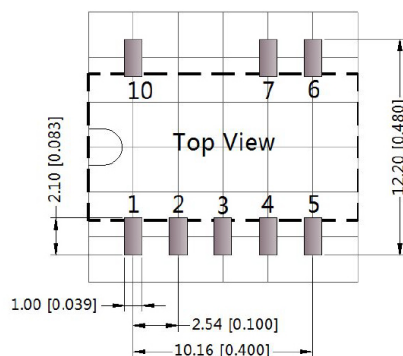

Note: Grid 2.54\*2.54mm

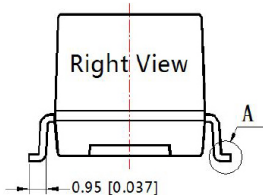
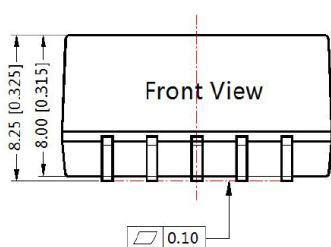

**Note:**

Unit: mm[inch]

Pin selection tolerances:  $\pm 0.10\text{mm}$  [ $\pm 0.004\text{inch}$ ]

General tolerances:  $\pm 0.25\text{mm}$  [ $\pm 0.010\text{inch}$ ]

General tolerances:  $\pm 0.25[\pm 0.010]$

Pin-Out	
Pin	Function
1	+Vin
2	+Vin
3	GND
4	+Vout
5	+Vout
6	V adj
7	GND
10	Remote On/Off

NC: Pin to be isolated from circuitry