

NOTES:

1. MATERIAL:
HOUSING: NYLON, GLASS-FILLED, UL94V-0,
COLOR: BLACK
PIN: 0.50mm SQ. COPPER ALLOY
2. PLATING FINISH:
 - 1) 15µin MIN. GOLD PLATE IN SELECTED AREA AND 80µin MIN. TIN ON SOLDER TAIL OVER 50µin MIN. NICKEL UNDERPLATE OVERALL.
 - 2) 30µin MIN. GOLD PLATE IN SELECTED AREA AND 80µin MIN. TIN ON SOLDER TAIL OVER 50µin MIN. NICKEL UNDERPLATE OVERALL.
 - 3) 100µin MIN. TIN OVERALL 50µin MIN. NICKEL UNDERPLATE OVERALL.
 - 4) 2-10µin MIN. GOLD OVER 50µin MIN. NICKEL UNDERPLATE OVERALL.
3. PACKAGING: SEE TABLE
4. RECOMMENDED PCB THICKNESS: 1.60±0.10mm
5. PRODUCT SPECIFICATION: PS-87761-100
6. WAFER TO BE FLAT WITHIN 0.003mm/mm
- 7 BEND DEPRESSION IS ACCEPTED SO LONG AS IT DOES NOT AFFECT THE OVERALL COPLANARITY OF TAIL
- 8 COPLANARITY IS TO BE MEASURED BY RESTING THE SOLDER TAIL ON A FLAT SURFACE
- 9 CAP LOCATION IS CENTERED ALONG THE MATING ENDS AS SHOWN. TOP SURFACE OF CAP TO BE FLAT FOR THE PURPOSE OF PICK & PLACE BY VACUUM SUCTION NOZZLE
10. CKT 4 & 6 IS CUT FROM CKT 8 & 12 RESPECTIVELY. ROUGH EDGES ARE EXPECTED ALONG THE CUTTING EDGES
11. THE ABOVE 8CKTS SHOWN IS FOR ILLUSTRATION ONLY.
12. TUBE LENGTH : 560mm REF.

SYMBOLS	THIS DRAWING CONTAINS INFORMATION THAT IS PROPRIETARY TO MOLEX ELECTRONIC TECHNOLOGIES, LLC AND SHOULD NOT BE USED WITHOUT WRITTEN PERMISSION		CURRENT REV DESC: REMASTERED IN NX		
	DIMENSION UNITS	SCALE			
▽ = 0	mm	NTS			2.00MM PITCH DUAL ROW HDR, SINGLE WAFER, SMT
▽ = 0	GENERAL TOLERANCES (UNLESS SPECIFIED)				PRODUCT CUSTOMER DRAWING
▽ = 0					
▽ = 0	4 PLACES ±		EC NO: 614469		DOCUMENT NUMBER
▽ = 0	3 PLACES ±		DRWN: GJEEVANSURES	2019/02/12	
▽ = 0	2 PLACES ±	0.2	CHK'D: GJEEVANSURES	2019/04/10	DOC TYPE
▽ = 0	1 PLACE ±		APPR: ISHWARG	2019/04/15	DOC PART
▽ = 0	0 PLACES ±		INITIAL REVISION:		REVISION
▽ = 0	ANGULAR TOL ±	3.0°	DRWN: SKLIM01	2006/03/23	GENERAL MARKET
▽ = 0	DRAFT WHERE APPLICABLE MUST REMAIN WITHIN DIMENSIONS		APPR: PATEY	2006/03/29	
▽ = 0	THIRD ANGLE PROJECTION		DRAWING	SERIES	1 OF 12
▽ = 0			A3-SIZE	87759	
DOCUMENT STATUS		P1	RELEASE DATE	2019/04/15	06:29:54

PARTS PACK IN TUBE ORIENTATION

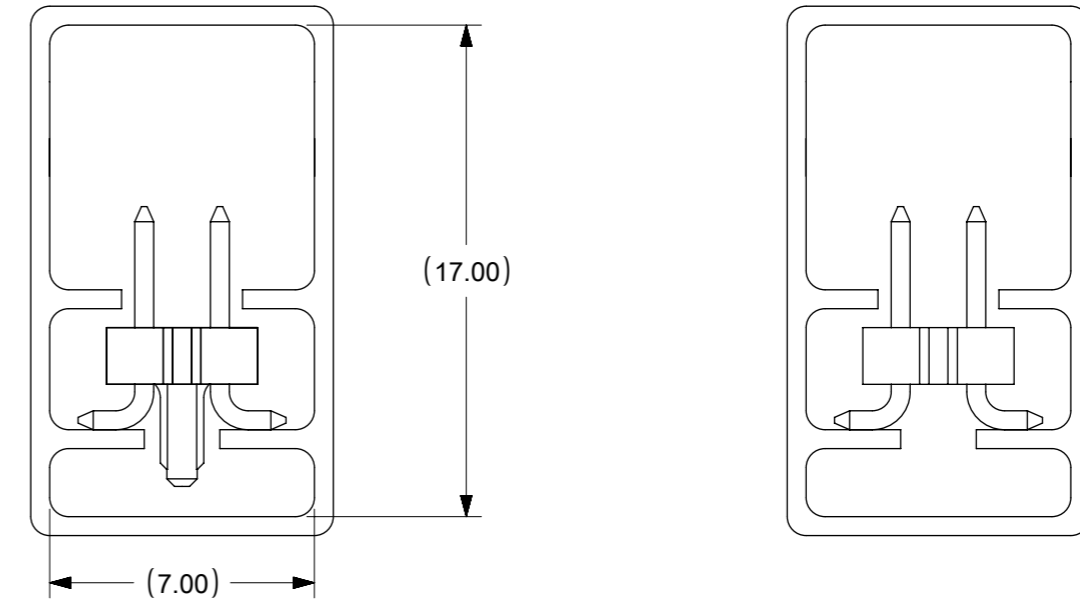

PART WITHOUT CAP IN TUBE
(PLS REFER TO PK SPEC: PK-89990-475)

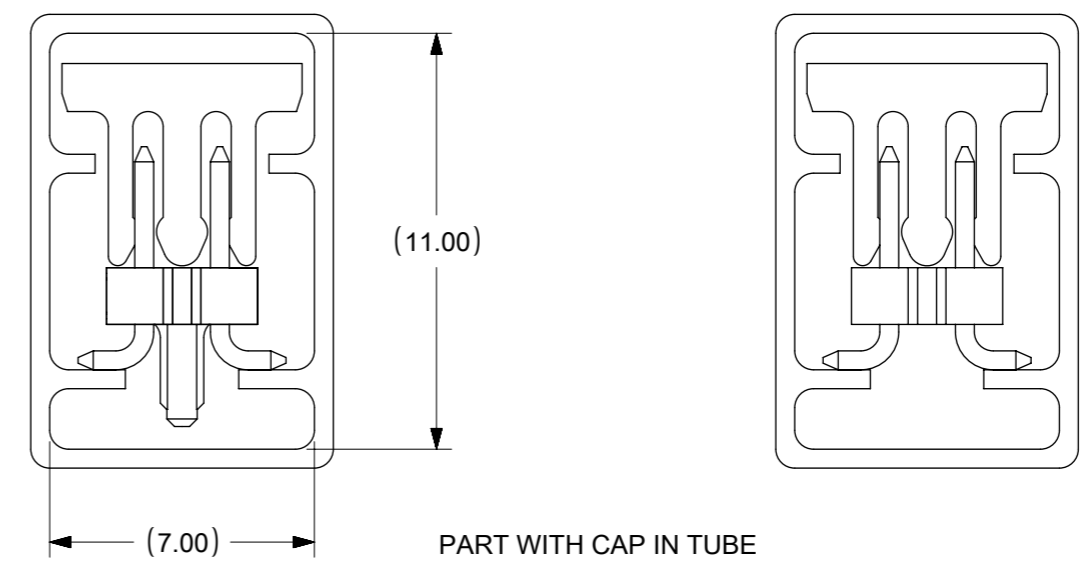

PART WITH CAP IN TUBE
(PLS REFER TO PK SPEC: PK-89990-476)

CIRCUITS POSITION CONFIGURATION

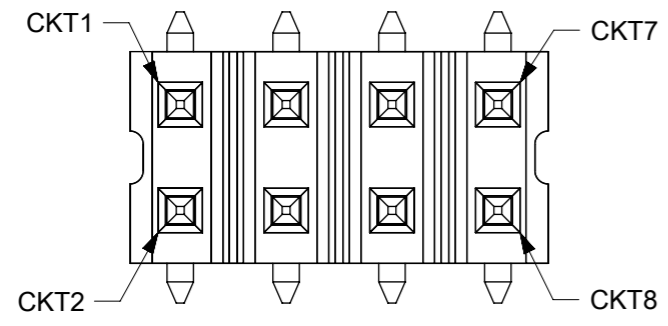

THIS DRAWING CONTAINS INFORMATION THAT IS PROPRIETARY TO MOLEX ELECTRONIC TECHNOLOGIES, LLC AND SHOULD NOT BE USED WITHOUT WRITTEN PERMISSION									
SYMBOLS	DIMENSION UNITS		SCALE		CURRENT REV DESC: REMASTERED IN NX				
	$\nabla = 0$	mm	NTS		molex CUSTOM HEADER 2.00MM PITCH DUAL ROW HDR, SINGLE WAFER, SMT				
$\nabla = 0$	GENERAL TOLERANCES (UNLESS SPECIFIED)								
$\nabla = 0$			MM	INCH	EC NO: 614469 DRWN: GJEEVANSURES 2019/02/12 CHK'D: GJEEVANSURES 2019/04/10 APPR: ISHWARG 2019/04/15				
$\nabla = 0$	4 PLACES	\pm	\pm						
$\nabla = 0$	3 PLACES	\pm	\pm		INITIAL REVISION: DRWN: SKLIM01 2006/03/23 APPR: PATEY 2006/03/29				
$\nabla = 0$	2 PLACES	\pm	0.2	\pm					
$\nabla = 0$	1 PLACE	\pm	\pm		DOCUMENT NUMBER		DOC TYPE	DOC PART	REVISION
$\nabla = 0$	0 PLACES	\pm	\pm		SD-87759-277		PSD	001	B3
$\nabla = 0$	ANGULAR TOL		\pm	3.0°	MATERIAL NUMBER		CUSTOMER		SHEET NUMBER
$\nabla = 0$	DRAFT WHERE APPLICABLE MUST REMAIN WITHIN DIMENSIONS		THIRD ANGLE PROJECTION		DRAWING	SERIES	GENERAL MARKET		2 OF 12
$\nabla = 0$					A3-SIZE	87759	SEE TABLE		

WITH CAP IN TAPE & REEL PACKAGING
 THE 8CKTS SHOWN AS ABOVE IS FOR
 ILLUSTRATION PURPOSE ONLY.
 (THIS TYPE E/TAPE USED FOR CKT 8 TO 14)
 (PLS REFER TO PK SPEC: PK-89990-484)

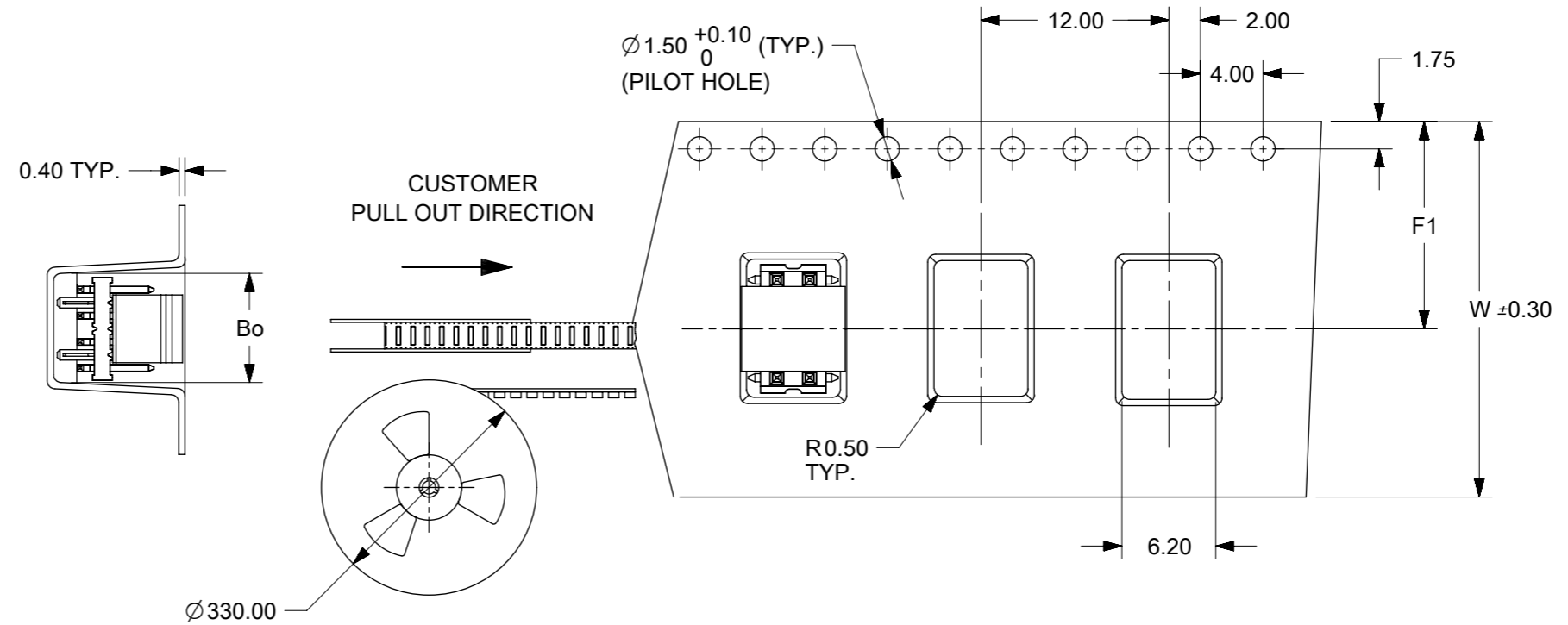

EMBOSSSED CARRIER TAPE TYPE "A"

NOTES:

1. LEADER AND TRAILER TAPE

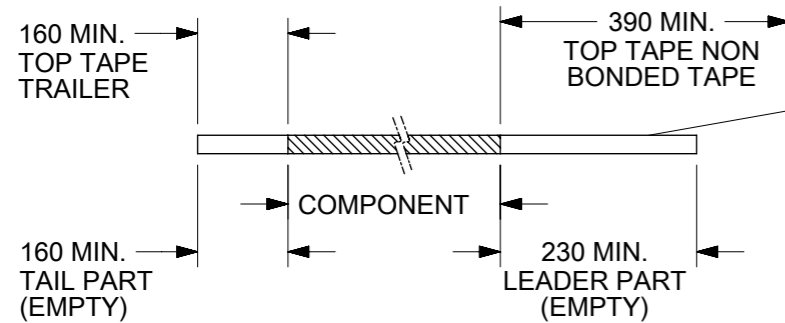

**2. PEELING OFF FORCE OF THE TOP TAPE: 20 - 80gf.
 (PEELING DIRECTION AS SHOWN IN FOLLOWING FIGURE)**

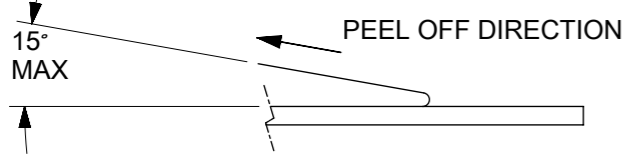

- 3. TAPE & REEL SPECIFICATION IS AS PER EIA-481.
- 4. TAPE & REEL QUANTITY = 500 PCS/REEL
- 5. THE TAPE IS TREATED FOR ANTI-STATIC

SYMBOLS	THIS DRAWING CONTAINS INFORMATION THAT IS PROPRIETARY TO MOLEX ELECTRONIC TECHNOLOGIES, LLC AND SHOULD NOT BE USED WITHOUT WRITTEN PERMISSION		CURRENT REV DESC: REMASTERED IN NX		molex
	DIMENSION UNITS	SCALE			
▽ = 0	mm	NTS			2.00MM PITCH DUAL ROW HDR, SINGLE WAFER, SMT
▽ = 0	GENERAL TOLERANCES (UNLESS SPECIFIED)				PRODUCT CUSTOMER DRAWING
▽ = 0					
▽ = 0	4 PLACES	±			DOCUMENT NUMBER
▽ = 0	3 PLACES	±			
▽ = 0	2 PLACES	±	0.2		DOC TYPE
▽ = 0	1 PLACE	±			DOC PART
▽ = 0	0 PLACES	±			REVISION
▽ = 0	ANGULAR TOL		±	3.0°	
■ = 0	DRAFT WHERE APPLICABLE MUST REMAIN WITHIN DIMENSIONS		THIRD ANGLE PROJECTION	DRAWING	SERIES
▽ = 0				A3-SIZE	87759
			MATERIAL NUMBER	CUSTOMER	SHEET NUMBER
			SEE TABLE	GENERAL MARKET	3 OF 12

WITH CAP IN TAPE & REEL PACKAGING
 THE 24CKTS SHOWN ABOVE
 IS FOR ILLUSTRATION ONLY.
 (THIS TYPE E/TAPE USED FOR CKT 16 TO 50)
 (PLS REFER TO PK SPEC: PK-89990-484)

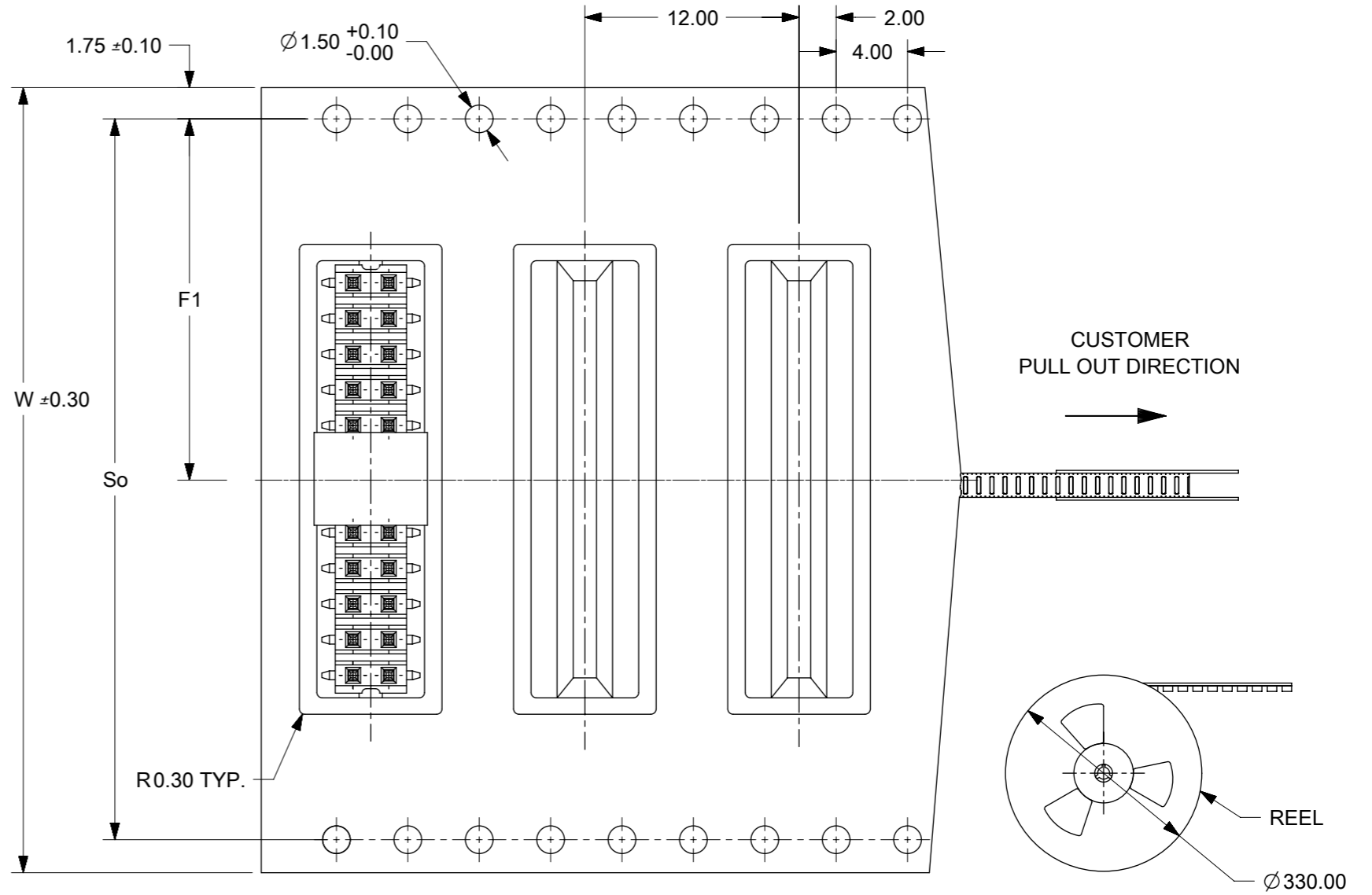
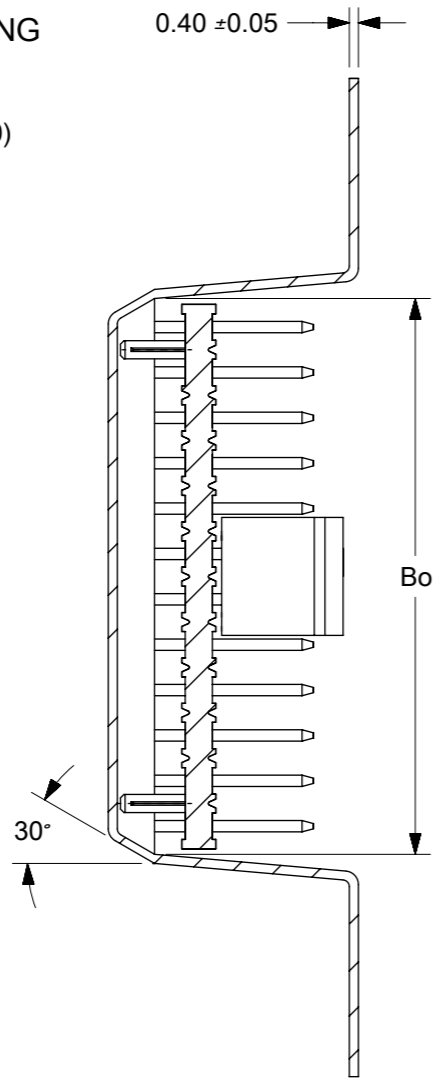

EMBOSSED CARRIER TAPE TYPE "B"

- NOTES:
 1. LEADER AND TRAILER TAPE

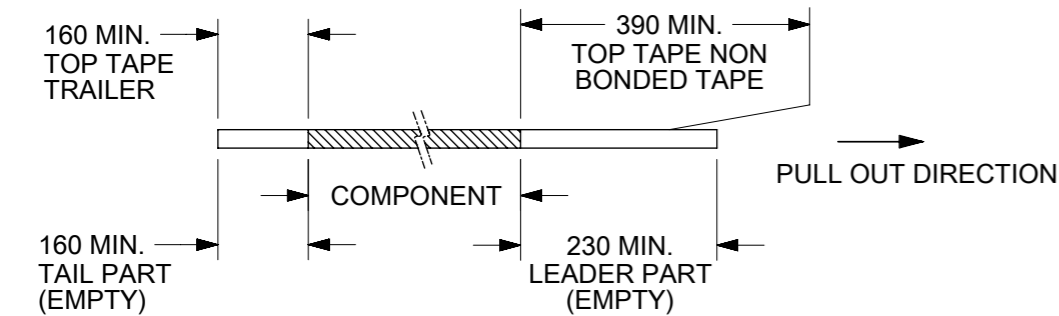

2. PEELING OFF FORCE OF THE TOP TAPE: 20 - 80gf.
 (PEELING DIRECTION AS SHOWN IN FOLLOWING FIGURE)



3. TAPE & REEL SPECIFICATION IS AS PER EIA-481.
 4. TAPE & REEL QUANTITY = 500 PCS/REEL
 5. THE TAPE IS TREATED FOR ANTI-STATIC

SYMBOLS		THIS DRAWING CONTAINS INFORMATION THAT IS PROPRIETARY TO MOLEX ELECTRONIC TECHNOLOGIES, LLC AND SHOULD NOT BE USED WITHOUT WRITTEN PERMISSION		CURRENT REV DESC: REMASTERED IN NX	
▽ = 0	mm	SCALE		NTS	
▽ = 0	GENERAL TOLERANCES (UNLESS SPECIFIED)				
▽ = 0		MM	INCH		
▽ = 0	4 PLACES	±	±	EC NO: 614469	
▽ = 0	3 PLACES	±	±	DRWN: GJEEVANSURES 2019/02/12	
▽ = 0	2 PLACES	±	0.2	CHK'D: GJEEVANSURES 2019/04/10	
▽ = 0	1 PLACE	±	±	APPR: ISHWARG 2019/04/15	
▽ = 0	0 PLACES	±	±	INITIAL REVISION:	
▽ = 0	ANGULAR TOL	±	3.0°	DRWN: SKLIM01 2006/03/23	
▽ = 0	DRAFT WHERE APPLICABLE MUST REMAIN WITHIN DIMENSIONS		THIRD ANGLE PROJECTION	DRAWING	SERIES
▽ = 0				A3-SIZE	87759
DOCUMENT STATUS		P1	RELEASE DATE	2019/04/15	06:29:54
DOCUMENT NUMBER		CUSTOMER		DOC TYPE	DOC PART
SD-87759-277		GENERAL MARKET		PSD	001
SHEET NUMBER		REVISION		B3	
4 OF 12					

10	9	8	7	6	5	4	3	2	1										
PART NUMBER WITHOUT CAP IN TRAY	PART NUMBER WITHOUT CAP IN TUBE	PART NUMBER WITH CAP IN TUBE	PART NUMBER WITH CAP IN TAPE & REEL	CKT SIZE	PEG	PLATING TYPE	VOID POSITION	A	B	C	M	(F)	(G)	Bo	F1	So	W	EMBOSSSED TYPE	
F	87759-0461	----	----	4	N	1	----	3.90	2.00	---	3.20	5.90	8.10	---	---	---	---	---	
	87759-0462	----	----	4	N	2	----	3.90	2.00	---	3.20	5.90	8.10	---	---	---	---	---	
	87759-0463	----	87759-0493	4	N	3	----	3.90	2.00	---	3.20	5.90	8.10	---	---	---	---	---	
	87759-0661	----	----	6	N	1	----	7.90	6.00	---	3.20	5.90	8.10	---	---	---	---	---	
E	87759-0662	----	----	6	N	2	----	7.90	6.00	---	3.20	5.90	8.10	---	---	---	---	---	
	87759-0663	----	----	6	N	3	----	7.90	6.00	---	3.20	5.90	8.10	---	---	---	---	---	
	----	87759-0861	87759-0871	87759-0881	8	N	1	----	7.90	6.00	---	3.20	5.90	8.10	8.50	11.50	---	24.00	A
	----	87759-0862	87759-0872	87759-0882	8	N	2	----	7.90	6.00	---	3.20	5.90	8.10	8.50	11.50	---	24.00	A
	----	87759-0863	87759-0873	87759-0883	8	N	3	----	7.90	6.00	---	3.20	5.90	8.10	8.50	11.50	---	24.00	A
D	----	87759-6081	87759-7081	87759-8081	8	Y	1	----	7.90	6.00	4.00	3.20	5.90	8.10	8.50	11.50	---	24.00	A
	----	87759-6082	87759-7082	87759-8082	8	Y	2	----	7.90	6.00	4.00	3.20	5.90	8.10	8.50	11.50	---	24.00	A
	----	87759-6083	87759-7083	87759-8083	8	Y	3	----	7.90	6.00	4.00	3.20	5.90	8.10	8.50	11.50	---	24.00	A

10	9	8	7	6	5	4	3	2	1
C									
B									
A									

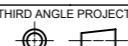
SYMBOLS	THIS DRAWING CONTAINS INFORMATION THAT IS PROPRIETARY TO MOLEX ELECTRONIC TECHNOLOGIES, LLC AND SHOULD NOT BE USED WITHOUT WRITTEN PERMISSION												
	DIMENSION UNITS		SCALE		CURRENT REV DESC: REMASTERED IN NX								
	mm		NTS										
	GENERAL TOLERANCES (UNLESS SPECIFIED)				EC NO: 614469						CUSTOM HEADER		
4 PLACES ±				DRWN: GJEEVANSURES 2019/02/12						2.00MM PITCH DUAL ROW HDR, SINGLE WAFER, SMT			
3 PLACES ±				CHK'D: GJEEVANSURES 2019/04/10									
2 PLACES ± 0.2				APPR: ISHWARG 2019/04/15						PRODUCT CUSTOMER DRAWING			
1 PLACE ±				INITIAL REVISION:						DOCUMENT NUMBER			
0 PLACES ±				DRWN: SKLIM01 2006/03/23						SD-87759-277			
ANGULAR TOL ± 3.0°				APPR: PATEY 2006/03/29						DOC TYPE	DOC PART	REVISION	
DRAFT WHERE APPLICABLE MUST REMAIN WITHIN DIMENSIONS				THIRD ANGLE PROJECTION		DRAWING	SERIES	MATERIAL NUMBER	CUSTOMER		SHEET NUMBER		
						A3-SIZE	87759	SEE TABLE	GENERAL MARKET		5 OF 12		

10	9	8	7	6	5	4	3	2	1										
PART NUMBER WITHOUT CAP IN TUBE	PART NUMBER WITH CAP IN TUBE	PART NUMBER WITH CAP IN TAPE & REEL	PART NUMBER WITHOUT CAP IN TRAY	CKT SIZE	PEG	PLATING TYPE	VOID POSITION	A	B	C	M	(F)	(G)	Bo	F1	So	W	EMBOSSED TYPE	
F	87759-1061	87759-1071	87759-1081	-----	10	N	1	----	9.90	8.00	---	3.20	5.90	8.10	10.50	11.50	---	24.00	A
	87759-1062	87759-1072	87759-1082	-----	10	N	2	----	9.90	8.00	---	3.20	5.90	8.10	10.50	11.50	---	24.00	A
	87759-1063	87759-1073	87759-1083	-----	10	N	3	----	9.90	8.00	---	3.20	5.90	8.10	10.50	11.50	---	24.00	A
	87759-6101	87759-7101	87759-8101	-----	10	Y	1	----	9.90	8.00	6.00	3.20	5.90	8.10	10.50	11.50	---	24.00	A
	87759-6102	87759-7102	87759-8102	-----	10	Y	2	----	9.90	8.00	6.00	3.20	5.90	8.10	10.50	11.50	---	24.00	A
E	87759-6103	87759-7103	87759-8103	-----	10	Y	3	----	9.90	8.00	6.00	3.20	5.90	8.10	10.50	11.50	---	24.00	A
	87759-1070	87759-7030	87759-7010	-----	10	Y	1	----	9.90	8.00	6.00	3.60	6.50	8.70	10.50	11.50	---	24.00	A
	87759-1261	87759-1271	87759-1281	-----	12	N	1	----	11.90	10.00	---	3.20	5.90	8.10	12.50	11.50	---	24.00	A
	87759-1262	87759-1272	87759-1282	-----	12	N	2	----	11.90	10.00	---	3.20	5.90	8.10	12.50	11.50	---	24.00	A
	87759-1263	87759-1273	87759-1283	-----	12	N	3	----	11.90	10.00	---	3.20	5.90	8.10	12.50	11.50	---	24.00	A
D	87759-6121	87759-7121	87759-8121	-----	12	Y	1	----	11.90	10.00	---	3.20	5.90	8.10	12.50	11.50	---	24.00	A
	87759-6122	87759-7122	87759-8122	-----	12	Y	2	----	11.90	10.00	---	3.20	5.90	8.10	12.50	11.50	---	24.00	A
	87759-6123	87759-7123	87759-8123	-----	12	Y	3	----	11.90	10.00	---	3.20	5.90	8.10	12.50	11.50	---	24.00	A
	----	----	----	87759-0005	12	N	4	----	11.90	10.00	---	4.57	7.57	---	---	---	---	---	---
C	87759-1461	87759-1471	87759-1481	-----	14	N	1	----	13.90	12.00	---	3.20	5.90	8.10	14.50	11.50	---	24.00	A
	87759-1462	87759-1472	87759-1482	-----	14	N	2	----	13.90	12.00	---	3.20	5.90	8.10	14.50	11.50	---	24.00	A
	87759-1463	87759-1473	87759-1483	-----	14	N	3	----	13.90	12.00	---	3.20	5.90	8.10	14.50	11.50	---	24.00	A
	87759-6141	87759-7141	87759-8141	-----	14	Y	1	----	13.90	12.00	---	3.20	5.90	8.10	14.50	11.50	---	24.00	A
	87759-6142	87759-7142	87759-8142	-----	14	Y	2	----	13.90	12.00	---	3.20	5.90	8.10	14.50	11.50	---	24.00	A
	87759-6143	87759-7143	87759-8143	-----	14	Y	3	----	13.90	12.00	---	3.20	5.90	8.10	14.50	11.50	---	24.00	A
	----	----	87759-0003	-----	14	Y	1	----	13.90	12.00	---	4.00	6.70	8.05	14.20	11.50	---	24.00	A
B	87759-1470	87759-7032	87759-7012	-----	14	Y	1	----	13.90	12.00	6.00	3.60	6.50	8.70	14.50	11.50	---	24.00	A

<p>SYMBOLS</p> <p>▽ = 0</p> <p>▽ = 0</p> <p>▽ = 0</p> <p>▽ = 0</p> <p>▽ = 0</p> <p>▽ = 0</p> <p>▽ = 0</p> <p>▽ = 0</p> <p>▽ = 0</p> <p>▽ = 0</p>										<p>THIS DRAWING CONTAINS INFORMATION THAT IS PROPRIETARY TO MOLEX ELECTRONIC TECHNOLOGIES, LLC AND SHOULD NOT BE USED WITHOUT WRITTEN PERMISSION</p> <p>DIMENSION UNITS: mm</p> <p>SCALE: NTS</p> <p>GENERAL TOLERANCES (UNLESS SPECIFIED)</p> <table border="1"> <tr> <th></th> <th>MM</th> <th>INCH</th> </tr> <tr> <td>4 PLACES</td> <td>±</td> <td>±</td> </tr> <tr> <td>3 PLACES</td> <td>±</td> <td>±</td> </tr> <tr> <td>2 PLACES</td> <td>± 0.2</td> <td>±</td> </tr> <tr> <td>1 PLACE</td> <td>±</td> <td>±</td> </tr> <tr> <td>0 PLACES</td> <td>±</td> <td>±</td> </tr> </table> <p>ANGULAR TOL ± 3.0°</p> <p>DRAFT WHERE APPLICABLE MUST REMAIN WITHIN DIMENSIONS</p>											MM	INCH	4 PLACES	±	±	3 PLACES	±	±	2 PLACES	± 0.2	±	1 PLACE	±	±	0 PLACES	±	±	<p>CURRENT REV DESC: REMASTERED IN NX</p> <p>EC NO: 614469</p> <p>DRWN: GJEEVANSURES 2019/02/12</p> <p>CHK'D: GJEEVANSURES 2019/04/10</p> <p>APPR: ISHWARG 2019/04/15</p> <p>INITIAL REVISION:</p> <p>DRWN: SKLIM01 2006/03/23</p> <p>APPR: PATEY 2006/03/29</p> <p>THIRD ANGLE PROJECTION</p> <p>DRAWING: A3-SIZE</p> <p>SERIES: 87759</p>										<p>molex</p> <p>CUSTOM HEADER</p> <p>2.00MM PITCH DUAL ROW HDR, SINGLE WAFER, SMT</p> <p>PRODUCT CUSTOMER DRAWING</p> <p>DOCUMENT NUMBER: SD-87759-277</p> <p>DOC TYPE: PSD</p> <p>DOC PART: 001</p> <p>REVISION: B3</p> <p>MATERIAL NUMBER: SEE TABLE</p> <p>CUSTOMER: GENERAL MARKET</p> <p>SHEET NUMBER: 6 OF 12</p>									
	MM	INCH																																																							
4 PLACES	±	±																																																							
3 PLACES	±	±																																																							
2 PLACES	± 0.2	±																																																							
1 PLACE	±	±																																																							
0 PLACES	±	±																																																							
<p>DOCUMENT STATUS: P1</p> <p>RELEASE DATE: 2019/04/15</p> <p>06:29:54</p>																																																									

10	9	8	7	6	5	4	3	2	1									
PART NUMBER WITHOUT CAP IN TUBE	PART NUMBER WITH CAP IN TUBE	PART NUMBER WITH CAP IN TAPE & REEL	CKT SIZE	PEG	PLATING TYPE	VOID POSITION	A	B	C	M	(F)	(G)	Bo	F1	So	W	EMBOSSED TYPE	
F	87759-1661	87759-1671	87759-1681	16	N	1	----	15.90	14.00	---	3.20	5.90	8.10	16.50	14.20	28.40	32.00	B
	87759-1662	87759-1672	87759-1682	16	N	2	----	15.90	14.00	---	3.20	5.90	8.10	16.50	14.20	28.40	32.00	B
	87759-1663	87759-1673	87759-1683	16	N	3	----	15.90	14.00	---	3.20	5.90	8.10	16.50	14.20	28.40	32.00	B
	87759-6161	87759-7161	87759-8161	16	Y	1	----	15.90	14.00	---	3.20	5.90	8.10	16.50	14.20	28.40	32.00	B
	87759-6162	87759-7162	87759-8162	16	Y	2	----	15.90	14.00	---	3.20	5.90	8.10	16.50	14.20	28.40	32.00	B
E	87759-6163	87759-7163	87759-8163	16	Y	3	----	15.90	14.00	---	3.20	5.90	8.10	16.50	14.20	28.40	32.00	B
	87759-1611	87759-1612	87759-1613	16	N	4	----	15.90	14.00	---	5.50	8.20	9.60	16.50	14.20	28.40	32.00	B
	87759-1670	87759-7033	87759-7013	16	Y	1	----	15.90	14.00	12.20	3.60	6.50	8.70	16.50	16.50	28.40	28.40	B
	87759-6737	877596707	87759-1667	16	Y	1	----	15.90	14.00	12.00	6.80	9.50	10.83	16.40	14.20	28.40	32.00	B
	87759-1861	87759-1871	87759-1881	18	N	1	----	17.90	16.00	---	3.20	5.90	8.10	18.50	14.20	28.40	32.00	B
D	87759-1862	87759-1872	87759-1882	18	N	2	----	17.90	16.00	---	3.20	5.90	8.10	18.50	14.20	28.40	32.00	B
	87759-1863	87759-1873	87759-1883	18	N	3	----	17.90	16.00	---	3.20	5.90	8.10	18.50	14.20	28.40	32.00	B
	87759-6181	87759-7181	87759-8181	18	Y	1	----	17.90	16.00	---	3.20	5.90	8.10	18.50	14.20	28.40	32.00	B
	87759-6182	87759-7182	87759-8182	18	Y	2	----	17.90	16.00	---	3.20	5.90	8.10	18.50	14.20	28.40	32.00	B
	87759-6183	87759-7183	87759-8183	18	Y	3	----	17.90	16.00	---	3.20	5.90	8.10	18.50	14.20	28.40	32.00	B
	----	87759-0002	87759-0001	18	Y	1	----	17.90	16.00	14.00	10.30	13.00	14.31	18.40	20.20	40.40	44.00	B
C		87759-1820		18	N	4	---	17.90	16.00	---	8.40	11.10	12.47	18.40	20.20	40.40	44.00	B
	87759-2061	87759-2071	87759-2081	20	N	1	----	19.90	18.00	---	3.20	5.90	8.10	20.50	20.20	40.40	44.00	B
	87759-2062	87759-2072	87759-2082	20	N	2	----	19.90	18.00	---	3.20	5.90	8.10	20.50	20.20	40.40	44.00	B
	87759-2063	87759-2073	87759-2083	20	N	3	----	19.90	18.00	---	3.20	5.90	8.10	20.50	20.20	40.40	44.00	B
B	87759-6201	87759-7201	87759-8201	20	Y	1	----	19.90	18.00	---	3.20	5.90	8.10	20.50	20.20	40.40	44.00	B
	87759-6202	87759-7202	87759-8202	20	Y	2	----	19.90	18.00	---	3.20	5.90	8.10	20.50	20.20	40.40	44.00	B

SYMBOLS										THIS DRAWING CONTAINS INFORMATION THAT IS PROPRIETARY TO MOLEX ELECTRONIC TECHNOLOGIES, LLC AND SHOULD NOT BE USED WITHOUT WRITTEN PERMISSION																													
DIMENSION UNITS					SCALE					CURRENT REV DESC: REMASTERED IN NX																													
mm					NTS					 CUSTOM HEADER 2.00MM PITCH DUAL ROW HDR, SINGLE WAFER, SMT PRODUCT CUSTOMER DRAWING																													
GENERAL TOLERANCES (UNLESS SPECIFIED)																																							
4 PLACES ±					MM					INCH					EC NO: 614469																								
3 PLACES ±															DRWN: GJEEVANSURES 2019/02/12																								
2 PLACES ± 0.2															CHK'D: GJEEVANSURES 2019/04/10																								
1 PLACE ±															APPR: ISHWARG 2019/04/15																								
0 PLACES ±															INITIAL REVISION:																								
ANGULAR TOL ± 3.0°															DRWN: SKLIM01 2006/03/23																								
DRAFT WHERE APPLICABLE MUST REMAIN WITHIN DIMENSIONS															APPR: PATEY 2006/03/29																								
THIRD ANGLE PROJECTION					DRAWING					SERIES					DOCUMENT NUMBER																								
A3-SIZE					87759					MATERIAL NUMBER					CUSTOMER																								
SEE TABLE					GENERAL MARKET					SHEET NUMBER					7 OF 12																								
DOCUMENT STATUS										P1										RELEASE DATE										2019/04/15 06:29:54									

10	9	8	7	6	5	4	3	2	1									
PART NUMBER WITHOUT CAP IN TUBE	PART NUMBER WITH CAP IN TUBE	PART NUMBER WITH CAP IN TAPE & REEL	CKT SIZE	PEG	PLATING TYPE	VOID POSITION	A	B	C	M	(F)	(G)	Bo	F1	So	W	EMBOSSED TYPE	
F	87759-6203	87759-7203	87759-8203	20	Y	3	----	19.90	18.00	---	3.20	5.90	8.10	20.50	20.20	40.40	44.00	B
	----	87759-8053	87759-8054	20	N	2	----	19.90	18.00	----	3.80	6.50	8.70	20.20	14.20	28.40	32.00	B
	----	87759-0019	87759-0020	20	Y	1	----	19.90	18.00	16.00	3.20	5.90	8.05	20.50	20.20	40.40	44.00	B
	87759-5801	87759-5802	87759-2058	20	Y	1	----	19.90	18.00	16.00	4.30	7.00	8.31	20.50	14.20	28.40	32.00	B
E	87759-2261	87759-2271	87759-2281	22	N	1	----	21.90	20.00	---	3.20	5.90	8.10	22.50	20.20	40.40	44.00	B
	87759-2262	87759-2272	87759-2282	22	N	2	----	21.90	20.00	---	3.20	5.90	8.10	22.50	20.20	40.40	44.00	B
	87759-2263	87759-2273	87759-2283	22	N	3	----	21.90	20.00	---	3.20	5.90	8.10	22.50	20.20	40.40	44.00	B
	87759-6221	87759-7221	87759-8221	22	Y	1	----	21.90	20.00	---	3.20	5.90	8.10	22.50	20.20	40.40	44.00	B
	87759-6222	87759-7222	87759-8222	22	Y	2	----	21.90	20.00	---	3.20	5.90	8.10	22.50	20.20	40.40	44.00	B
	87759-6223	87759-7223	87759-8223	22	Y	3	----	21.90	20.00	---	3.20	5.90	8.10	22.50	20.20	40.40	44.00	B
D																		
	87759-2461	87759-2471	87759-2481	24	N	1	----	23.90	22.00	---	3.20	5.90	8.10	24.50	20.20	40.40	44.00	B
	87759-2462	87759-2472	87759-2482	24	N	2	----	23.90	22.00	---	3.20	5.90	8.10	24.50	20.20	40.40	44.00	B
	87759-2463	87759-2473	87759-2483	24	N	3	----	23.90	22.00	---	3.20	5.90	8.10	24.50	20.20	40.40	44.00	B
	87759-6241	87759-7241	87759-8241	24	Y	1	----	23.90	22.00	---	3.20	5.90	8.10	24.50	20.20	40.40	44.00	B
	87759-6242	87759-7242	87759-8242	24	Y	2	----	23.90	22.00	---	3.20	5.90	8.10	24.50	20.20	40.40	44.00	B
C	87759-6243	87759-7243	87759-8243	24	Y	3	----	23.90	22.00	---	3.20	5.90	8.10	24.50	20.20	40.40	44.00	B
	87759-2661	87759-2671	87759-2681	26	N	1	----	25.90	24.00	---	3.20	5.90	8.10	26.50	20.20	40.40	44.00	B
	87759-2662	87759-2672	87759-2682	26	N	2	----	25.90	24.00	---	3.20	5.90	8.10	26.50	20.20	40.40	44.00	B
	87759-2663	87759-2673	87759-2683	26	N	3	----	25.90	24.00	---	3.20	5.90	8.10	26.50	20.20	40.40	44.00	B
	87759-6261	87759-7261	87759-8261	26	Y	1	----	25.90	24.00	---	3.20	5.90	8.10	26.50	20.20	40.40	44.00	B
	87759-6262	87759-7262	87759-8262	26	Y	2	----	25.90	24.00	---	3.20	5.90	8.10	26.50	20.20	40.40	44.00	B
	87759-6263	87759-7263	87759-8263	26	Y	3	----	25.90	24.00	---	3.20	5.90	8.10	26.50	20.20	40.40	44.00	B

THIS DRAWING CONTAINS INFORMATION THAT IS PROPRIETARY TO MOLEX ELECTRONIC TECHNOLOGIES, LLC AND SHOULD NOT BE USED WITHOUT WRITTEN PERMISSION

SYMBOLS		SCALE		CURRENT REV DESC: REMASTERED IN NX	
▽ = 0	mm	NTS		molex CUSTOM HEADER 2.00MM PITCH DUAL ROW HDR, SINGLE WAFER, SMT PRODUCT CUSTOMER DRAWING	
GENERAL TOLERANCES (UNLESS SPECIFIED)					
▽ = 0	4 PLACES ±	MM	INCH		
▽ = 0	3 PLACES ±				
▽ = 0	2 PLACES ± 0.2				
▽ = 0	1 PLACE ±			EC NO: 614469 DRWN: GJEEVANSURES 2019/02/12 CHK'D: GJEEVANSURES 2019/04/10 APPR: ISHWARG 2019/04/15	
▽ = 0	0 PLACES ±			INITIAL REVISION: DRWN: SKLIM01 2006/03/23 APPR: PATEY 2006/03/29	
☒ = 0	ANGULAR TOL ± 3.0°		DOCUMENT NUMBER: SD-87759-277 DOC TYPE: PSD DOC PART: 001 REVISION: B3		
■ = 0	DRAFT WHERE APPLICABLE MUST REMAIN WITHIN DIMENSIONS		THIRD ANGLE PROJECTION	DRAWING: A3-SIZE	SERIES: 87759
▽ = 0			MATERIAL NUMBER: SEE TABLE	CUSTOMER: GENERAL MARKET	SHEET NUMBER: 8 OF 12

DOCUMENT STATUS | P1 | RELEASE DATE | 2019/04/15 06:29:54

10	9	8	7	6	5	4	3	2	1									
PART NUMBER WITHOUT CAP IN TUBE	PART NUMBER WITH CAP IN TUBE	PART NUMBER WITH CAP IN TAPE & REEL	CKT SIZE	PEG	PLATING TYPE	VOID POSITION	A	B	C	M	(F)	(G)	Bo	F1	So	W	EMBOSSED TYPE	
F	87759-2861	87759-2871	87759-2881	28	N	1	----	27.90	26.00	---	3.20	5.90	8.10	28.50	20.20	40.40	44.00	B
	87759-2862	87759-2872	87759-2882	28	N	2	----	27.90	26.00	---	3.20	5.90	8.10	28.50	20.20	40.40	44.00	B
	87759-2863	87759-2873	87759-2883	28	N	3	----	27.90	26.00	---	3.20	5.90	8.10	28.50	20.20	40.40	44.00	B
	87759-6281	87759-7281	87759-8281	28	Y	1	----	27.90	26.00	---	3.20	5.90	8.10	28.50	20.20	40.40	44.00	B
	87759-6282	87759-7282	87759-8282	28	Y	2	----	27.90	26.00	---	3.20	5.90	8.10	28.50	20.20	40.40	44.00	B
E	87759-6283	87759-7283	87759-8283	28	Y	3	----	27.90	26.00	---	3.20	5.90	8.10	28.50	20.20	40.40	44.00	B
	87759-3061	87759-3071	87759-3081	30	N	1	----	29.90	28.00	---	3.20	5.90	8.10	30.50	20.20	40.40	44.00	B
	87759-3062	87759-3072	87759-3082	30	N	2	----	29.90	28.00	---	3.20	5.90	8.10	30.50	20.20	40.40	44.00	B
	87759-3063	87759-3073	87759-3083	30	N	3	----	29.90	28.00	---	3.20	5.90	8.10	30.50	20.20	40.40	44.00	B
	87759-6301	87759-7301	87759-8301	30	Y	1	----	29.90	28.00	---	3.20	5.90	8.10	30.50	20.20	40.40	44.00	B
D	87759-6302	87759-7302	87759-8302	30	Y	2	----	29.90	28.00	---	3.20	5.90	8.10	30.50	20.20	40.40	44.00	B
	87759-6303	87759-7303	87759-8303	30	Y	3	----	29.90	28.00	---	3.20	5.90	8.10	30.50	20.20	40.40	44.00	B
	87759-3261	87759-3271	87759-3281	32	N	1	----	31.90	30.00	---	3.20	5.90	8.10	32.50	26.20	52.40	56.00	B
	87759-3262	87759-3272	87759-3282	32	N	2	----	31.90	30.00	---	3.20	5.90	8.10	32.50	26.20	52.40	56.00	B
	87759-3263	87759-3273	87759-3283	32	N	3	----	31.90	30.00	---	3.20	5.90	8.10	32.50	26.20	52.40	56.00	B
C	87759-6321	87759-7321	87759-8321	32	Y	1	----	31.90	30.00	---	3.20	5.90	8.10	32.50	26.20	52.40	56.00	B
	87759-6322	87759-7322	87759-8322	32	Y	2	----	31.90	30.00	---	3.20	5.90	8.10	32.50	26.20	52.40	56.00	B
	87759-6323	87759-7323	87759-8323	32	Y	3	----	31.90	30.00	---	3.20	5.90	8.10	32.50	26.20	52.40	56.00	B
	87759-0009	-----	-----	32	Y	1	----	31.90	30.00	28.00	8.00	10.70	---	----	----	----	----	---
	87759-0010	-----	-----	32	N	1	----	31.90	30.00	28.00	8.00	10.70	---	----	----	----	----	---

B										A																																								
<p>SYMBOLS</p> <p>▽ = 0</p> <p>▽ = 0</p> <p>▽ = 0</p> <p>▽ = 0</p> <p>▽ = 0</p> <p>▽ = 0</p> <p>▽ = 0</p> <p>▽ = 0</p> <p>▽ = 0</p> <p>▽ = 0</p> <p>▽ = 0</p> <p>▽ = 0</p>										<p>THIS DRAWING CONTAINS INFORMATION THAT IS PROPRIETARY TO MOLEX ELECTRONIC TECHNOLOGIES, LLC AND SHOULD NOT BE USED WITHOUT WRITTEN PERMISSION</p> <p>CURRENT REV DESC: REMASTERED IN NX</p> <p>EC NO: 614469</p> <p>DRWN: GJEEVANSURES 2019/02/12</p> <p>CHK'D: GJEEVANSURES 2019/04/10</p> <p>APPR: ISHWARG 2019/04/15</p> <p>INITIAL REVISION:</p> <p>DRWN: SKLIM01 2006/03/23</p> <p>APPR: PATEY 2006/03/29</p> <p>THIRD ANGLE PROJECTION</p> <p>DRAFT WHERE APPLICABLE MUST REMAIN WITHIN DIMENSIONS</p>										<p>SCALE</p> <p>mm NTS</p> <p>GENERAL TOLERANCES (UNLESS SPECIFIED)</p> <table border="1"> <tr> <th></th> <th>MM</th> <th>INCH</th> </tr> <tr> <td>4 PLACES</td> <td>±</td> <td>±</td> </tr> <tr> <td>3 PLACES</td> <td>±</td> <td>±</td> </tr> <tr> <td>2 PLACES</td> <td>± 0.2</td> <td>±</td> </tr> <tr> <td>1 PLACE</td> <td>±</td> <td>±</td> </tr> <tr> <td>0 PLACES</td> <td>±</td> <td>±</td> </tr> <tr> <td>ANGULAR TOL</td> <td colspan="2">± 3.0°</td> </tr> </table> <p>DOCUMENT NUMBER: SD-87759-277</p> <p>DOC TYPE: PSD</p> <p>DOC PART: 001</p> <p>REVISION: B3</p> <p>MATERIAL NUMBER: SEE TABLE</p> <p>CUSTOMER: GENERAL MARKET</p> <p>SHEET NUMBER: 9 OF 12</p>											MM	INCH	4 PLACES	±	±	3 PLACES	±	±	2 PLACES	± 0.2	±	1 PLACE	±	±	0 PLACES	±	±	ANGULAR TOL	± 3.0°	
	MM	INCH																																																
4 PLACES	±	±																																																
3 PLACES	±	±																																																
2 PLACES	± 0.2	±																																																
1 PLACE	±	±																																																
0 PLACES	±	±																																																
ANGULAR TOL	± 3.0°																																																	
<p>DOCUMENT STATUS: P1</p> <p>RELEASE DATE: 2019/04/15 06:29:54</p>										<p>FORMAT: Mfg</p> <p>REVISION: D</p> <p>DATE: 2018/01/11</p>																																								

10	9	8	7	6	5	4	3	2	1									
PART NUMBER WITHOUT CAP IN TUBE	PART NUMBER WITH CAP IN TUBE	PART NUMBER WITH CAP IN TAPE & REEL	CKT SIZE	PEG	PLATING TYPE	VOID POSITION	A	B	C	M	(F)	(G)	Bo	F1	So	W	EMBOSSED TYPE	
F	87759-3461	87759-3471	87759-3481	34	N	1	----	33.90	32.00	---	3.20	5.90	8.10	34.50	26.20	52.40	56.00	B
	87759-3462	87759-3472	87759-3482	34	N	2	----	33.90	32.00	---	3.20	5.90	8.10	34.50	26.20	52.40	56.00	B
	87759-3463	87759-3473	87759-3483	34	N	3	----	33.90	32.00	---	3.20	5.90	8.10	34.50	26.20	52.40	56.00	B
	87759-6341	87759-7341	87759-8341	34	Y	1	----	33.90	32.00	---	3.20	5.90	8.10	34.50	26.20	52.40	56.00	B
	87759-6342	87759-7342	87759-8342	34	Y	2	----	33.90	32.00	---	3.20	5.90	8.10	34.50	26.20	52.40	56.00	B
E	87759-6343	87759-7343	87759-8343	34	Y	3	----	33.90	32.00	---	3.20	5.90	8.10	34.50	26.20	52.40	56.00	B
	87759-3661	87759-3671	87759-3681	36	N	1	----	35.90	34.00	---	3.20	5.90	8.10	36.50	26.20	52.40	56.00	B
	87759-3662	87759-3672	87759-3682	36	N	2	----	35.90	34.00	---	3.20	5.90	8.10	36.50	26.20	52.40	56.00	B
	87759-3663	87759-3673	87759-3683	36	N	3	----	35.90	34.00	---	3.20	5.90	8.10	36.50	26.20	52.40	56.00	B
	87759-6361	87759-7361	87759-8361	36	Y	1	----	35.90	34.00	---	3.20	5.90	8.10	36.50	26.20	52.40	56.00	B
D	87759-6362	87759-7362	87759-8362	36	Y	2	----	35.90	34.00	---	3.20	5.90	8.10	36.50	26.20	52.40	56.00	B
	87759-6363	87759-7363	87759-8363	36	Y	3	----	35.90	34.00	---	3.20	5.90	8.10	36.50	26.20	52.40	56.00	B
	87759-0014	----	----	36	N	1	----	35.90	34.00	---	9.50	12.20	---	---	---	---	---	---
	87759-3861	87759-3871	87759-3881	38	N	1	----	37.90	36.00	---	3.20	5.90	8.10	38.50	26.20	52.40	56.00	B
	87759-3862	87759-3872	87759-3882	38	N	2	----	37.90	36.00	---	3.20	5.90	8.10	38.50	26.20	52.40	56.00	B
C	87759-3863	87759-3873	87759-3883	38	N	3	----	37.90	36.00	---	3.20	5.90	8.10	38.50	26.20	52.40	56.00	B
	87759-6381	87759-7381	87759-8381	38	Y	1	----	37.90	36.00	---	3.20	5.90	8.10	38.50	26.20	52.40	56.00	B
	87759-6382	87759-7382	87759-8382	38	Y	2	----	37.90	36.00	---	3.20	5.90	8.10	38.50	26.20	52.40	56.00	B
	87759-6383	87759-7383	87759-8383	38	Y	3	----	37.90	36.00	---	3.20	5.90	8.10	38.50	26.20	52.40	56.00	B

B										A																																																									
<p>DOCUMENT STATUS P1 RELEASE DATE 2019/04/15 06:29:54</p>										<table border="1"> <tr> <td colspan="2">SYMBOLS</td> <td colspan="2">THIS DRAWING CONTAINS INFORMATION THAT IS PROPRIETARY TO MOLEX ELECTRONIC TECHNOLOGIES, LLC AND SHOULD NOT BE USED WITHOUT WRITTEN PERMISSION</td> </tr> <tr> <td>▽ = 0</td> <td>mm</td> <td>SCALE</td> <td>NTS</td> </tr> <tr> <td>▽ = 0</td> <td colspan="2">GENERAL TOLERANCES (UNLESS SPECIFIED)</td> <td rowspan="5">CURRENT REV DESC: REMASTERED IN NX</td> </tr> <tr> <td>▽ = 0</td> <td>MM</td> <td>INCH</td> </tr> <tr> <td>▽ = 0</td> <td>4 PLACES ±</td> <td>±</td> </tr> <tr> <td>▽ = 0</td> <td>3 PLACES ±</td> <td>±</td> </tr> <tr> <td>▽ = 0</td> <td>2 PLACES ±</td> <td>0.2 ±</td> </tr> <tr> <td>▽ = 0</td> <td>1 PLACE ±</td> <td>±</td> <td>EC NO: 614469</td> </tr> <tr> <td>☒ = 0</td> <td>0 PLACES ±</td> <td>±</td> <td>DRWN: GJEEVANSURES 2019/02/12</td> </tr> <tr> <td>■ = 0</td> <td>ANGULAR TOL ±</td> <td>3.0°</td> <td>CHK'D: GJEEVANSURES 2019/04/10</td> </tr> <tr> <td>▽ = 0</td> <td colspan="2">DRAFT WHERE APPLICABLE MUST REMAIN WITHIN DIMENSIONS</td> <td>APPR: ISHWARG 2019/04/15</td> </tr> <tr> <td colspan="2">THIRD ANGLE PROJECTION</td> <td>DRAWING</td> <td>SERIES</td> </tr> <tr> <td colspan="2"></td> <td>A3-SIZE</td> <td>87759</td> </tr> </table>										SYMBOLS		THIS DRAWING CONTAINS INFORMATION THAT IS PROPRIETARY TO MOLEX ELECTRONIC TECHNOLOGIES, LLC AND SHOULD NOT BE USED WITHOUT WRITTEN PERMISSION		▽ = 0	mm	SCALE	NTS	▽ = 0	GENERAL TOLERANCES (UNLESS SPECIFIED)		CURRENT REV DESC: REMASTERED IN NX	▽ = 0	MM	INCH	▽ = 0	4 PLACES ±	±	▽ = 0	3 PLACES ±	±	▽ = 0	2 PLACES ±	0.2 ±	▽ = 0	1 PLACE ±	±	EC NO: 614469	☒ = 0	0 PLACES ±	±	DRWN: GJEEVANSURES 2019/02/12	■ = 0	ANGULAR TOL ±	3.0°	CHK'D: GJEEVANSURES 2019/04/10	▽ = 0	DRAFT WHERE APPLICABLE MUST REMAIN WITHIN DIMENSIONS		APPR: ISHWARG 2019/04/15	THIRD ANGLE PROJECTION		DRAWING	SERIES			A3-SIZE	87759
SYMBOLS		THIS DRAWING CONTAINS INFORMATION THAT IS PROPRIETARY TO MOLEX ELECTRONIC TECHNOLOGIES, LLC AND SHOULD NOT BE USED WITHOUT WRITTEN PERMISSION																																																																	
▽ = 0	mm	SCALE	NTS																																																																
▽ = 0	GENERAL TOLERANCES (UNLESS SPECIFIED)		CURRENT REV DESC: REMASTERED IN NX																																																																
▽ = 0	MM	INCH																																																																	
▽ = 0	4 PLACES ±	±																																																																	
▽ = 0	3 PLACES ±	±																																																																	
▽ = 0	2 PLACES ±	0.2 ±																																																																	
▽ = 0	1 PLACE ±	±	EC NO: 614469																																																																
☒ = 0	0 PLACES ±	±	DRWN: GJEEVANSURES 2019/02/12																																																																
■ = 0	ANGULAR TOL ±	3.0°	CHK'D: GJEEVANSURES 2019/04/10																																																																
▽ = 0	DRAFT WHERE APPLICABLE MUST REMAIN WITHIN DIMENSIONS		APPR: ISHWARG 2019/04/15																																																																
THIRD ANGLE PROJECTION		DRAWING	SERIES																																																																
		A3-SIZE	87759																																																																
<p>DOCUMENT NUMBER: SD-87759-277</p>										<p>DOC TYPE: PSD DOC PART: 001 REVISION: B3</p>																																																									
<p>MATERIAL NUMBER: SEE TABLE</p>										<p>CUSTOMER: GENERAL MARKET</p>																																																									
<p>SHEET NUMBER: 10 OF 12</p>										<p>INITIAL REVISION: DRWN: SKLIM01 2006/03/23 APPR: PATEY 2006/03/29</p>																																																									
<p>PRODUCT CUSTOMER DRAWING</p>										<p>2.00MM PITCH DUAL ROW HDR, SINGLE WAFER, SMT</p>																																																									
<p>moLEX</p>										<p>CUSTOM HEADER</p>																																																									

10	9	8	7	6	5	4	3	2	1										
PART NUMBER WITHOUT CAP IN TUBE	PART NUMBER WITH CAP IN TUBE	PART NUMBER WITH CAP IN TAPE & REEL	PART NUMBER WITHOUT CAP IN TAPE & REEL	CKT SIZE	PEG	PLATING TYPE	VOID POSITION	A	B	C	M	(F)	(G)	Bo	F1	So	W	EMBOSSED TYPE	
F	87759-4061	87759-4071	87759-4081	-----	40	N	1	----	39.90	38.00	---	3.20	5.90	8.10	40.50	26.20	52.40	56.00	B
	87759-4062	87759-4072	87759-4082	-----	40	N	2	----	39.90	38.00	---	3.20	5.90	8.10	40.50	26.20	52.40	56.00	B
	87759-4063	87759-4073	87759-4083	-----	40	N	3	----	39.90	38.00	---	3.20	5.90	8.10	40.50	26.20	52.40	56.00	B
	87759-6401	87759-7401	87759-8401	-----	40	Y	1	----	39.90	38.00	---	3.20	5.90	8.10	40.50	26.20	52.40	56.00	B
	87759-6402	87759-7402	87759-8402	-----	40	Y	2	----	39.90	38.00	---	3.20	5.90	8.10	40.50	26.20	52.40	56.00	B
E	87759-6403	87759-7403	87759-8403	-----	40	Y	3	----	39.90	38.00	---	3.20	5.90	8.10	40.50	26.20	52.40	56.00	B
	87759-0010	----	-----	-----	40	N	1	----	39.90	38.00	---	8.00	10.70	---	---	---	---	----	---
	87759-0011	-----	-----	-----	40	Y	1	----	39.90	38.00	36.00	8.00	10.70	----	---	---	---	---	---
	-----	-----	-----	-----	40	N	4	----	39.90	38.00	----	8.40	11.10	12.47	40.50	26.20	52.40	56.00	B
	87759-4014	-----	-----	87759-0484	40	N	1	----	39.90	38.00	----	3.80	6.50	---	40.20	26.20	52.40	56.00	B
	87759-4015	-----	-----	87759-4065	40	N	2	----	39.90	38.00	----	3.80	6.50	----	40.20	26.20	52.40	58.00	B
D																			
	87759-4261	87759-4271	87759-4281	-----	42	N	1	----	41.90	40.00	---	3.20	5.90	8.10	42.50	26.20	52.40	56.00	B
	87759-4262	87759-4272	87759-4282	-----	42	N	2	----	41.90	40.00	---	3.20	5.90	8.10	42.50	26.20	52.40	56.00	B
	87759-4263	87759-4273	87759-4283	-----	42	N	3	----	41.90	40.00	---	3.20	5.90	8.10	42.50	26.20	52.40	56.00	B
	87759-6421	87759-7421	87759-8421	-----	42	Y	1	----	41.90	40.00	---	3.20	5.90	8.10	42.50	26.20	52.40	56.00	B
	87759-6422	87759-7422	87759-8422	-----	42	Y	2	----	41.90	40.00	---	3.20	5.90	8.10	42.50	26.20	52.40	56.00	B
C	87759-6423	87759-7423	87759-8423	-----	42	Y	3	----	41.90	40.00	---	3.20	5.90	8.10	42.50	26.20	52.40	56.00	B
	87759-4461	87759-4471	87759-4481	-----	44	N	1	----	43.90	42.00	---	3.20	5.90	8.10	44.50	26.20	52.40	56.00	B
	87759-4462	87759-4472	87759-4482	-----	44	N	2	----	43.90	42.00	---	3.20	5.90	8.10	44.50	26.20	52.40	56.00	B
	87759-4463	87759-4473	87759-4483	-----	44	N	3	----	43.90	42.00	---	3.20	5.90	8.10	44.50	26.20	52.40	56.00	B
B	87759-6441	87759-7441	87759-8441	-----	44	Y	1	----	43.90	42.00	---	3.20	5.90	8.10	44.50	26.20	52.40	56.00	B
	87759-6442	87759-7442	87759-8442	-----	44	Y	2	----	43.90	42.00	---	3.20	5.90	8.10	44.50	26.20	52.40	56.00	B
	87759-6443	87759-7443	87759-8443	-----	44	Y	3	----	43.90	42.00	---	3.20	5.90	8.10	44.50	26.20	52.40	56.00	B

SYMBOLS	THIS DRAWING CONTAINS INFORMATION THAT IS PROPRIETARY TO MOLEX ELECTRONIC TECHNOLOGIES, LLC AND SHOULD NOT BE USED WITHOUT WRITTEN PERMISSION											
	DIMENSION UNITS		SCALE		CURRENT REV DESC: REMASTERED IN NX							
	mm		NTS		molex CUSTOM HEADER 2.00MM PITCH DUAL ROW HDR, SINGLE WAFER, SMT							
	GENERAL TOLERANCES (UNLESS SPECIFIED)											
		MM	INCH	EC NO: 614469								
▽ = 0	4 PLACES	±	±	DRWN: GJEEVANSURES 2019/02/12								
▽ = 0	3 PLACES	±	±	CHK'D: GJEEVANSURES 2019/04/10								
▽ = 0	2 PLACES	±	0.2 ±	APPR: ISHWARG 2019/04/15								
▽ = 0	1 PLACE	±	±	INITIAL REVISION:								
☒ = 0	0 PLACES	±	±	DRWN: SKLIM01 2006/03/23		DOCUMENT NUMBER				DOC TYPE	DOC PART	REVISION
■ = 0	ANGULAR TOL ± 3.0°			APPR: PATEY 2006/03/29		SD-87759-277			PSD	001	B3	
▽ = 0	DRAFT WHERE APPLICABLE MUST REMAIN WITHIN DIMENSIONS			THIRD ANGLE PROJECTION		DRAWING	SERIES	MATERIAL NUMBER	CUSTOMER		SHEET NUMBER	
						A3-SIZE	87759	SEE TABLE	GENERAL MARKET		11 OF 12	

10	9	8	7	6	5	4	3	2	1									
PART NUMBER WITHOUT CAP IN TUBE	PART NUMBER WITH CAP IN TUBE	PART NUMBER WITH CAP IN TAPE & REEL	CKT SIZE	PEG	PLATING TYPE	VOID POSITION	A	B	C	M	(F)	(G)	Bo	F1	So	W	EMBOSSSED TYPE	
F	87759-4661	87759-4671	87759-4681	46	N	1	----	45.90	44.00	---	3.20	5.90	8.10	46.50	34.20	68.40	72.00	B
	87759-4662	87759-4672	87759-4682	46	N	2	----	45.90	44.00	---	3.20	5.90	8.10	46.50	34.20	68.40	72.00	B
	87759-4663	87759-4673	87759-4683	46	N	3	----	45.90	44.00	---	3.20	5.90	8.10	46.50	34.20	68.40	72.00	B
	87759-6461	87759-7461	87759-8461	46	Y	1	----	45.90	44.00	---	3.20	5.90	8.10	46.50	34.20	68.40	72.00	B
	87759-6462	87759-7462	87759-8462	46	Y	2	----	45.90	44.00	---	3.20	5.90	8.10	46.50	34.20	68.40	72.00	B
E	87759-6463	87759-7463	87759-8463	46	Y	3	----	45.90	44.00	---	3.20	5.90	8.10	46.50	34.20	68.40	72.00	B
	87759-4861	87759-4871	87759-4881	48	N	1	----	47.90	46.00	---	3.20	5.90	8.10	48.50	34.20	68.40	72.00	B
	87759-4862	87759-4872	87759-4882	48	N	2	----	47.90	46.00	---	3.20	5.90	8.10	48.50	34.20	68.40	72.00	B
	87759-4863	87759-4873	87759-4883	48	N	3	----	47.90	46.00	---	3.20	5.90	8.10	48.50	34.20	68.40	72.00	B
	87759-6481	87759-7481	87759-8481	48	Y	1	----	47.90	46.00	---	3.20	5.90	8.10	48.50	34.20	68.40	72.00	B
D	87759-6482	87759-7482	87759-8482	48	Y	2	----	47.90	46.00	---	3.20	5.90	8.10	48.50	34.20	68.40	72.00	B
	87759-6483	87759-7483	87759-8483	48	Y	3	----	47.90	46.00	---	3.20	5.90	8.10	48.50	34.20	68.40	72.00	B
	87759-5061	87759-5071	87759-5081	50	N	1	----	49.90	48.00	---	3.20	5.90	8.10	50.50	34.20	68.40	72.00	B
	87759-5062	87759-5072	87759-5082	50	N	2	----	49.90	48.00	---	3.20	5.90	8.10	50.50	34.20	68.40	72.00	B
	87759-5063	87759-5073	87759-5083	50	N	3	----	49.90	48.00	---	3.20	5.90	8.10	50.50	34.20	68.40	72.00	B
C	87759-6501	87759-7501	87759-8501	50	Y	1	----	49.90	48.00	---	3.20	5.90	8.10	50.50	34.20	68.40	72.00	B
	87759-6502	87759-7502	87759-8502	50	Y	2	----	49.90	48.00	---	3.20	5.90	8.10	50.50	34.20	68.40	72.00	B
	87759-6503	87759-7503	87759-8503	50	Y	3	----	49.90	48.00	---	3.20	5.90	8.10	50.50	34.20	68.40	72.00	B

B										B									
A										A									

SYMBOLS										THIS DRAWING CONTAINS INFORMATION THAT IS PROPRIETARY TO MOLEX ELECTRONIC TECHNOLOGIES, LLC AND SHOULD NOT BE USED WITHOUT WRITTEN PERMISSION									
DIMENSION UNITS					SCALE					CURRENT REV DESC: REMASTERED IN NX									
mm					NTS					<p>molex</p> <p>CUSTOM HEADER</p> <p>2.00MM PITCH DUAL ROW HDR, SINGLE WAFER, SMT</p> <p>PRODUCT CUSTOMER DRAWING</p>									
GENERAL TOLERANCES (UNLESS SPECIFIED)																			
4 PLACES ±					MM					INCH					EC NO: 614469				
3 PLACES ±															DRWN: GJEEVANSURES 2019/02/12				
2 PLACES ±					0.2										CHK'D: GJEEVANSURES 2019/04/10				
1 PLACE ±															APPR: ISHWARG 2019/04/15				
0 PLACES ±															INITIAL REVISION:				
ANGULAR TOL ± 3.0°															DRWN: SKLIM01 2006/03/23				
DRAFT WHERE APPLICABLE MUST REMAIN WITHIN DIMENSIONS					THIRD ANGLE PROJECTION					DRAWING					SERIES				
					A3-SIZE					87759					MATERIAL NUMBER				
					SEE TABLE					GENERAL MARKET					SHEET NUMBER				
															SD-87759-277 PSD 001 B3				

DOCUMENT STATUS	P1	RELEASE DATE	2019/04/15	06:29:54
-----------------	----	--------------	------------	----------