

13 12 11 10 9 8 7 6 5 4 3 2 1

NO. OF CIRCUITS	DIM. "A"		DIM. "B"		ASSEMBLY MATERIAL NO. (STANDARD)	ASSEMBLY MATERIAL NO. (-49 OPT)	ASSEMBLY MATERIAL NO. (-10A OPT)	MATERIAL NO. WITH CAGES CLOSED (SEE NOTE 10)	FRONT TERMINAL QTY.	REAR TERMINAL QTY.
	mm	in	mm	in						
03	24.8	0.98	16.00	0.630	399500103	399540103	399520103	399590007	1	2
04	32.8	1.29	24.00	0.945	399500104	399540104	399520104		2	2
05	40.8	1.61	32.00	1.260	399500105	399540105	399520105		2	3
06	48.8	1.92	40.00	1.575	399500106	399540106	399520106		3	3
07	56.8	2.24	48.00	1.890	399500107	399540107	399520107		3	4
08	64.8	2.55	56.00	2.205	399500108	399540108	399520108		4	4
09	72.8	2.87	64.00	2.520	399500109	399540109	399520109		4	5
10	80.8	3.18	72.00	2.835	399500110	399540110	399520110		5	5
11	88.8	3.50	80.00	3.150	399500111	399540111	399520111		5	6
12	96.8	3.81	88.00	3.465	399500112	399540112	399520112		6	6
13	104.8	4.13	96.00	3.780	399500113	399540113	399520113		6	7
14	112.8	4.44	104.00	4.094	399500114	399540114	399520114		7	7
15	120.8	4.76	112.00	4.409	399500115	399540115	399520115		7	8
16	128.8	5.07	120.00	4.724	399500116	399540116	399520116		8	8

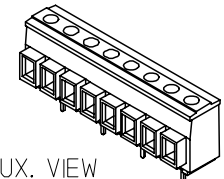

AUX. VIEW SCALE 1:1

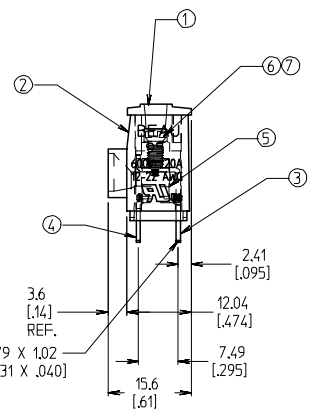
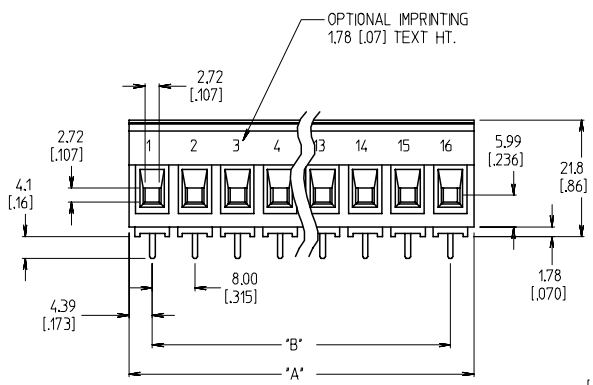
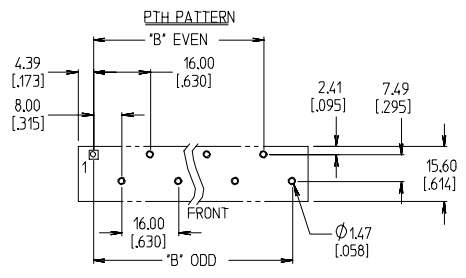
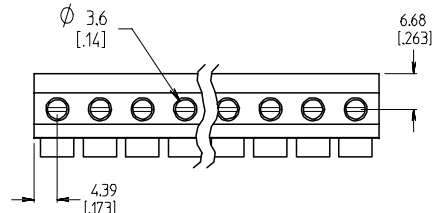

NOTES:

1. MATERIAL: SEE TABLE
2. FINISHES: SEE TABLE
3. INCH DMS ARE SHOWN IN BRACKETS [XXX].
4. "XX" REFER TO THE NUMBER OF CIRCUITS.
5. ALL CREEP DISTANCES FOR UL 1059, CLASS C, 600V GENERAL INDUSTRIAL.
6. FOR USE WITH #22-#12 AWG SOLID AND STRANDED WIRES
7. TORQUE RATING IS 5 IN-LB, MAX.
8. PRODUCT PERFORMANCE SPECIFICATION PPS.95.001
9. ASSEMBLY IS ROHS COMPLIANT.
10. THIS ASSEMBLY USES ITEM 6 SCREW AND IS SHIPPED WITH SCREWS DRIVEN DOWN FULLY TO CLOSE THE CAGE CLAMPS.

ITEM	QTY.	DESCRIPTION	MATERIAL	FINISH
7	"XX"	SCREW, M3 X 0.5, -49 OPTION	PHOS. BRONZE	TN PLATE
6	"XX"	SCREW, M3 X 0.5, STD.	STEEL	ZN, CLEAR CHROMATE
5	"XX"	CAGE CLAMP	BRASS	NICKEL PLATE
4	SEE CHART	FRONT TERMINAL	RED BRASS	TIN PLATE
3	SEE CHART	REAR TERMINAL	RED BRASS	TIN PLATE
2	1	BODY	PBT	BLACK
1	1	CAP	PBT	BLACK

ADD MATERIAL NO. EC NO: ETC2007-0218 DRW: NCLYORK 2006/12/01 CHKD: IMACNEIL 2006/12/04 APPR: IMACNEIL 2006/12/06	QUALITY SYMBOLS
	$\nabla=0$ $\nabla=0$
	DESCRIPTION
	REV

GENERAL TOLERANCES (UNLESS SPECIFIED)	
	mm INCH
4 PLACES ± .005	± .0005
3 PLACES ± .010	± .0010
2 PLACES ± 0.13	± .01
1 PLACE ± 0.3	± .03
ANGULAR ± 2 °	

DIMENSION STYLE	
MM/IN	
DRAWN BY	DATE
GHR	1998/10/30
CHECKED BY	DATE
K. ATKINS	1998/11/02
APPROVED BY	DATE
L. ROTHHAUS	1998/11/02
MATERIAL NO.	
SEE CHART	

SCALE 3:2	DESIGN UNITS INCH	THIRD ANGLE PROJECTION
8.00MM SR BTS, PKCT, #12 AWG ASY, 600V, 20A		
MOLEX INCORPORATED		
DOCUMENT NO. SD-39950-001	SHEET NO. 1 OF 1	
THIS DRAWING CONTAINS INFORMATION THAT IS PROPRIETARY TO MOLEX INCORPORATED AND SHOULD NOT BE USED WITHOUT WRITTEN PERMISSION		