

Connector Solutions M23 Elite Series

STEP 1 Choose Plug

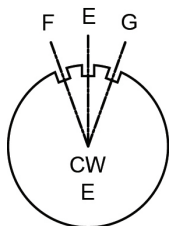

Standard connector parts mate "E" Plugs with "P" Receptacles, Mating parts use opposite contact types. *example: plug with pin contacts mates with a receptacle using socket contacts.*

Other key code options available not listed here. Please call customer service for assistance when ordering F,G,R,S. See page 12 for connector configurations

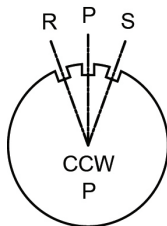

STEP 2 Choose Receptacle

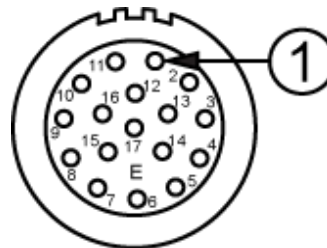

Plugs



Receptacles



Receptacle Kits



Plug Kits

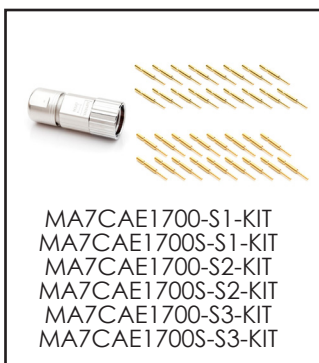

**BULK CABLE starts
on page 23**

SEE TABLE ON NEXT PAGE FOR PART DETAILS

Cord Grips (Required only for Receptacle Extension)



Part Number	Type	Cable Range (mm)	Figure Drawings
MA6CG-S1	Cord grip	4.5-7.5mm	6
MA6CG-S2	Cord grip	7.5-11.0mm	6
MA6CG-S3	Cord grip	11.0-15.0mm	6

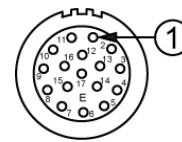

17 POSITIONS
9A / 125V
E type
Threaded

Style: E type Plug **Number of Contacts: 17** **Contact Size: 1.0mm**
 Sealing: IP66/67 AWG: 22-18 (0.37 - 0.75 mm²) / 28-24 (0.25 - 0.10 mm²)

Connector Part Numbers

Part Number	Connector Type PLUGS	Style	Contact Type male = pin mates with female = socket ↓Mating Parts↓		Figure Drawings
MA7CAE1700-S1	Plug, straight, threaded 4.5-7.5mm cord grip	E	Pin	Socket	1
MA7CAE1700-S1-KIT	Plug kit, straight, threaded 4.5-7.5mm cord grip	E	Pin		1
MA7CAE1700S-S1-KIT	Plug kit, straight, threaded 4.5-7.5mm cord grip	E		Socket	1
MA7CAE1700-S2	Plug, straight, threaded 7.5-11mm cord grip	E	Pin	Socket	1
MA7CAE1700-S2-KIT	Plug kit, straight, threaded 7.5-11mm cord grip	E	Pin		1
MA7CAE1700S-S2-KIT	Plug kit, straight, threaded 7.5-11mm cord grip	E		Socket	1
MA7CAE1700-S3	Plug, straight, threaded 11-15mm cord grip	E	Pin	Socket	1
MA7CAE1700-S3-KIT	Plug kit, straight, threaded 11-15mm cord grip	E	Pin	Socket	1
MA7CAE1700S-S3-KIT	Plug kit, straight, threaded 11-15mm cord grip	E		Socket	1
RECEPTACLES			↑ Mating Parts ↓		
MA7RAP1701	Receptacle, 90° rotatable, threaded Standard Flange (25.7x25.7)	P	Socket	Pin	2
MA7RAP1701-KIT	Receptacle Kit, 90° rotatable, threaded Standard Flange (25.7x25.7)	P		Pin	2
MA7RAP1701S-KIT	Receptacle Kit, 90° rotatable, threaded Standard Flange (25.7x25.7)	P	Socket		2
MA7RAP1702	Receptacle, 90° rotatable, threaded Large Flange (28.0x28.0)	P	Socket	Pin	3
MA7RAP1702-KIT	Receptacle Kit, 90° rotatable, threaded Large Flange (28.0x28.0)	P		Pin	3
MA7RAP1702S-KIT	Receptacle Kit, 90° rotatable, threaded Large Flange (28.0x28.0)	P	Socket		3
MA1LAP1700*	Receptacle, straight, flange mount, threaded	P	Socket	Pin	4

*Standard Series receptacles are offered here as additional options for mating with Elite Series plugs.
 See Assembly Instructions starting on page 266

Complete datasheets can be found at www.amphenol-sine.com

Style: E type Plug Number of Contacts: 17 Contact Size: 1.0mm
 Sealing: IP66/67 AWG: 22-18 (0.37 - 0.75 mm²) / 28-24 (0.25 -0.10 mm²)

Connector Part Numbers continued

MA1LAP1700-KIT*	Receptacle kit, straight, threaded. Kit includes contacts.	P		Pin	4
MA1LAP1700S-KIT*	Receptacle kit, straight, threaded. Kit includes contacts.	P	Socket		4
MA1JAP1700*	Receptacle extension, threaded	P	Socket	Pin	5
↑ Contacts supplied separately see Chart					



CHART 1

Crimp Contacts, Machined

Part Number	Pin/Socket	AWG	mm ²	Plating
SC000035	Pin	22-18	0.37 - 0.75	Gold
SC000146	Pin	28-24	0.10 - 0.25	Gold
SC000044	Socket	22-18	0.37 - 0.75	Gold
SC000030	Socket	28-24	0.10 - 0.25	Gold

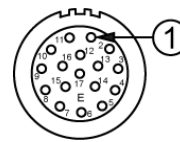

17 POSITIONS
9A / 125V
E type
Threaded

Style: E type Plug Number of Contacts: 17 Contact Size: 1.0mm
Sealing: IP66/67 AWG: 22-18 (0.37 - 0.75 mm²) / 28-24 (0.25 - 0.10 mm²)

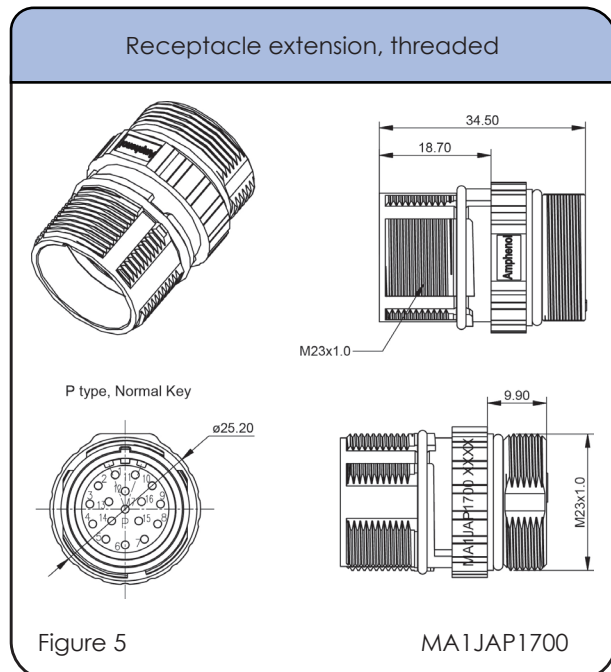
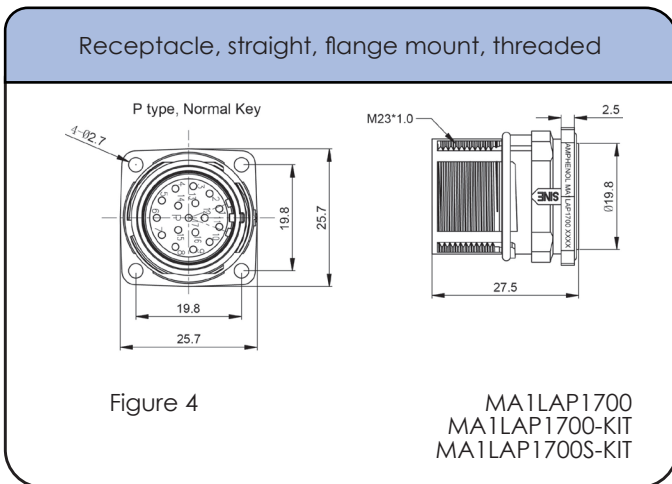
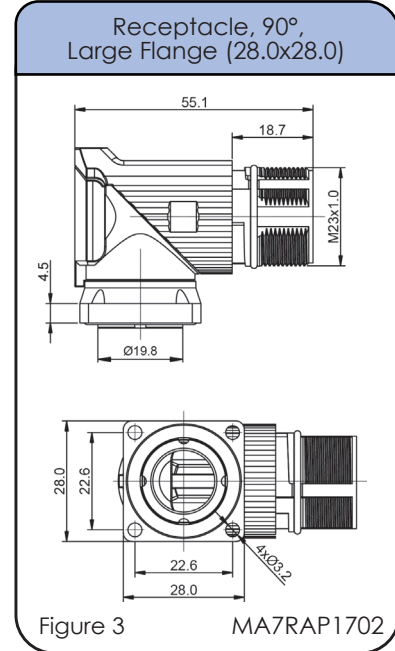
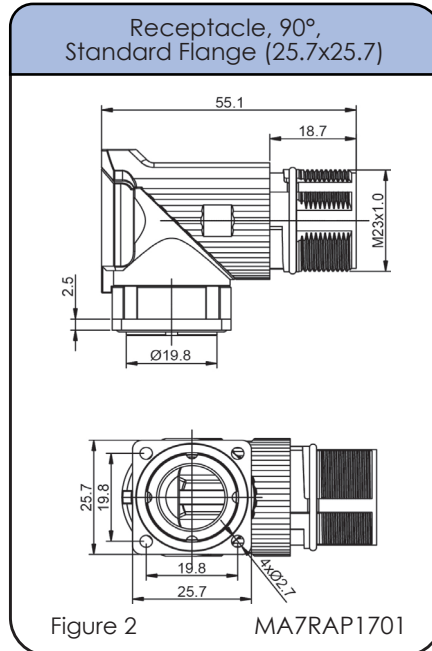
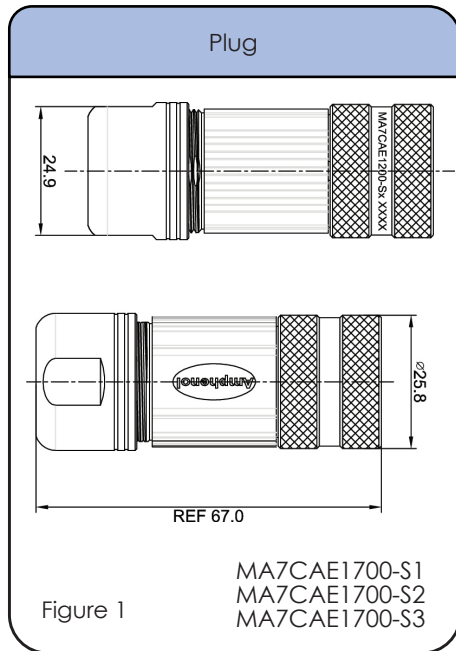

Complete datasheets can be found at www.amphenol-sine.com

Style: E type Plug **Number of Contacts: 17** **Contact Size: 1.0mm**
Sealing: IP66/67 AWG: 22-18 (0.37 - 0.75 mm²) / 28-24 (0.25 - 0.10 mm²)

Connector Drawings continued

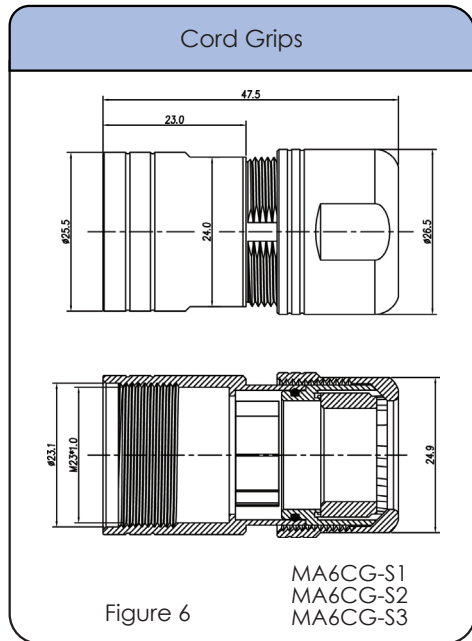

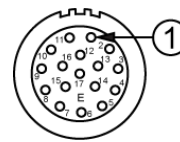









17 POSITIONS
9A / 125V
E type
Threaded

Style: E type Plug Number of Contacts: 17 Contact Size: 1.0mm
 Sealing: IP66/67 AWG: 22-18 (0.37 - 0.75 mm²) / 28-24 (0.25 - 0.10 mm²)

Tools & Accessories

<p>Universal hand crimp tool. Uses universal positioner part no. SK2-2* Wire range 20-32AWG</p>  <p>AFM8</p>	<p>Universal hand crimp tool. Uses universal positioner part no. UH2-5* Wire range 12-26AWG</p>  <p>AF8</p>	<p>Pneumatic crimp tool. Uses universal positioner part no. SK2-2* Wire range 20-32AWG</p>  <p>WA22</p>
<p>Universal positioner is used with crimp tools AFM8 and WA22. Wire range 20-32AWG</p>  <p>SK2-2</p>	<p>Universal positioner is used with the universal hand crimp tool (AF8). Wire range 12-26AWG</p>  <p>UH2-5</p>	<p>Pneumatic crimp tool. Uses universal positioner part no. UH2-5*. Wire range 12-26AWG</p>  <p>WA27F</p>
<p>Extraction tool. Used for removal of 1.0mm contacts from inserts.</p>  <p>50-54931-1</p>	<p>Dust Cap for Receptacle</p>  <p>P29687</p>	<p>Dust Cap for Plug, Threaded</p>  <p>P31660</p>

* The universal positioner is not included with the crimp tools and must be ordered separately.