

CUSTOMER PRINT

PART NUMBER: 8380-XSG-5XX

- NOTES:  
 1. ALL PARTS TO BE BULK PACKED  
 2. CONTACTS ARE SHIPPED UNASSEMBLED  
 3. ALL DIMENSIONS ARE REFERENCE EXCEPT THOSE WITH A TOLERANCE

KIT P/N	GROMMET SIZE
8380-XSG-513	.148 GROMMET I.D. FOR CABLE O.D. .13-.15 [3.3-3.8mm]
8380-XSG-516	.176 GROMMET I.D. FOR CABLE O.D. .16-.18 [4.1-4.6mm]
8380-XSG-519	.206 GROMMET I.D. FOR CABLE O.D. .19-.21 [4.8-5.3mm]
8380-XSG-522	.245 GROMMET I.D. FOR CABLE O.D. .22-.25 [5.6-6.3mm]
8380-XSG-526	.265 GROMMET I.D. FOR CABLE O.D. .25-.27 [6.4-6.9mm]
8380-XSG-528	.280 GROMMET I.D. FOR CABLE O.D. .26-.285 [6.6-7.2mm]

KIT P/N	NO. OF CONTACTS
8380-2SG-5XX	2 #16
8380-3SG-5XX	3 #16
8380-4SG-5XX	4 #16
8380-XSG-5XX	

GROMMET SIZE  
 NO. OF CONTACTS

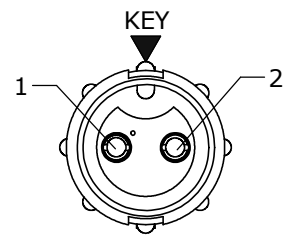

**FACE VIEW**  
8380-2SG-5XX

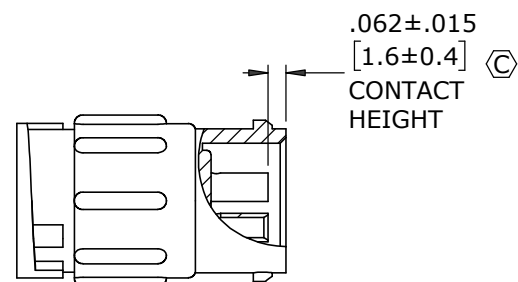

.062±.015  
 [1.6±0.4] CONTACT HEIGHT

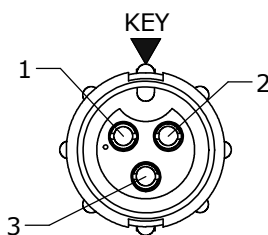

**FACE VIEW**  
8380-3SG-5XX

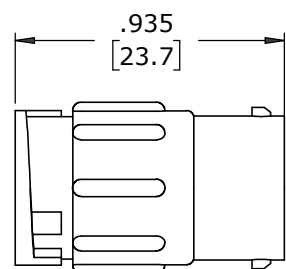

.935 [23.7]  
 IN-LINE CONNECTOR, FEMALE  
 MAT'L: NYLON, BLACK

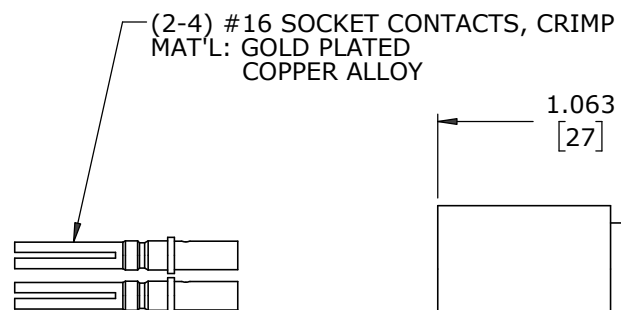

(2-4) #16 SOCKET CONTACTS, CRIMP  
 MAT'L: GOLD PLATED COPPER ALLOY

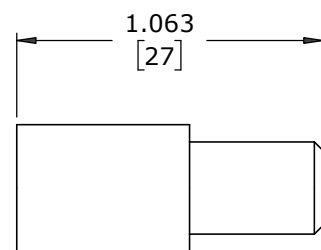

1.063 [27]  
 GROMMET  
 MAT'L: SANTOPRENE, BLACK

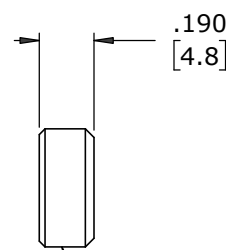

.190 [4.8]  
 CABLE GRIP  
 MAT'L: POLYPROPYLENE, BLACK

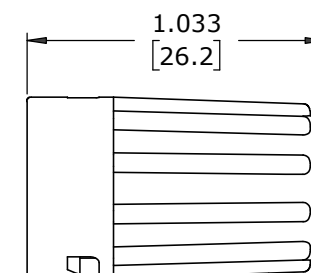

1.033 [26.2]  
 BACKSHELL  
 MAT'L: NYLON, BLACK

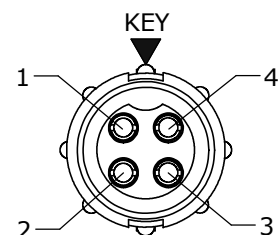

**FACE VIEW**  
8380-4SG-5XX

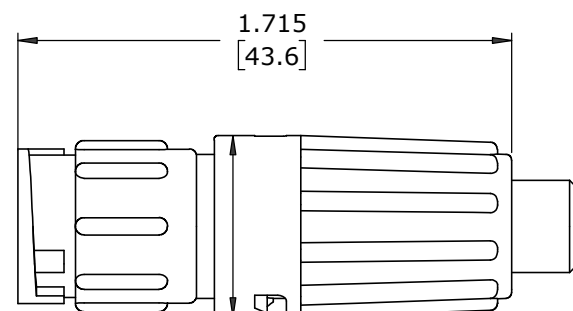

1.715 [43.6]  
 Ø.630 [16]  
**ASSEMBLED VIEW**  
 FOR CUSTOMER REF.

DIMENSIONS IN BRACKETS [ ] ARE IN MILLIMETERS

**CUSTOMER APPROVAL**

THIS DOCUMENT CONTAINS CONFIDENTIAL INFORMATION PROPRIETARY TO CONXALL CORPORATION. ANY REPRODUCTION, DISCLOSURE, OR USE OF THIS DOCUMENT /INFORMATION IS EXPRESSLY PROHIBITED UNLESS AUTHORIZED IN WRITING BY CONXALL CORPORATION.

APPROVED BY: \_\_\_\_\_  
 DATE: \_\_\_\_\_

REV.	INIT.	DATE	DESCRIPTION
C	MA	02-16-21	ADDED 8380-XSG-526 TO CHART & CONTACT HEIGHT VIEW PER ECR 9544
B	PAK	01-14-13	ADDED P/N 8380-XSG-528 FOR .280 CABLE DIA. PER DOR 12-5009TC
A	AN	08-02-12	DRAWING CREATED PER DOR 12-E149SL #20

ALL INFORMATION ILLUSTRATED IS THE PROPERTY OF "CONXALL CORPORATION". UNAUTHORIZED DUPLICATION OR DISTRIBUTION OF THIS DOCUMENT IS PROHIBITED.	ORIG. DRAWN BY: AN DATE: 07-30-12	
ALL UNITS ARE IN FEET, INCHES, FRACTION OF INCHES AND DECIMALS.	CHECKED BY:	
APPROVED BY:	SCALE: NTS SIZE: B SHEET: 1 OF 1	TITLE: CABLE TO CABLE CONNECTOR KIT (2-4) #16 SOCKET CONTACTS MINI-CON-X
FILE: 08-02-12	DIRECTORY: SLW	CUSTOMER: STANDARD PRODUCT
PART NUMBER: 8380-XSG-5XX		REV: c

**RoHS COMPLIANT**