

**ENERGIZER LN91**  
Industrial

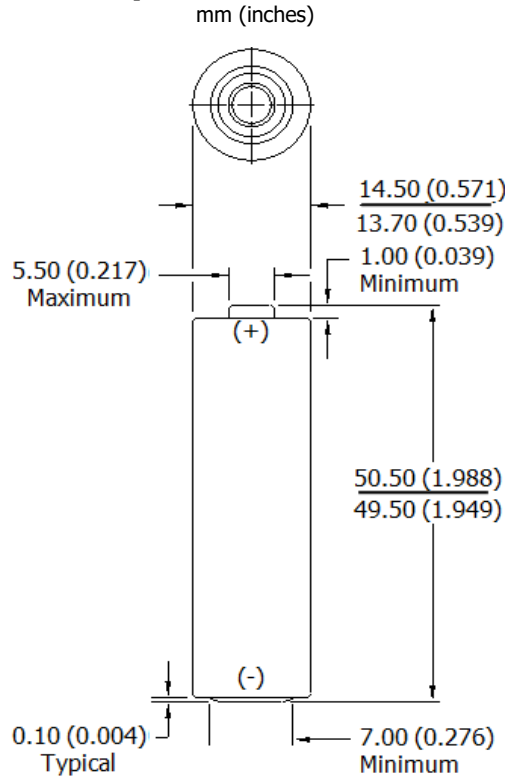



**Industry Standard Dimensions**



**General Information**

**AA**

<b>Classification:</b>	Primary Lithium
<b>Chemical System:</b>	Lithium/Iron Disulfide (Li/FeS <sub>2</sub> )
<b>Designation:</b>	ANSI 15-LF, IEC-FR14505 (FR6)
<b>Nominal Voltage:</b>	1.5 Volts
<b>Sizing Compatibility:</b>	E91 NH15 1215
<b>Storage Temp:</b>	-40°C to 60°C (-40°F to 140°F)
<b>Operating Temp:</b>	-40°C to 60°C (-40°F to 140°F)*
<b>Typical Weight:</b>	15 grams (0.5 oz.)
<b>Typical Volume:</b>	8.0 cubic centimeters (0.49 cubic inch)
<b>Max Discharge:</b>	2.5 amps continuous
(single battery only)	4.0 amps pulse (2 sec on / 8 sec off)
<b>Lithium Content:</b>	Less than 1 gram
<b>Typical IR:</b>	120 to 240 milliohms (depending on method)
<b>Shelf Life:</b>	20 years at 21°C
<b>More Details:</b>	<a href="#">On-Line Catalog-Application Manual (Li/FeS<sub>2</sub>)</a>
<b>Shipping:</b>	Please refer to PSDS Document
<b>Certifications:</b>	 

\*All data shown tested at 21°C unless otherwise stated.

**Milliamp-Hours Capacity**

Constant Current Discharge to 0.8 Volts

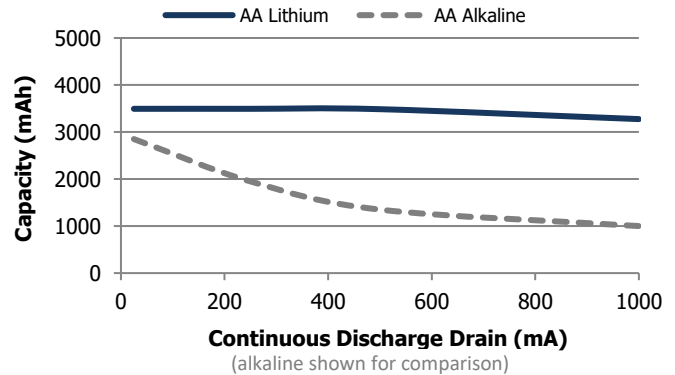

**Discharge Profile**

Constant Current Discharge

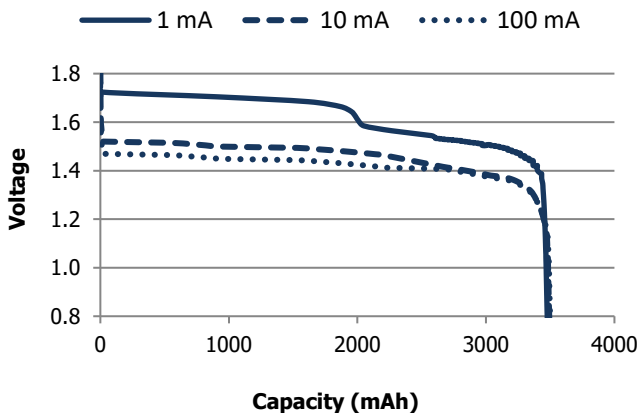

**Temperature Effects on Capacity**

Constant Current Discharge

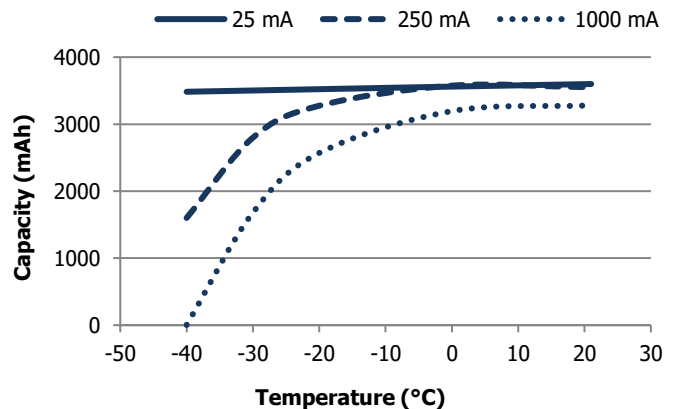

**Important Notice**

This datasheet contains typical information specific to products manufactured at the time of its publication. **Contents herein do not constitute a warranty and are for reference only.**

# Industrial LN91

**AA**

## Internal Resistance Profile

Cell Ohmic Resistance - Dual Pulse Method

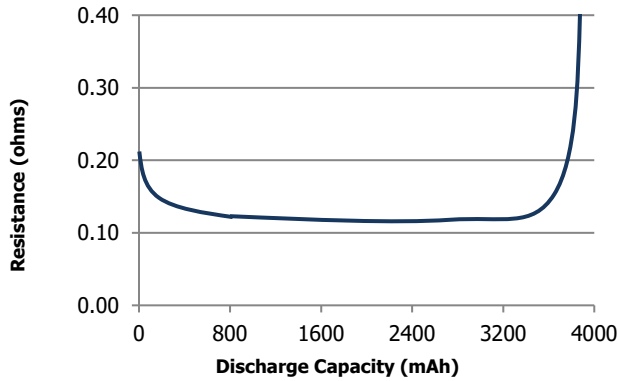

## Pulse Response

Open Circuit Voltage - 100/500/1k mA Pulse

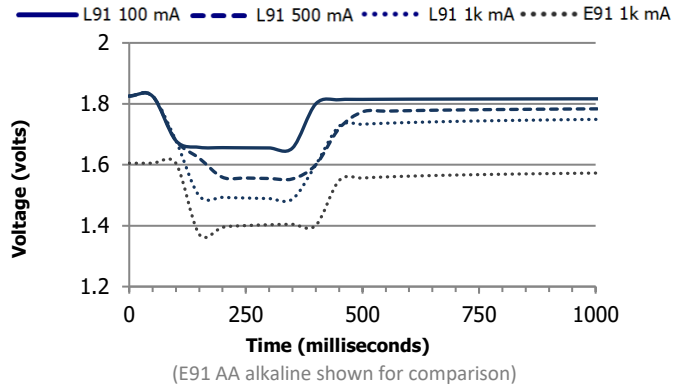

## Constant Power Performance

Typical Characteristics to 0.8 Volts

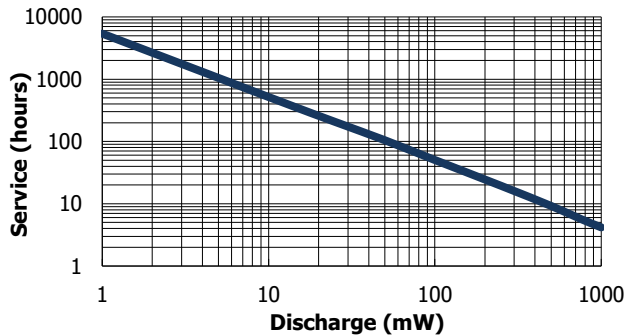

## Constant Current Performance

Typical Characteristics to 0.8 Volts

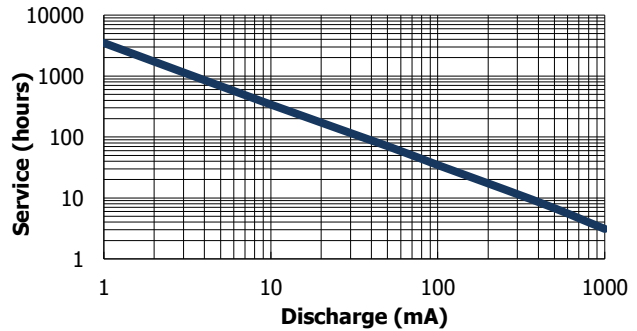

## Application Tests

REMOTE/RADIO /CLOCK  
50 mA 1 hr/8 hrs day

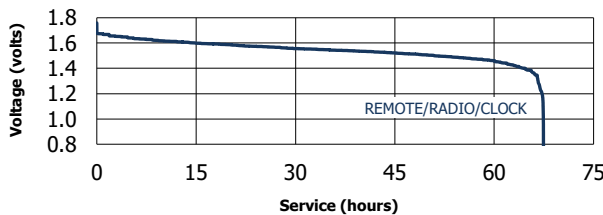

## Application Tests

CD/GAMES 250 mA 1 hr/day  
DIGITAL AUDIO 100 mA 1 hr/day

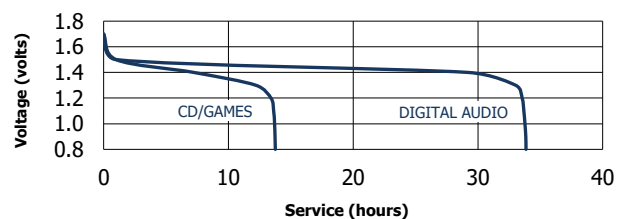

## Application Tests

PORTABLE LIGHTING 3.3 ohm LIF  
TOY 3.9 ohm 1 hr/day

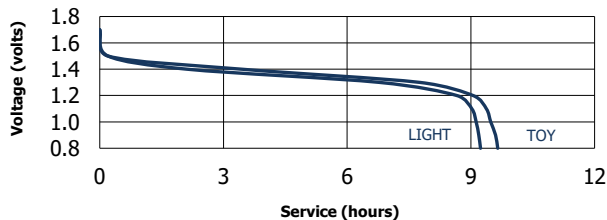

## Industry Standard Tests

PERSONAL GROOMING 750 mA 2 min/hr 8 hrs/day  
DIGITAL CAMERA 1.5/.65K mW 2/.1/27.9s 10X



### Important Notice

This datasheet contains typical information specific to products manufactured at the time of its publication.  
**Contents herein do not constitute a warranty and are for reference only.**