

FLORENCE-1R-Z60

~60° + 110° medium beam

TECHNICAL SPECIFICATIONS:

Dimensions	19.5 x 286.0 mm
Height	7.6 mm
Fastening	clips
Colour	clear
Box size	398 x 298 x 265 mm
Box weight	7.1 kg
Quantity in Box	165 pcs
ROHS compliant	yes ⓘ



MATERIAL SPECIFICATIONS:

Component	Type	Material	Colour
FLORENCE-1R-Z60	Linear lens	PMMA	clear

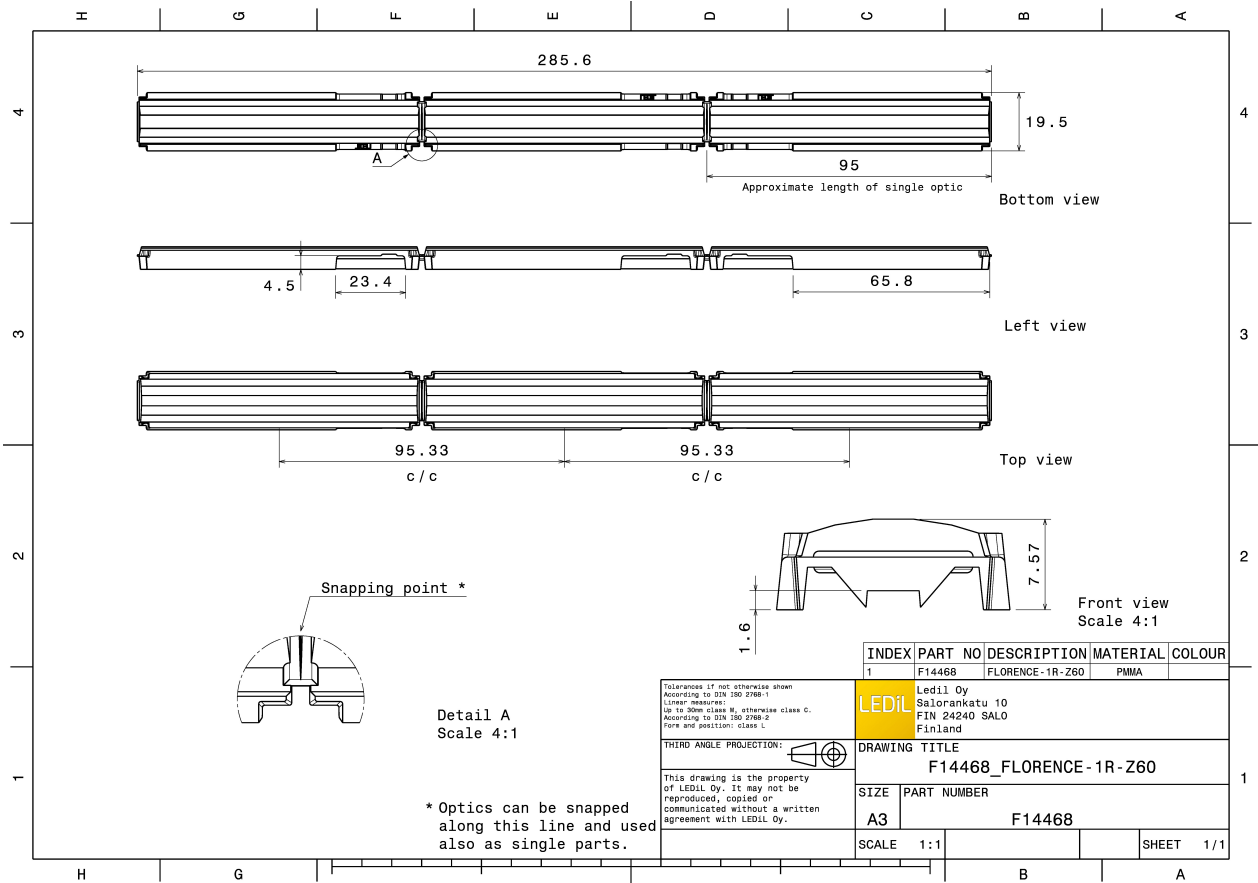

PHOTOMETRIC DATA (MEASURED):



LED CALGD0414-M8W1
 FWHM 58.0 + 121.0°
 Efficiency 94 %
 Peak intensity 0.550 cd/lm
 LEDs/each optic 1
 Light colour White
 Required components:

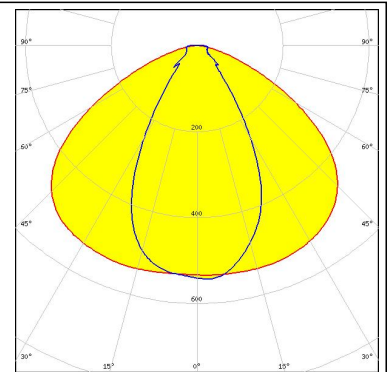

LED CALGD0814-M17W1
 FWHM 57.0 + 118.0°
 Efficiency 92 %
 Peak intensity 0.550 cd/lm
 LEDs/each optic 1
 Light colour White
 Required components:

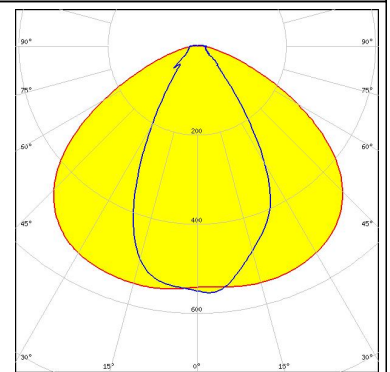

LED L0-280024-xxx-C0800-L267
 FWHM 65.0 + 107.0°
 Efficiency 93 %
 Peak intensity 0.530 cd/lm
 LEDs/each optic 1
 Light colour White
 Required components:

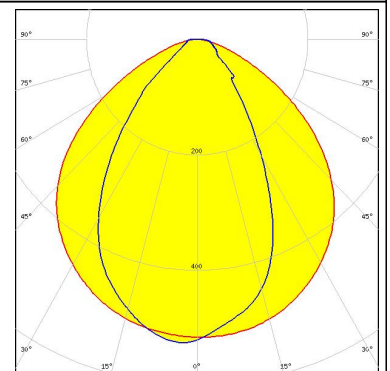
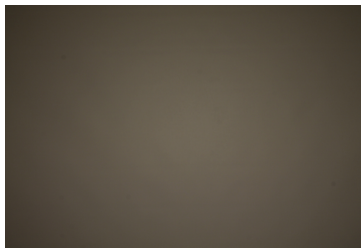

LED XH-B/G
 FWHM 63.0 + 113.0°
 Efficiency 94 %
 Peak intensity 0.540 cd/lm
 LEDs/each optic 1
 Light colour White
 Required components:

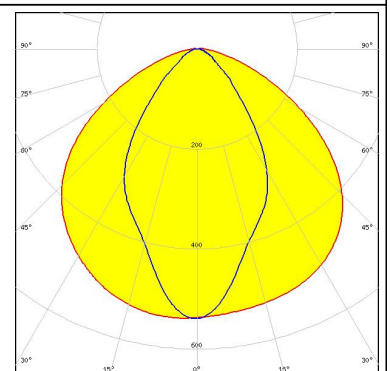
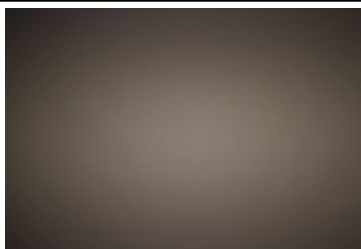

PHOTOMETRIC DATA (MEASURED):

LUMILEDS

LED LUXEON 3014
 FWHM 59.0 + 115.0°
 Efficiency 94 %
 Peak intensity 0.640 cd/lm
 LEDs/each optic 1
 Light colour White
 Required components:

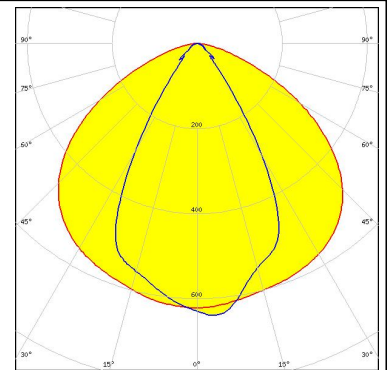

LUMILEDS

LED LUXEON 3020
 FWHM 55.0 + 117.0°
 Efficiency 94 %
 Peak intensity 0.660 cd/lm
 LEDs/each optic 1
 Light colour White
 Required components:

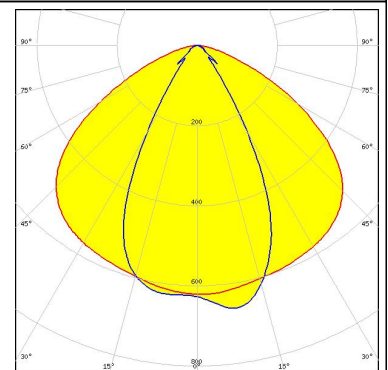

LUMILEDS

LED LUXEON 3030 2D (Round LES)
 FWHM 57.0 + 114.0°
 Efficiency 94 %
 Peak intensity 0.600 cd/lm
 LEDs/each optic 1
 Light colour White
 Required components:

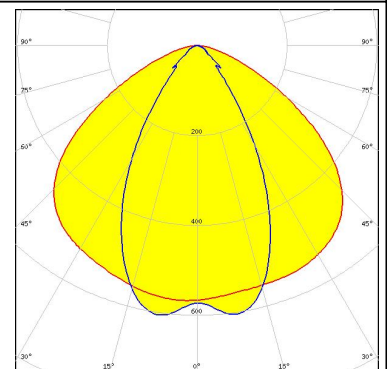
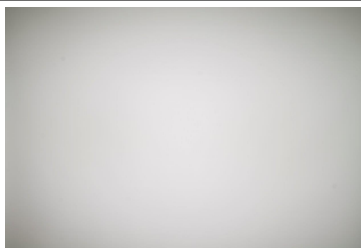

LUMILEDS

LED LUXEON 3535 2D
 FWHM 60.0 + 109.0°
 Efficiency 94 %
 Peak intensity 0.590 cd/lm
 LEDs/each optic 1
 Light colour White
 Required components:

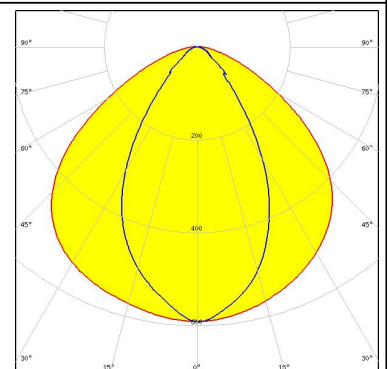
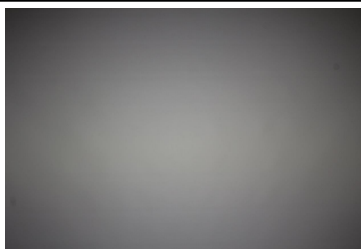

PHOTOMETRIC DATA (MEASURED):

LUMILEDS

LED LUXEON 3535L
 FWHM 59.0 + 110.0°
 Efficiency 94 %
 Peak intensity 0.620 cd/lm
 LEDs/each optic 1
 Light colour White
 Required components:

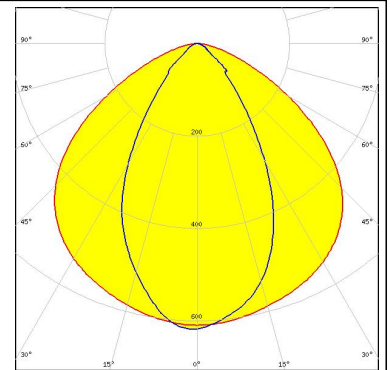

LUMINUS

LED MP-2016
 FWHM 58.0 + 115.0°
 Efficiency 94 %
 Peak intensity 0.630 cd/lm
 LEDs/each optic 1
 Light colour White
 Required components:

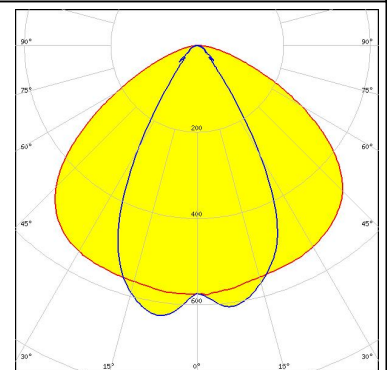

NICHIA

LED NF2x757D
 FWHM 59.0 + 114.0°
 Efficiency 94 %
 Peak intensity 0.570 cd/lm
 LEDs/each optic 1
 Light colour White
 Required components:

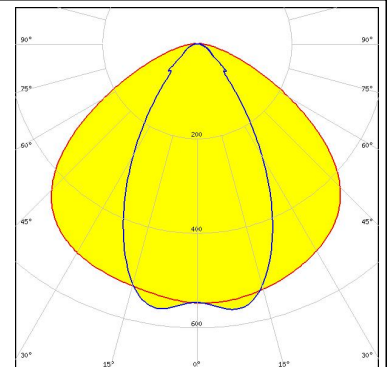

NICHIA

LED NF2x757G
 FWHM 56.0 + 111.0°
 Efficiency 93 %
 Peak intensity 0.600 cd/lm
 LEDs/each optic 1
 Light colour White
 Required components:

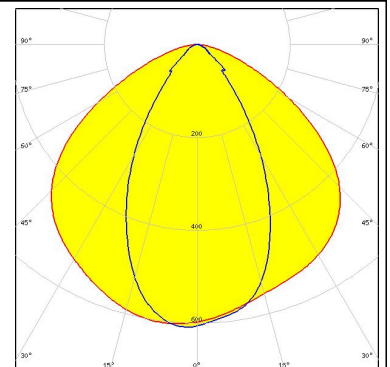

PHOTOMETRIC DATA (MEASURED):



LED NF2x757G
FWHM 112.0 + 52.0°
Efficiency 70 %
Peak intensity 0.499 cd/lm
LEDs/each optic 1
Light colour White
Required components:
 C14593_FLORENCE-1R-SHD-BLK

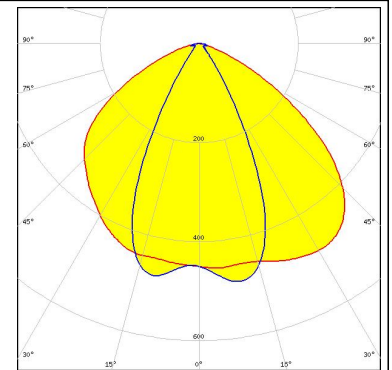

LED NFSW757H
FWHM 107.0 + 60.0°
Efficiency 94 %
Peak intensity 0.587 cd/lm
LEDs/each optic 1
Light colour White
Required components:
 C14353_FLORENCE-1R-CLIP-A

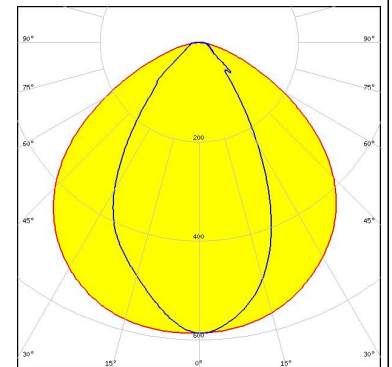

LED Duris E5
FWHM 112.0 + 58.0°
Efficiency 94 %
Peak intensity 0.610 cd/lm
LEDs/each optic 1
Light colour White
Required components:

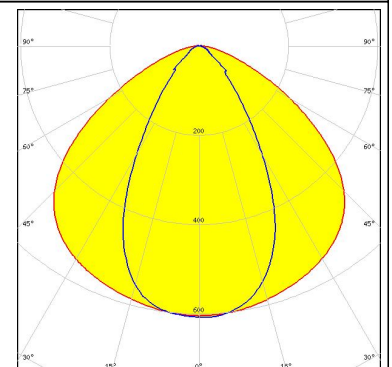
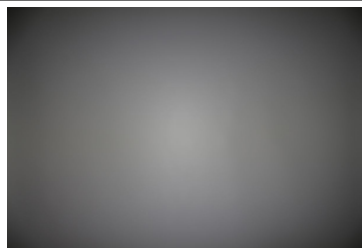

LED Duris S5 (2 chip)
FWHM 58.0 + 114.0°
Efficiency 94 %
Peak intensity 0.590 cd/lm
LEDs/each optic 1
Light colour White
Required components:

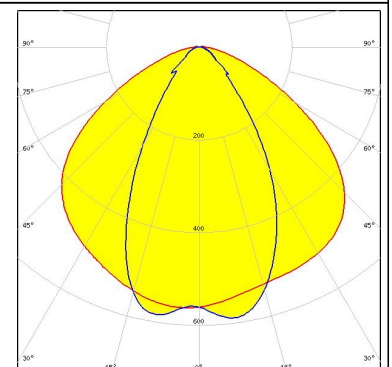
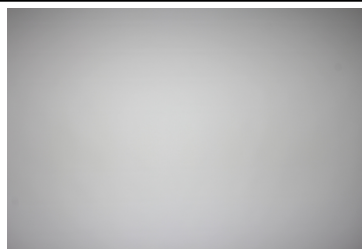

PHOTOMETRIC DATA (MEASURED):

SAMSUNG

LED LM28xB Series
 FWHM 111.0 + 59.0°
 Efficiency 94 %
 Peak intensity 0.593 cd/lm
 LEDs/each optic 1
 Light colour White
 Required components:
 C14409_FLORENCE-1R-CLIP-B

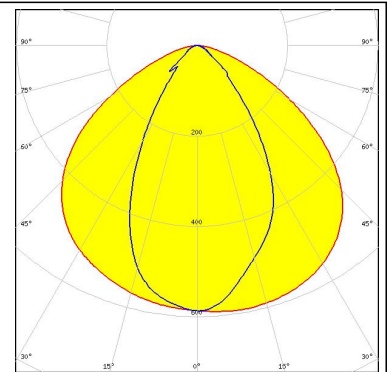
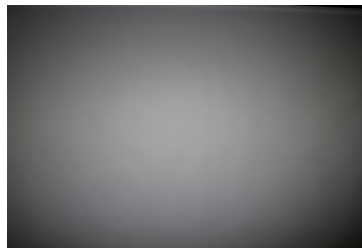

SAMSUNG

LED LM28xB Series
 FWHM 57.0 + 113.0°
 Efficiency 94 %
 Peak intensity 0.620 cd/lm
 LEDs/each optic 1
 Light colour White
 Required components:

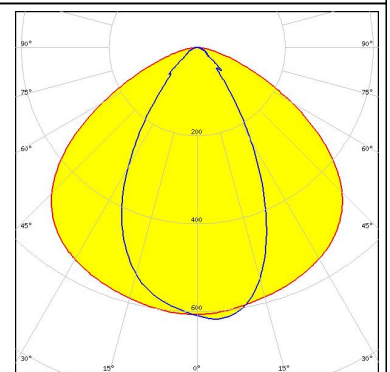
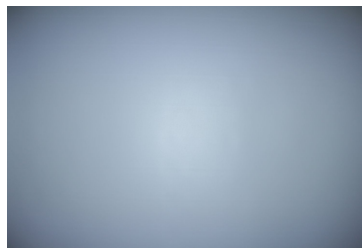

SAMSUNG

LED LM301A
 FWHM 56.0 + 113.0°
 Efficiency 94 %
 Peak intensity 0.640 cd/lm
 LEDs/each optic 1
 Light colour White
 Required components:

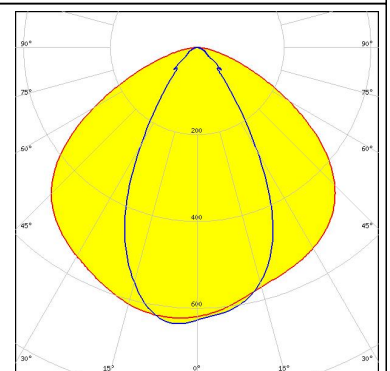
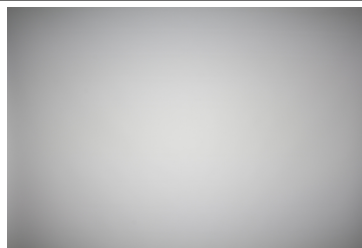

SAMSUNG

LED LM302A
 FWHM 59.0 + 111.0°
 Efficiency 94 %
 Peak intensity 0.600 cd/lm
 LEDs/each optic 1
 Light colour White
 Required components:

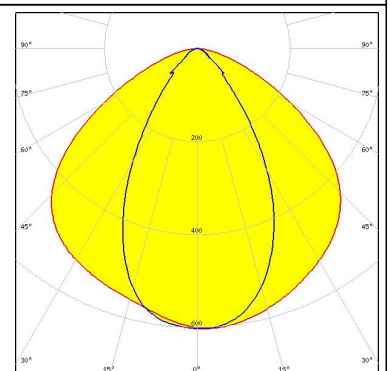
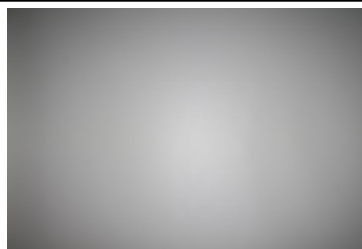

PHOTOMETRIC DATA (MEASURED):

SAMSUNG

LED LM561B
 FWHM 59.0 + 111.0°
 Efficiency 94 %
 Peak intensity 0.580 cd/lm
 LEDs/each optic 1
 Light colour White
 Required components:

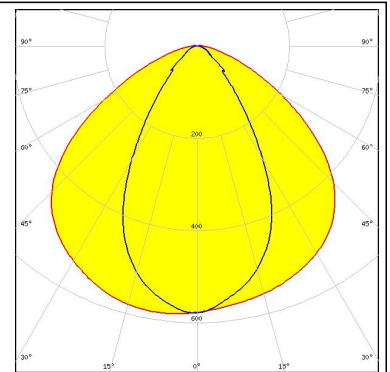
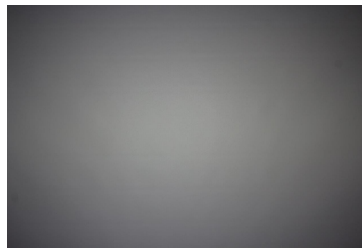

SAMSUNG

LED LM561B Plus
 FWHM 117.0 + 58.0°
 Efficiency 94 %
 Peak intensity 0.605 cd/lm
 LEDs/each optic 1
 Light colour White
 Required components:
 C14353_FLORENCE-1R-CLIP-A

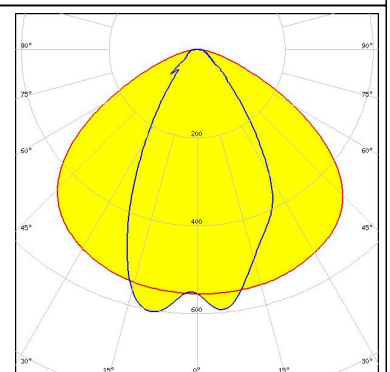
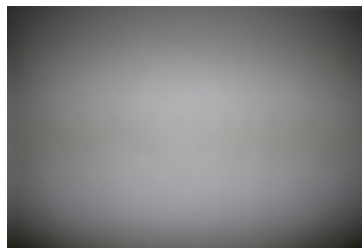

SAMSUNG

LED LM561C
 FWHM 56.0 + 113.0°
 Efficiency 94 %
 Peak intensity 0.630 cd/lm
 LEDs/each optic 1
 Light colour White
 Required components:

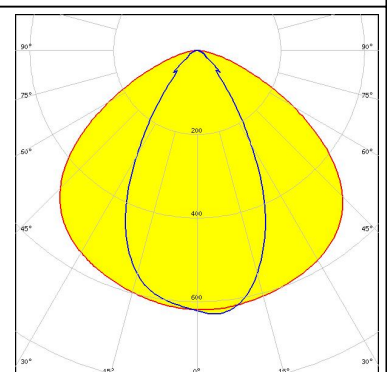
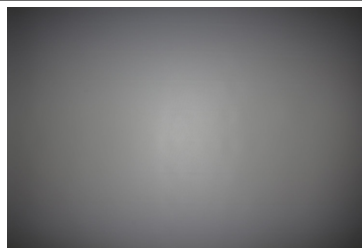

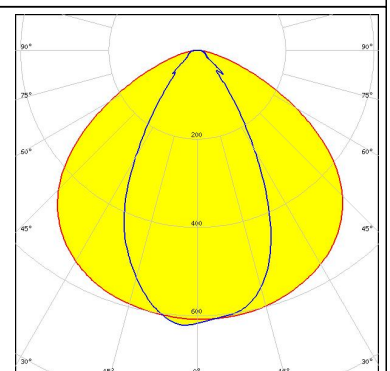

SAMSUNG

LED LT-S282N
 FWHM 56.0 + 112.0°
 Efficiency 94 %
 Peak intensity 0.620 cd/lm
 LEDs/each optic 1
 Light colour White
 Required components:

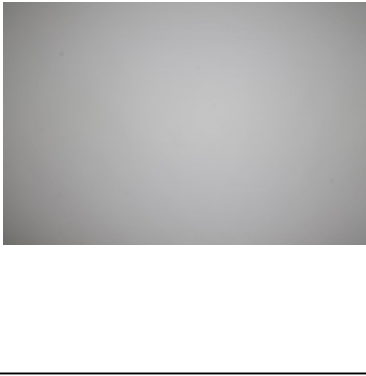
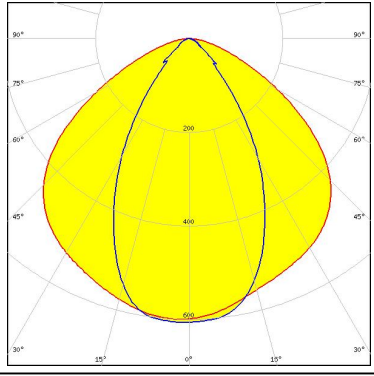

PHOTOMETRIC DATA (MEASURED):

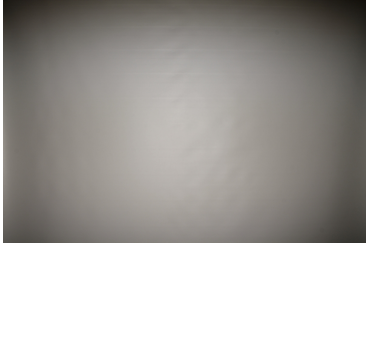
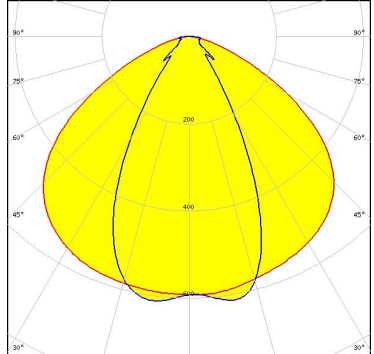
<p> SEOUL SEMICONDUCTOR</p> <p>LED SEOUL 3030 FWHM 59.0 + 111.0° Efficiency 94 % Peak intensity 0.600 cd/lm LEDs/each optic 1 Light colour White Required components:</p>		
<p> SEOUL SEMICONDUCTOR</p> <p>LED SEOUL DC 3030 FWHM 115.0 + 55.0° Efficiency 94 % Peak intensity 0.610 cd/lm LEDs/each optic 1 Light colour White Required components: C14353_FLORENCE-1R-CLIP-A</p>		

PHOTOMETRIC DATA (SIMULATED):

<p>LUMILEDS</p> <p>LED LUXEON 2835 Line FWHM 59.0 + 107.0° Efficiency 94 % Peak intensity 0.650 cd/lm LEDs/each optic 1 Light colour White Required components:</p>	
<p>LUMILEDS</p> <p>LED LUXEON 5050 Round LES FWHM 61.0 + 107.0° Efficiency 94 % Peak intensity 0.570 cd/lm LEDs/each optic 1 Light colour White Required components:</p>	
<p>OSRAM <small>Opto Semiconductors</small></p> <p>LED Duris E 2835 FWHM 61.0 + 107.0° Efficiency 94 % Peak intensity 0.600 cd/lm LEDs/each optic 1 Light colour White Required components:</p>	
<p>SEOUL SEMICONDUCTOR</p> <p>LED SEOUL DC 3030C FWHM 107.0 + 62.0° Efficiency 95 % Peak intensity 0.625 cd/lm LEDs/each optic 1 Light colour White Required components:</p>	

GENERAL INFORMATION:

NOTE: The typical beam angle will be changed by different color, chip size and chip position tolerance. The typical total beam angle is the full angle measured where the luminous intensity is half of the peak value.

MATERIALS:

As part of our continuous research and improvement processes, and to ensure the best possible quality and availability of our products, LEDiL reserves the right to change material grades without notice.

PRODUCT DATA USER AGREEMENT AND DISCLAIMER:

The measured data in the provided downloadable LEDiL Product Datasheets and Mechanical 2D-Drawings is rounded and provided as reference for planning. LEDiL Oy's optical specifications have been verified by conducting performance testing of the products in accordance with the company's quality system. The reported data are averaged results of multiple measurements with typical variation. LEDiL Oy reserves the right to without prior notification make changes and improvements to its products.

LEDiL Oy assumes neither warranty, nor guarantee nor any other liability of any kind for the contents and correctness of the provided data. The provided data has been generated with highest diligence but the provided data may in reality not represent the complete possible variation range of all intrinsic parameters. Therefore, in certain cases a deviation from the provided data could occur.

LEDiL Oy reserves the right to undertake technical changes of its products without further notification which could lead to changes in the provided data. LEDiL Oy assumes no liability of any kind for the possible deviation from any provided data or any other damage resulting from the usage of the provided data.

The user agrees to this disclaimer and user agreement with the download or usage of the provided files.

LEDiL Oy

Joensuunkatu 13
FI-24240 SALO
Finland

LEDiL Inc.

228 West Page Street
Suite D
Sycamore IL 60178
USA

Local sales and technical support

[www.ledil.com/
where_to_buy](http://www.ledil.com/where_to_buy)

Shipping locations

Salo, Finland
Hong Kong, China

Distribution Partners

[www.ledil.com/
where_to_buy](http://www.ledil.com/where_to_buy)