

Si8935/36/37 Data Sheet

Delta-Sigma Modulator for Voltage Measurement

The Si8935/36/37 is a galvanically isolated delta-sigma modulator optimized for voltage sensing. Its 2.5 V input range is ideal for isolated voltage sensing applications. The Si8935/36/37 provides excellent linearity with low offset and gain drift to ensure that accuracy is maintained over the entire operating temperature range. Exceptionally high common-mode transient immunity means that the Si8935/36/37 delivers accurate measurements even in the presence of high-power switching as is found in motor drive systems and inverters.

The output of the Si8935/36/37 comes from a second-order, delta-sigma modulator. The modulator can be clocked either from an onboard oscillator (Si8936/37) or from an external clock (Si8935). The output is typically digitally filtered by a MCU or FPGA in the system.

The Si8935/36/37 isolated delta-sigma modulator utilizes Skyworks' proprietary isolation technology. It supports up to 5.0 kVrms withstand voltage per UL1577. This technology enables higher performance, reduced variation with temperature and age, tighter part-to-part matching, and longer lifetimes compared to other isolation technologies.

Applications:

- Industrial, HEV and renewable energy inverters
- AC, Brushless, and DC motor controls and drives
- Variable speed motor control in consumer white goods
- Isolated switch mode and UPS power supplies
- General industrial data acquisition and sensor interface
- Automotive onboard chargers, battery management systems, and charging stations

Safety Approvals:

- UL 1577 recognized
 - Up to 5000 Vrms for 1 minute
- CSA approval
 - 62368-1 (reinforced insulation)
- VDE certification conformity
 - EN62368-1 (reinforced insulation)
 - Pending IEC60747-17 (basic/reinforced insulation)
- CQC certification approval
 - GB4943.1-2011

KEY FEATURES

- 0 to 2.5 V nominal input voltage
- Modulator clock options
 - External clock up to 25 MHz (Si8935)
 - 10 MHz internal clock (Si8936)
 - 20 MHz internal clock (Si8937)
- Typical input offset: ± 0.4 mV
- Typical gain error: $\pm 0.05\%$
- Excellent drift specifications
 - ± 0.5 $\mu\text{V}/^\circ\text{C}$ typical offset drift
 - 9 ppm/ $^\circ\text{C}$ typical gain drift
- Typical nonlinearity: 0.003%
- Typical SNR: 86 dB
- High common-mode transient immunity: 75 kV/ μs
- Automotive-grade OPNs
 - AIAG-compliant PPAP documentation support
 - IMDS and CAMDS listing support
- Compact packages
 - 8-pin wide body stretched SOIC
 - 8-pin narrow body SOIC
- -40 to 125 $^\circ\text{C}$

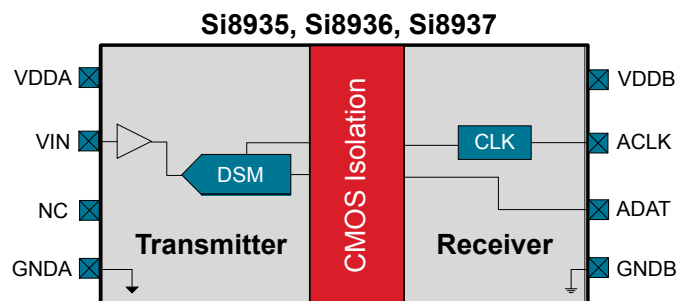

1. Ordering Guide

Table 1.1. Si8935-36-37 Ordering Guide^{1, 2, 3}

Ordering Part Number (OPN)	Automotive OPN ⁴	Ordering Options		
		Isolation Rating	Clock	Package Type
Si8935D-IS4	Si8935D-AS4	5.0 kVrms	Input	WB Stretched SOIC-8
Si8935B-IS	Si8935B-AS	2.5 kVrms	Input	NB SOIC-8
Si8936D-IS4	Si8936D-AS4	5.0 kVrms	10 MHz Output	WB Stretched SOIC-8
Si8936B-IS	Si8936B-AS	2.5 kVrms	10 MHz Output	NB SOIC-8
Si8937D-IS4	Si8937D-AS4	5.0 kVrms	20 MHz Output	WB Stretched SOIC-8
Si8937B-IS	Si8937B-AS	2.5 kVrms	20 MHz Output	NB SOIC-8

Note:

1. All packages are RoHS-compliant.
2. "Si" and "SI" are used interchangeably.
3. AEC-Q100 pending qualification.
4. Automotive-Grade devices ("-A" suffix) are identical in construction materials, topside marking, and electrical parameters to their Industrial-Grade ("-I" suffix) version counterparts. Automotive-Grade products are produced utilizing full automotive process flows and additional statistical process controls throughout the manufacturing flow. The Automotive-Grade part number is included on shipping labels.

Table of Contents

1. Ordering Guide	2
2. System Overview	4
2.1 Fail-Safe and Low-Power Modes	4
2.2 Modulator	5
3. Voltage Sense Application	6
4. Electrical Specifications	7
4.1 Regulatory Information	.13
4.2 Typical Operating Characteristics	.15
5. Pin Descriptions	20
6. Packaging	21
6.1 Package Outline: 8-Pin Wide Body Stretched SOIC	.21
6.2 Package Outline: 8-Pin Narrow Body SOIC	.23
6.3 Land Pattern: 8-Pin Wide Body Stretched SOIC	.25
6.4 Land Pattern: 8-Pin Narrow Body SOIC	.26
6.5 Top Marking: 8-Pin Wide Body Stretched SOIC	.27
6.6 Top Marking: 8-Pin Narrow Body SOIC	.28
7. Revision History	29

2. System Overview

The input to the Si8935/36/37 is designed for 0 to 2.5 V nominal input.

The analog input stage of the Si8935/36/37 is a single-ended amplifier feeding the input of a second-order, delta-sigma ($\Delta\Sigma$) modulator that digitizes the input signal into a 1-bit output stream. The isolated data output ADAT pin of the converter provides a stream of digital ones and zeros that is synchronous to the ACLK pin. The Si8936/37 clock is generated internally while the Si8935 clock is provided externally. The time average of this serial bit-stream output is proportional to the analog input voltage.

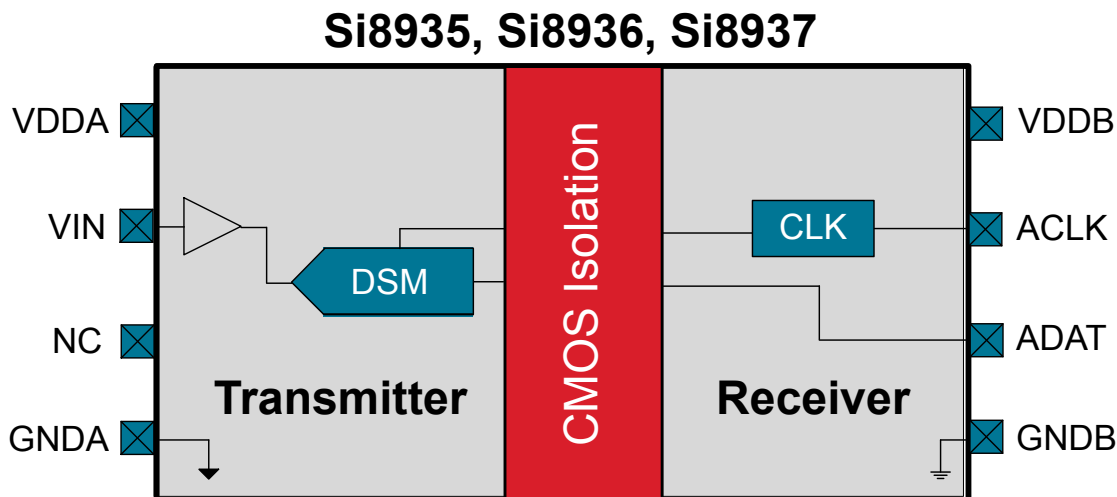

Figure 2.1. Si8935/36/37 Functional Block Diagram

2.1 Fail-Safe and Low-Power Modes

The Si8935/36/37 implements a fail-safe output when the high-side supply voltage VDDA goes away. The fail-safe output is steady state logic 0 on ADAT for the externally clocked Si8935. The fail-safe output is a steady state logic 1 on ADAT for the internally clocked Si8936/37. The clock output ACLK of the Si8946/47 will stop after 256 cycles with a steady state logic 1. When the supply comes back, the clock will be turned back on and normal DSM data stream will be output in approximately 200 μ s. To differentiate from the fail-safe output, a maximum nominal input signal will generate a single one every 128 bits at ADAT.

In addition to the fail-safe output, when a loss of VDDA supply occurs the part will automatically move into a lower power mode that reduces IDDB current to approximately 1 mA. Similarly, a loss of VDDB supply will reduce IDDA current to approximately 1 mA. When the supply voltage is returned, normal operation begins in approximately 250 μ s.

2.2 Modulator

The output of the Si8935/36/37 comes from a second-order, delta-sigma modulator like that shown in the figure below. The modulator provides 1-bit datastream whose average represents the input analog voltage. 0 V across the inputs is represented at the output by a pulse train that has 50% ones density. Specified linear full-scale at the input (e.g., +2.25 V) produces an output datastream that has 92.87% ones density.

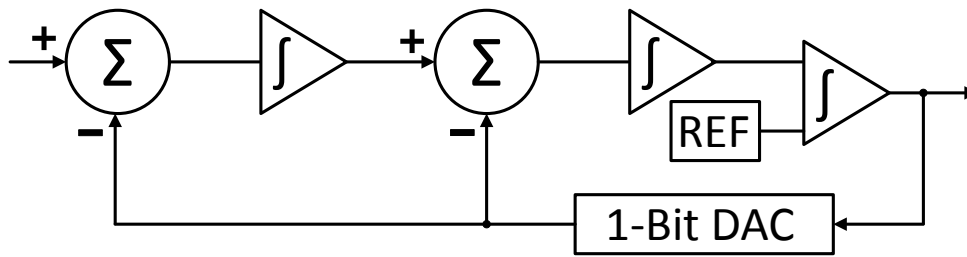

Figure 2.2. Typical 2nd Order Delta-Sigma Modulator Block Diagram

Table 2.1. Modulator Output

Single-Ended Input	Bitstream % Ones
2.25 V	92.87%
1.125 V	71.44%
0 V	50%

3. Voltage Sense Application

A typical isolated voltage sensing application circuit is shown below. In this example, a high voltage is divided down to produce a voltage (V_{IN}) within the optimum input signal range of the Si8935/36/37. Numerous alternative inputs configurations are possible with the flexibility of a high impedance input isolator. The Si8935/36/37 senses the single-ended input voltage where it is oversampled and converted into a 1-bit bitstream, then transmitted across the isolation barrier to be processed by the system controller/FPGA. If the voltage sensed is > 2.5 V, a simple voltage divider consisting of R_1 and R_2 can be used to scale down any voltage to fit the input range of the Si8935/36/37. $R_2 < 10$ k Ω is recommended for best performance.

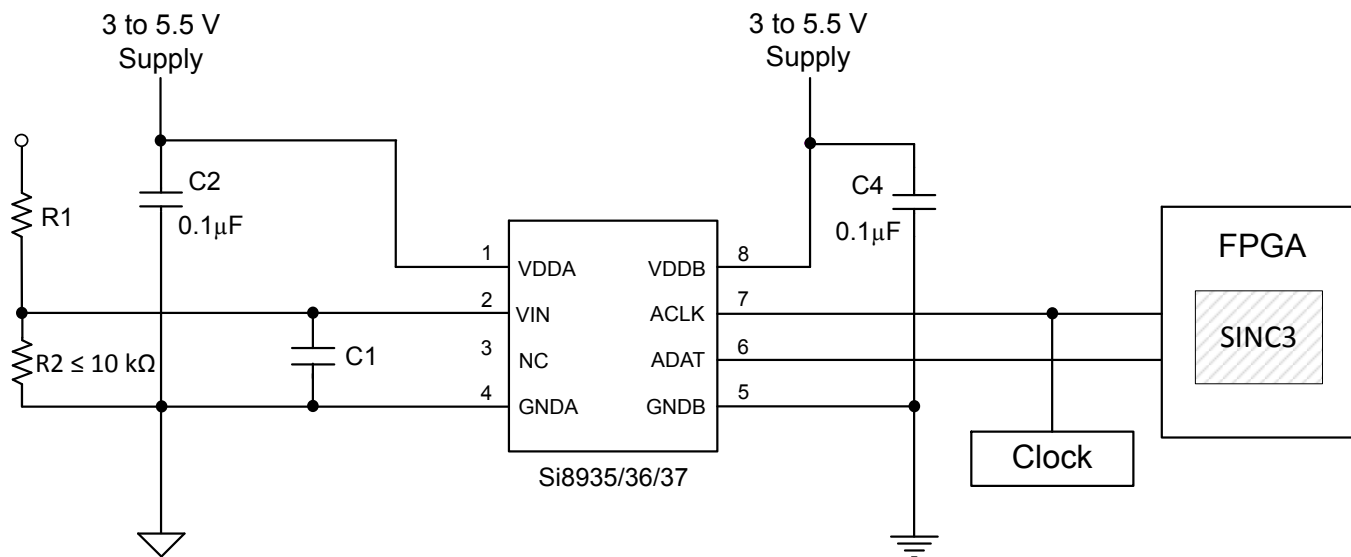

Figure 3.1. Voltage Sense Application

The Si8935/36/37 has intrinsic low-pass filtering at approximately 800 kHz. For applications where input filtering is required, a passive RC low-pass filter can be placed at the input pin. Consider the source resistance of the signal measured (or the parallel combination of R_1 and R_2 if using a voltage divider) as it should be included in the filter calculation. Capacitor C1 should be sized to make a band limiting filter at the desired frequency.

C4, the local bypass capacitor for the B-side of Si8935/36/37, should be placed close to VDDB supply pin with its return close to GNDB. The output signal typically goes directly to a digital filter for additional processing. The digital filter may be implemented by a dedicated FPGA in the system or may be a peripheral in the main system controller. The Si8935 expects an external clock to provide the clock signal for the modulator. That external clock can be provided by the same device that implements the digital filtering or another device that syncs both the modulator and the digital filter. The Si8936/37 generates an internal clock to the digital filter.

4. Electrical Specifications

Table 4.1. Electrical Specifications

$T_A = -40$ to $+125$ °C, SINC3 filter with 256 oversampling ratio and 20 MHz clock; typical specs at 25 °C and $V_{DDA} = V_{DDB} = 5V$ unless specified otherwise

Parameter	Symbol	Test Condition	Min	Typ	Max	Units
Input Side Supply Voltage	VDDA		3.0		5.5	V
Input Supply Current	IDDA	VDDA = 3.3 V	5.1	7	8.7	mA
Output Side Supply Voltage	VDDB		3.0		5.5	V
Output Supply Current (Si8935)	IDDB	VDDB = 3.3 V	1	1.8	2.7	mA
Output Supply Current (Si8936)	IDDB	VDDB = 3.3 V	2.3	4.4	7.2	mA
Output Supply Current (Si8937)	IDDB	VDDB = 3.3 V	3.4	6.1	11	mA
Amplifier Input						
Specified Linear Input Range	VIN		0.25		2.25	V
Maximum Input Voltage Before Clipping	VIN			2.5		V
Input Referred Offset	VOS	$T_A = 25$ °C, $V_{IN} = 0.25$ V	-3	± 0.4	3	mV
Input Offset Drift	V_{OS_T}		-40	± 0.5	25	$\mu V/^\circ C$
Input Impedance	RIN			500		M Ω
Dynamic Characteristics						
Gain				1		
Gain Error		$T_A = 25$ °C	-0.15	± 0.05	0.15	%
Gain Error Drift			-7	9	20	ppm/°C
Nonlinearity		$T_A = 25$ °C	-0.016	0.003	0.016	%
Nonlinearity Drift			-1		1	ppm/°C
Signal-to-Noise Ratio	SNR	$F_{IN} = 5$ kHz BW = 40 kHz (Si8935/37) BW = 20 kHz (Si8936)	73	86		dB
Total Harmonic Distortion	THD	$F_{IN} = 5$ kHz BW = 40 kHz (Si8935/37) BW = 20 kHz (Si8936)		-83	-60	dB
Common-Mode Transient Immunity	CMTI	$V_{IN} = G_{NDA}$, $V_{CM} = 1500$ V	50	75		kV/ μs

Parameter	Symbol	Test Condition	Min	Typ	Max	Units
Power-Supply Rejection Ratio	PSRR	VDDA at DC		-100		dB
		VDDA at 100 mV and 10 kHz ripple		-100		dB
		VDDB at DC		-100		dB
		VDDB at 100 mV and 10 kHz ripple		-100		dB
Digital						
Logic high input threshold (Si8935)	VIH		85% of VDDB			V
Logic low input threshold (Si8935)	VIL				15% of VDDB	V
Input hysteresis	VIHYST			120		mV
Output load capacitance	C _{LOAD}			15		pF
External Clock (Si8935)						
Clock Frequency	FCLKIN		5		25	MHz
Duty Cycle	FDUTY		45	50	55	%
Delay to Data Valid	TDELAY				23	ns
Data Hold Time	THOLD		6			ns
Internal Clock (Si8936)						
Clock Frequency	FCLKOUT	T _A = 25 °C	9.9	10	10.1	MHz
		T _A = -40 °C to 125 °C	9.8	10	10.2	MHz
Duty Cycle	FDUTY		45	50	55	%
Delay to Data Valid	TDELAY				60	ns
Data Hold Time	THOLD		40			ns
Internal Clock (Si8937)						
Clock Frequency	FCLKOUT	T _A = 25 °C	19.8	20	20.2	MHz
		T _A = -40 °C to 125 °C	19.6	20	20.4	MHz
Duty Cycle	FDUTY		45	50	55	%
Delay to Data Valid	TDELAY				30	ns
Data Hold Time	THOLD		20			ns

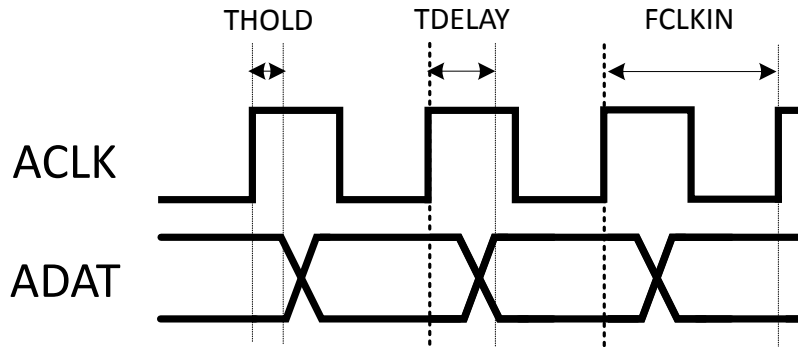

Figure 4.1. Si8935 Clock Input

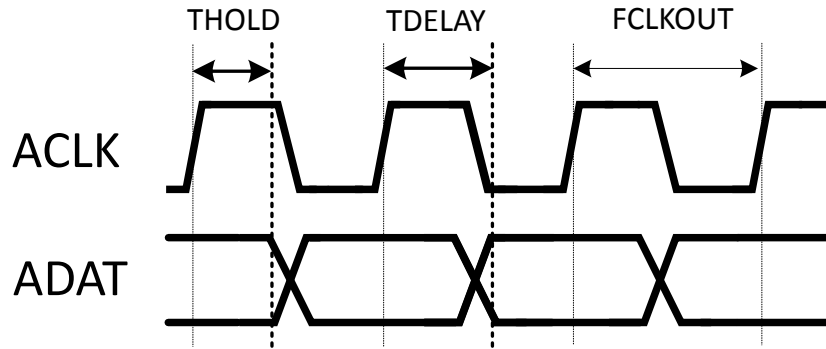

Figure 4.2. Si8936/37 Clock Output

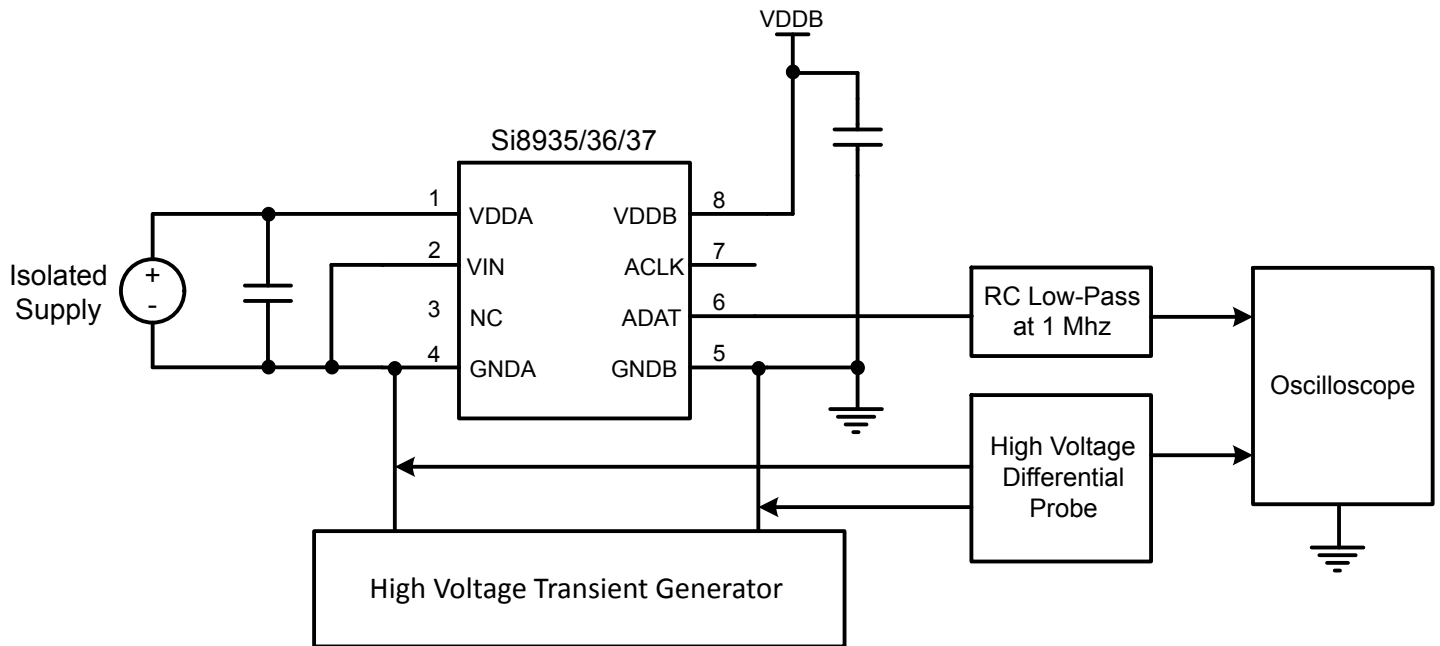

Figure 4.3. Common-Mode Transient Immunity Characterization Circuit

Table 4.2. IEC 60747-17 Safety Limiting Values¹

Parameter	Symbol	Test Condition	Characteristic	Unit
Safety Temperature	T_S		150	°C
Safety Input Current (WB Stretched SOIC-8)	I_S	$\theta_{JA} = 90 \text{ }^\circ\text{C/W}$ $V_{DD} = 5.5 \text{ V}$ $T_J = 150 \text{ }^\circ\text{C}$ $T_A = 25 \text{ }^\circ\text{C}$	253	mA
		$\theta_{JA} = 90 \text{ }^\circ\text{C/W}$ $V_{DD} = 3.6 \text{ V}$ $T_J = 150 \text{ }^\circ\text{C}$ $T_A = 25 \text{ }^\circ\text{C}$	386	mA
Safety Input Current (NB SOIC-8)	I_S	$\theta_{JA} = 112 \text{ }^\circ\text{C/W}$ $V_{DD} = 5.5 \text{ V}$ $T_J = 150 \text{ }^\circ\text{C}$ $T_A = 25 \text{ }^\circ\text{C}$	203	mA
		$\theta_{JA} = 112 \text{ }^\circ\text{C/W}$ $V_{DD} = 3.6 \text{ V}$ $T_J = 150 \text{ }^\circ\text{C}$ $T_A = 25 \text{ }^\circ\text{C}$	310	mA
Safety Input Power (WB Stretched SOIC-8)	P_S	$\theta_{JA} = 90 \text{ }^\circ\text{C/W}$ $T_J = 150 \text{ }^\circ\text{C}$ $T_A = 25 \text{ }^\circ\text{C}$	1389	mW
Safety Input Power (NB SOIC-8)	P_S	$\theta_{JA} = 112 \text{ }^\circ\text{C/W}$ $T_J = 150 \text{ }^\circ\text{C}$ $T_A = 25 \text{ }^\circ\text{C}$	1116	mW
Note:				
1. Maximum value allowed in the event of a failure. Refer to the thermal derating curves below.				

Table 4.3. Thermal Characteristics

Parameter	Symbol	WB Stretched SOIC-8	NB SOIC-8	Unit
IC Junction-to-Air Thermal Resistance	θ_{JA}	90	112	°C/W

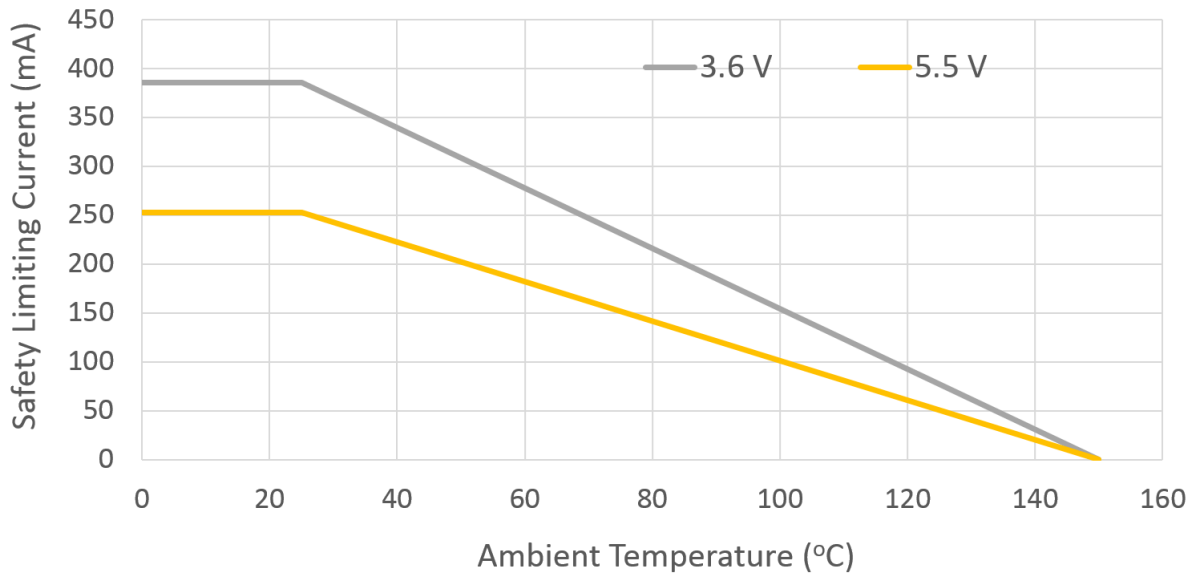

Figure 4.4. WB Stretched SOIC-8 Thermal Derating Curve for Safety Limiting Current

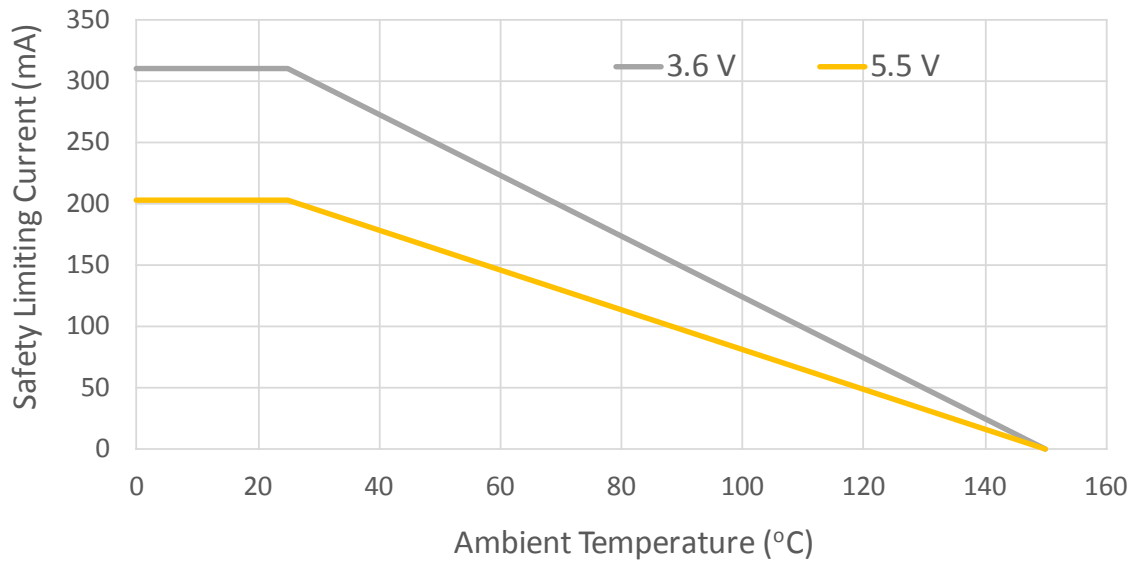

Figure 4.5. NB SOIC-8 Thermal Derating Curve for Safety Limiting Current

Table 4.4. Absolute Maximum Ratings¹

Parameter	Symbol	Min	Max	Unit
Storage Temperature	T_{STG}	-65	150	°C
Ambient Temperature Under Bias	T_A	-40	125	°C
Junction Temperature	T_J	—	150	°C
Supply Voltage	VDDA, VDDDB	-0.5	6.0	V
Input Voltage respect to GNDA	VIN	-0.5	VDDA + 0.5	V
Output Sink or Source Current	$ I_O $	—	5	mA
Total Power Dissipation	P_T	—	212	mW
Lead Solder Temperature (10 s)		—	260	°C
Human Body Model ESD Rating		6000	—	V
Capacitive Discharge Model ESD Rating		2000	—	V

Note:

1. Permanent device damage may occur if the absolute maximum ratings are exceeded. Functional operation should be restricted to conditions as specified in the operational sections of the data sheet.

4.1 Regulatory Information

Table 4.5. Regulatory Information (Pending)^{1, 2}

CSA
The Si8935/36/37 is certified under CSA. For more details, see Master Contract File 232873.
62368-1: Up to 600 V _{RMS} reinforced insulation working voltage; up to 1000 V _{RMS} basic insulation working voltage.
VDE
The Si8935/36/37 is pending certification under VDE. For more details, see File 5028467.
IEC60747-17: Up to 2121 V _{peak} for reinforced insulation working voltage.
EN62368-1: Up to 600 V _{RMS} reinforced insulation working voltage; up to 1000 V _{RMS} basic insulation working voltage.
UL
The Si8935/36/37 is certified under UL1577 component recognition program. For more details, see File E257455.
Rated up to 5000 V _{RMS} isolation voltage for basic protection.
CQC
The Si8935/36/37 is certified under GB4943.1-2011.
Rated up to 250 V _{RMS} reinforced insulation working voltage at 5000 meters.
Note:
1. Regulatory Certifications apply to 5 kV _{RMS} rated devices which are production tested to 6.0 kV _{RMS} for 1 sec.
2. Regulatory Certifications apply to 2.5 kV _{RMS} rated devices which are production tested to 3.0 kV _{RMS} for 1 sec.

Table 4.6. Insulation and Safety-Related Specifications

Parameter	Symbol	Test Condition	Value		Unit
			WB Stretched SOIC-8	NB SOIC-8	
Nominal External Air Gap (Clearance)	CLR		8.0	4.0	mm
Nominal External Tracking (Creepage)	CRP		8.0	4.0	mm
Minimum Internal Gap (Internal Clearance)	DTI		36	36	μm
Tracking Resistance	PTI or CTI	IEC60112	600	600	V
Erosion Depth	ED		0.04	0.04	mm
Resistance (Input-Output)	R _{IO}		10 ¹²	10 ¹²	Ω
Capacitance (Input-Output)	C _{IO}	f = 1 MHz	1	1	pF

Note:

1. To determine resistance and capacitance, the Si8935/36/37 is converted into a two-terminal device. Pins 1–4 are shorted together to form the first terminal, and pins 5–8 are shorted together to form the second terminal. The parameters are then measured between these two terminals.

Table 4.7. IEC 60664-1 Ratings

Parameter	Test Conditions	Specification	
		WB Stretched SOIC-8	NB SOIC-8
Basic Isolation Group	Material Group	I	I
Installation Classification	Rated Mains Voltages $\leq 150 V_{RMS}$	I-IV	I-IV
	Rated Mains Voltages $\leq 300 V_{RMS}$	I-IV	I-IV
	Rated Mains Voltages $\leq 600 V_{RMS}$	I-IV	I-III

Table 4.8. IEC 60747-17 Insulation Characteristics¹

Parameter	Symbol	Test Condition	Characteristic		Unit
			WB Stretched SOIC-8	NB SOIC-8	
Maximum Working Isolation Voltage	V_{IORM}		1500	1500	V_{RMS}
Maximum Repetitive Isolation Voltage	V_{IORM}		2121	2121	V_{peak}
Input to Output Test Voltage	V_{PR}	Method b1 ($V_{IORM} \times 1.875 = V_{PR}$, 100% Production Test, $t_m = 1$ sec, Partial Discharge < 5 pC)	3976	3976	V_{peak}
Maximum Transient Isolation Voltage	V_{IOTM}	$t = 60$ sec	8000	4000	V_{peak}
Maximum Surge Isolation Voltage	V_{IOSM}	Test voltage is $\geq 1.3 \times V_{IMP}$, minimum 10000 V_{peak} and $1.2 \mu s/50 \mu s$	10400	10400	V_{peak}
Maximum Impulse Voltage	V_{IMP}		8000	5656	V_{peak}
Pollution Degree		DIN VDE 0110	2	2	
Insulation Resistance	R_S	$T_{AMB} = T_S$, $V_{IO} = 500$ V	$>10^9$	$>10^9$	Ω

Note:

1. This isolator is suitable for reinforced electrical isolation only within the safety limit data. Maintenance of the safety data is ensured by protective circuits. The Si8935/36/37 provides a climate classification of 40/125/21.

4.2 Typical Operating Characteristics

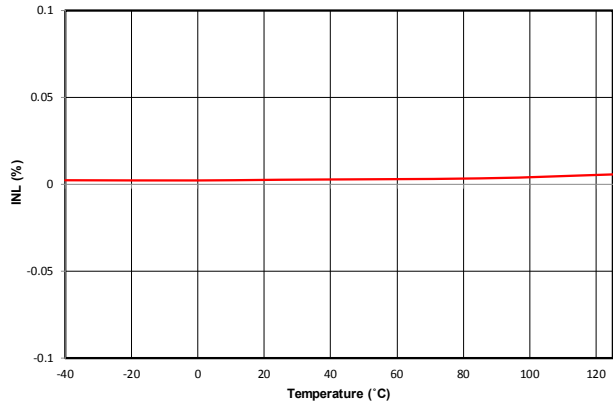

Figure 4.6. Si8935 Nonlinearity (%) vs. Temperature (°C)

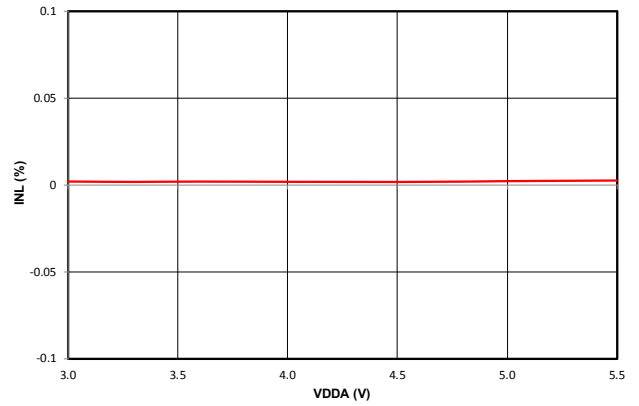

Figure 4.7. Si8935 Nonlinearity (%) vs. VDDA Supply (V)

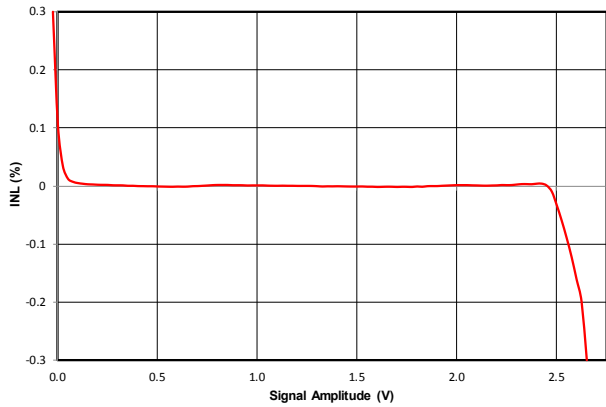

Figure 4.8. Si8935 Nonlinearity (%) vs. Input Signal Amplitude (mV)

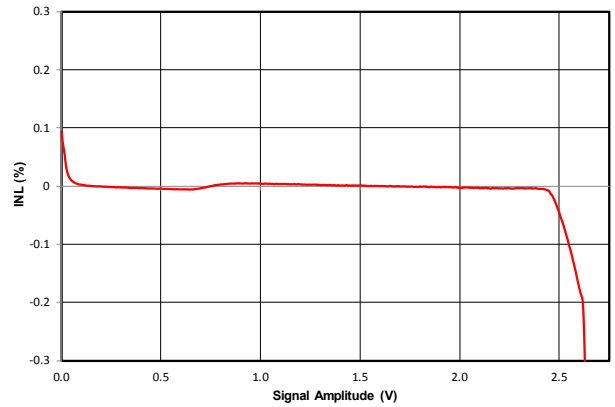

Figure 4.9. Si8936 Nonlinearity (%) vs. Input Signal Amplitude (mV)

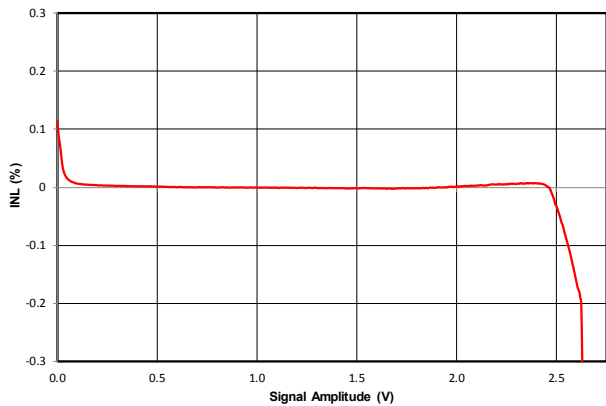

Figure 4.10. Si8937 Nonlinearity (%) vs. Input Signal Amplitude (mV)

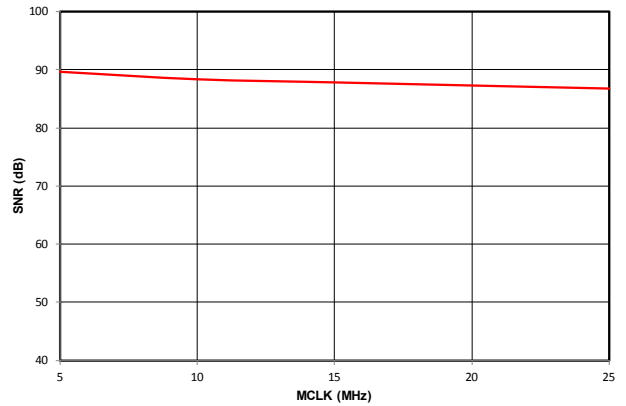

Figure 4.11. Si8935 Signal-to-Noise Ratio (dB) vs. MCLK (MHz)

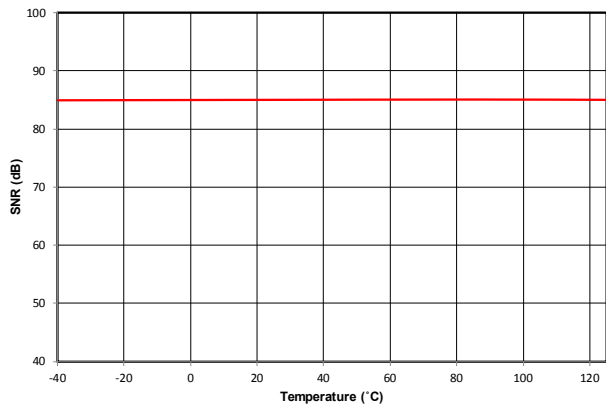

Figure 4.12. Si8935 Signal-to-Noise Ratio (dB) vs. Temperature (°C)

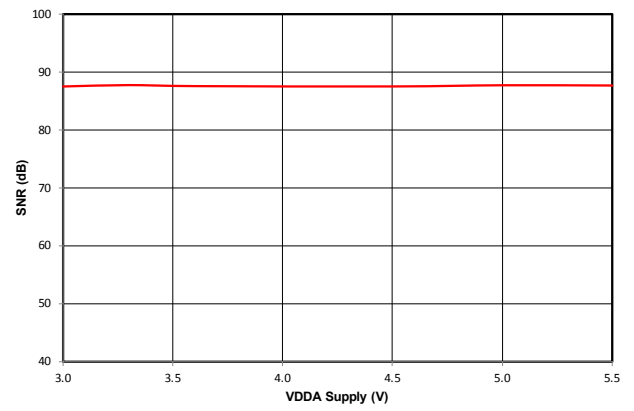

Figure 4.13. Si8935 Signal-to-Noise Ratio (dB) vs. VDDA Supply (V)

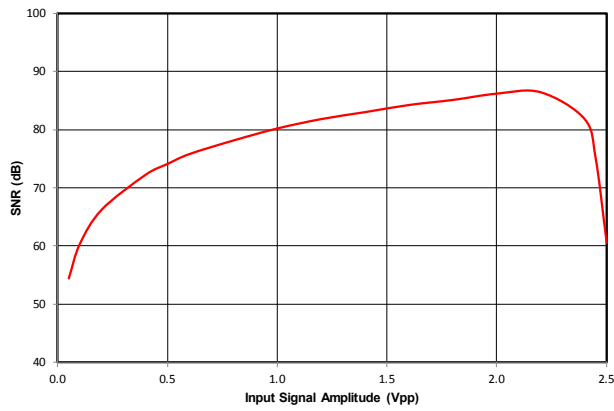

Figure 4.14. Si8935 Signal-to-Noise Ratio (dB) vs. Input Signal Amplitude (mV)

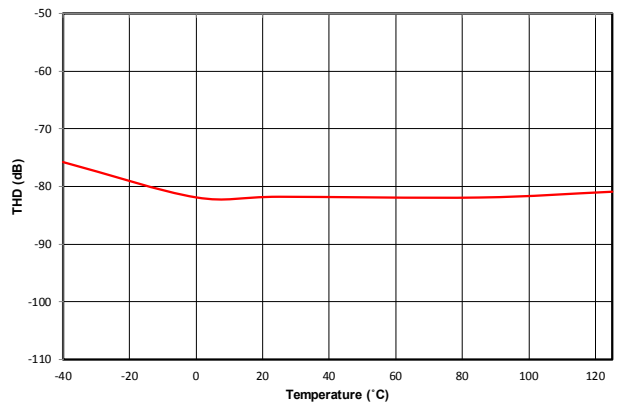

Figure 4.15. Si8935 Total Harmonic Distortion (dB) vs. Temperature (°C)

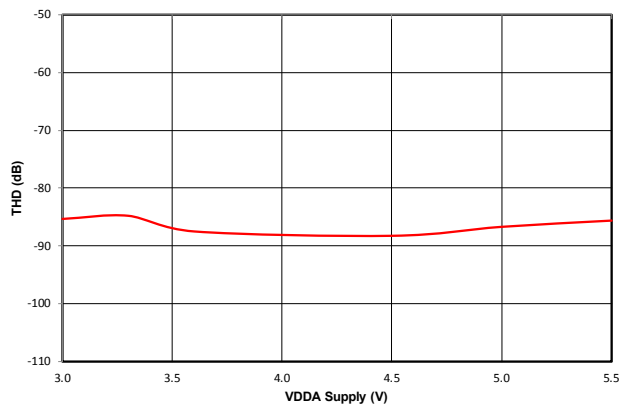

Figure 4.16. Si8935 Total Harmonic Distortion (dB) vs. VDDA Supply (V)

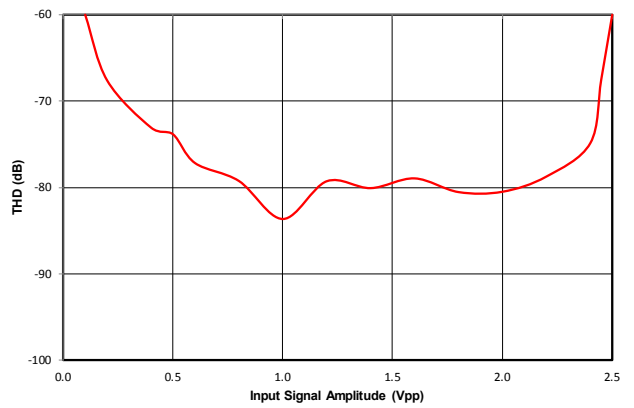

Figure 4.17. Si8935 Total Harmonic Distortion vs. Input Signal Amplitude (mV)

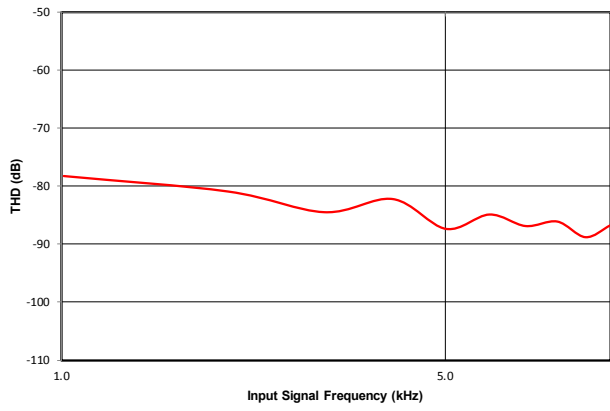

Figure 4.18. Si8935 Total Harmonic Distortion vs. Input Signal Frequency (kHz)

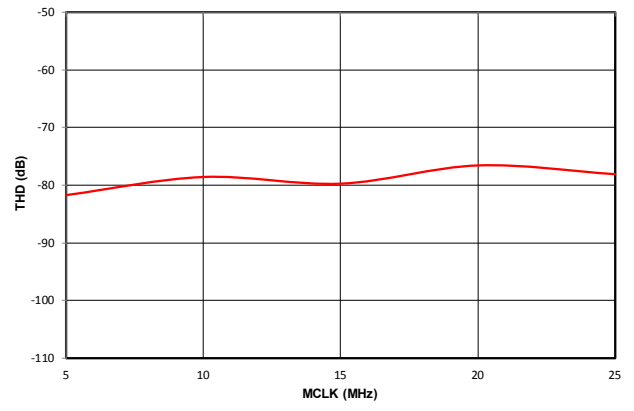

Figure 4.19. Si8935 Total Harmonic Distortion vs. MCLK (MHz)

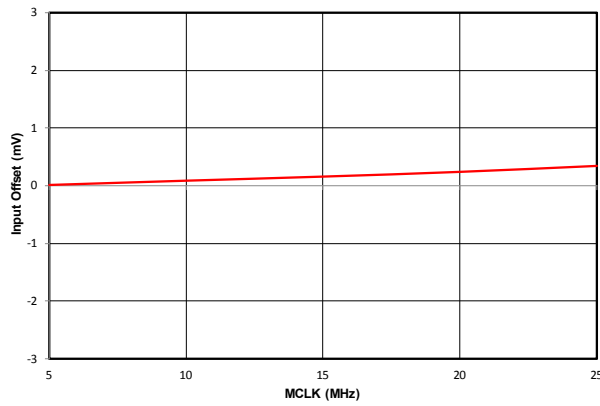

Figure 4.20. Si8935 Input Offset (mV) vs. MCLK (MHz)

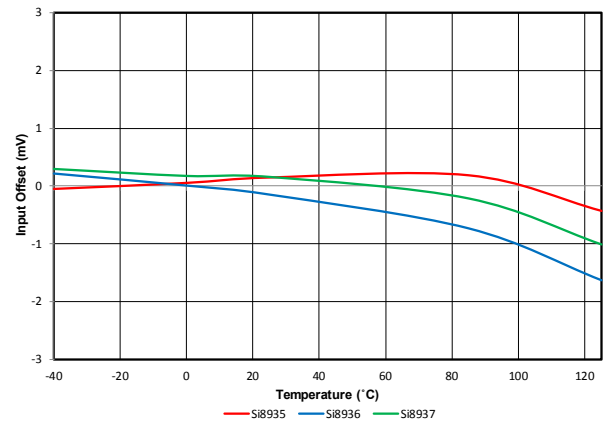

Figure 4.21. Input Offset (mV) vs. Temperature (°C)

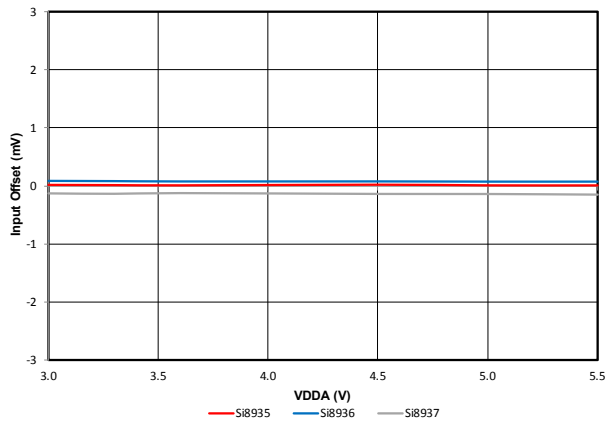

Figure 4.22. Input Offset (mV) vs. VDDA Supply (V)

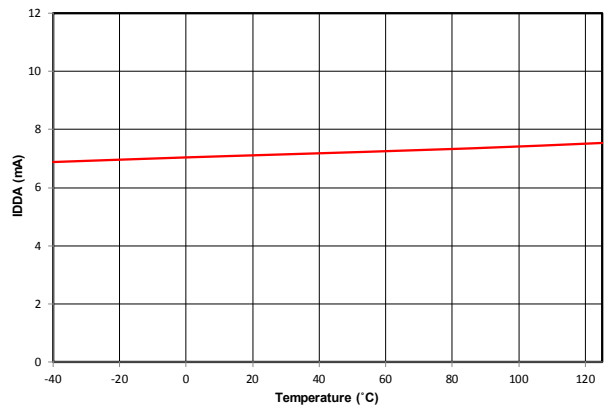

Figure 4.23. Si8935/36/37 IDDA (mA) vs. Temperature (°C)

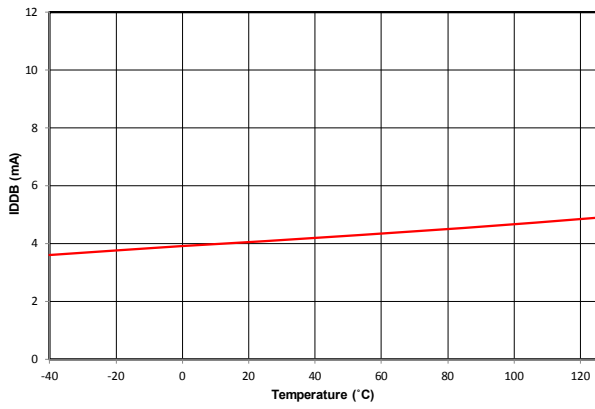

Figure 4.24. Si8935 IDDB (mA) vs. Temperature (C)

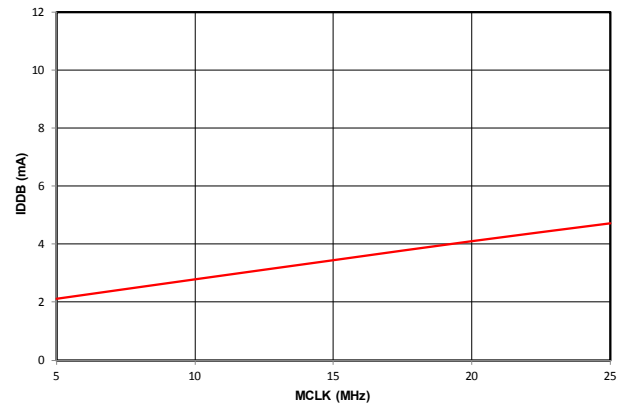

Figure 4.25. Si8935 IDDB (mA) vs. MCLK (MHz)

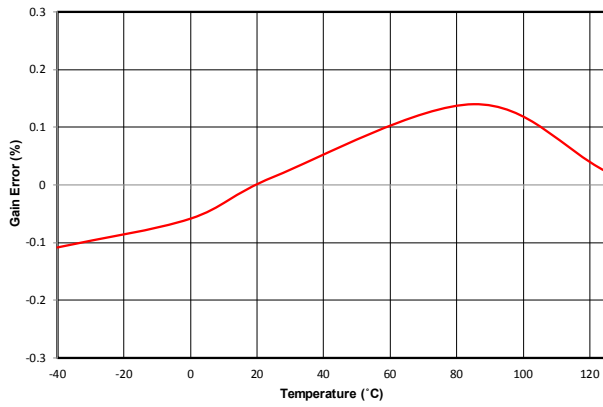

Figure 4.26. Si8935 Gain Error (%) vs. Temperature (C)

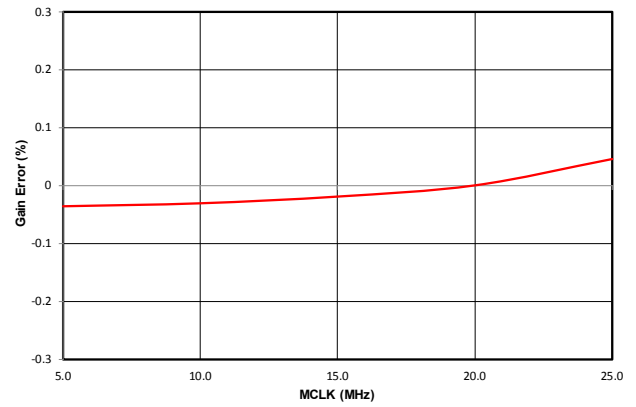

Figure 4.27. Si8935 Gain Error (%) vs. MCLK (MHz)

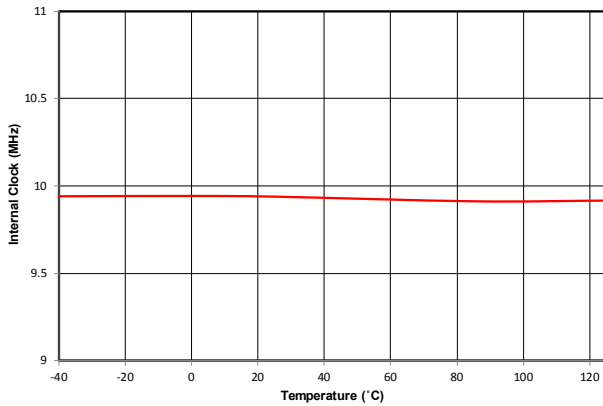

Figure 4.28. Si8936 Internal Clock Frequency (MHz) vs. Temperature (C)

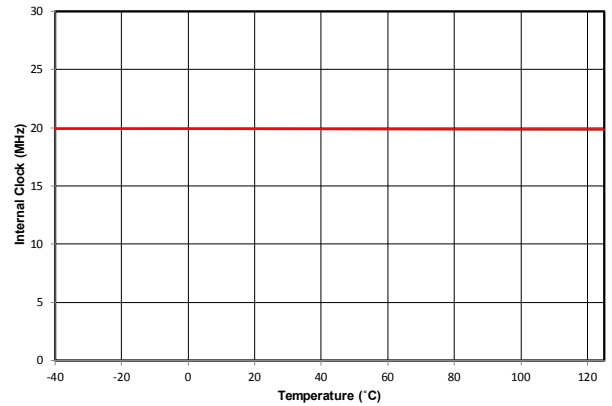

Figure 4.29. Si8937 Internal Clock Frequency (MHz) vs. Temperature (C)

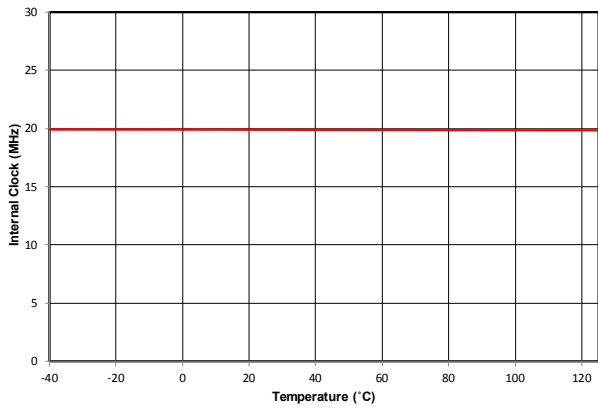

Figure 4.30. Si8935 Power Supply Rejection Ratio (dB) vs. Input Signal Frequency (kHz)

5. Pin Descriptions

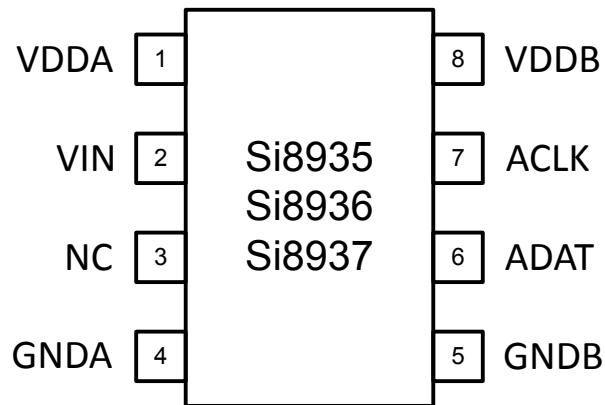

Table 5.1. Si8935/36/37 Pin Descriptions

Name	Pin #	Description
VDDA	1	Input side power supply
VIN	2	Voltage input
NC ¹	3	No Connect
GNDA	4	Input side ground
GNDB	5	Output side ground
ADAT	6	Delta-sigma modulator data output
ACLK	7	Delta-sigma modulator clock (input on Si8935, output on Si8936/37)
VDDB	8	Output side power supply

Note:

1. No Connect. These pins are not internally connected. To maximize CMTI performance, these pins should be connected to the ground plane.

6. Packaging

6.1 Package Outline: 8-Pin Wide Body Stretched SOIC

The figure below illustrates the package details for the Si8935/36/37 in a 8-Pin Wide Body Stretched SOIC package. The table lists the values for the dimensions shown in the illustration.

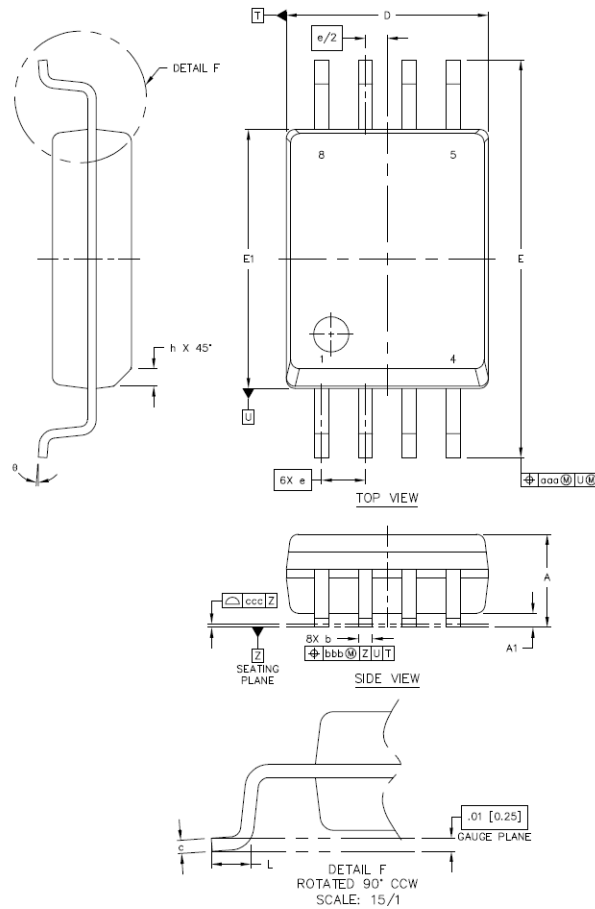

Figure 6.1. 8-Pin Wide Body Stretched SOIC Package

Table 6.1. 8-Pin Wide Body Stretched SOIC Package Diagram Dimensions

Symbol	Millimeters	
	Min	Max
A	2.49	2.79
A1	0.36	0.46
b	0.30	0.51
c	0.20	0.33
D	5.74	5.94
E	11.25	11.76
E1	7.39	7.59
e	1.27 BSC	
L	0.51	1.02
h	0.25	0.76

Symbol	Millimeters	
	Min	Max
θ	0°	8°
aaa	—	0.25
bbb	—	0.25
ccc	—	0.10

Note:

1. All dimensions shown are in millimeters (mm) unless otherwise noted.
2. Dimensioning and Tolerancing per ANSI Y14.5M-1994.
3. Recommended reflow profile per JEDEC J-STD-020C specification for small body, lead-free components.

6.2 Package Outline: 8-Pin Narrow Body SOIC

The figure below illustrates the package details for the Si8935/36/37 in an 8-Pin Narrow Body SOIC package. The table lists the values for the dimensions shown in the illustration.

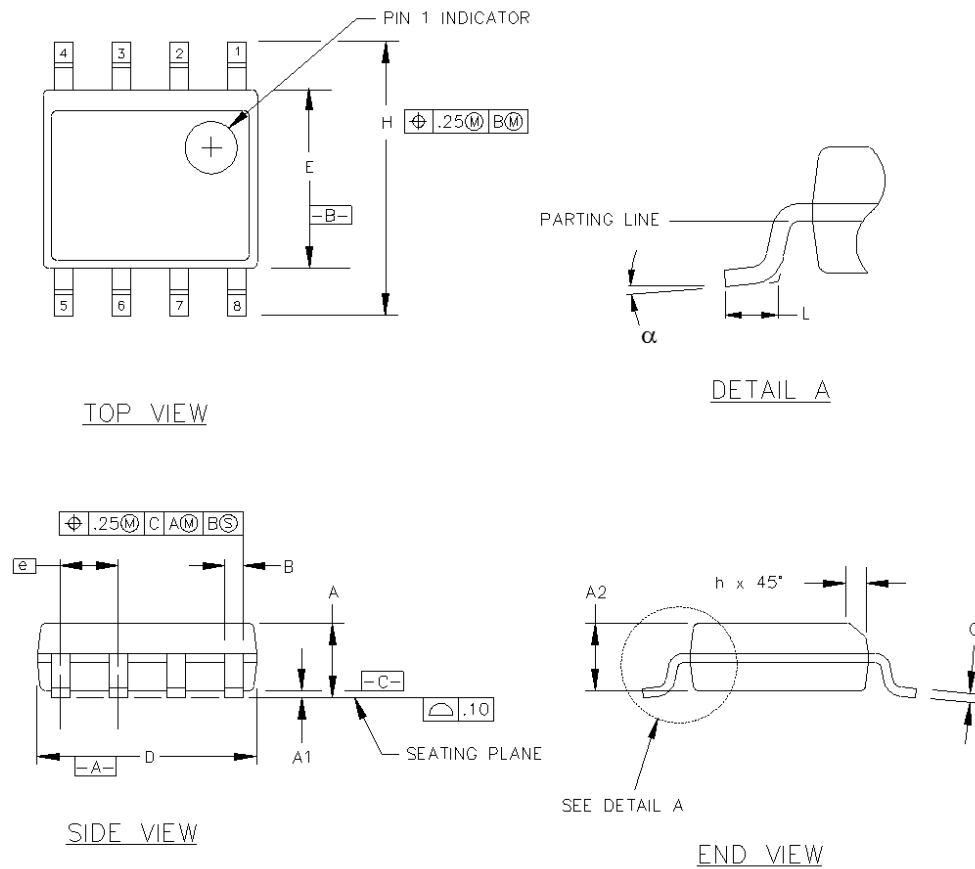

Figure 6.2. 8-Pin Narrow Body SOIC Package

Table 6.2. 8-Pin Narrow Body SOIC Package Diagram Dimensions

Dimension	Min	Max
A	1.35	1.75
A1	0.10	0.25
A2	1.40 REF	1.55 REF
B	0.33	0.51
C	0.19	0.25
D	4.80	5.00
E	3.80	4.00
e	1.27 BSC	
H	5.80	6.20
h	0.25	0.50
L	0.40	1.27
α	0°	8°

Dimension	Min	Max
<p>Note:</p> <ol style="list-style-type: none">1. All dimensions shown are in millimeters (mm) unless otherwise noted.2. Dimensioning and Tolerancing per ANSI Y14.5M-1982.3. This drawing conforms to JEDEC Outline MS-012.4. Recommended card reflow profile is per the JEDEC/IPC J-STD-020B specification for Small Body Components.		

6.3 Land Pattern: 8-Pin Wide Body Stretched SOIC

The figure below illustrates the recommended land pattern details for the Si8935/36/37 in a 8-Pin Wide Body Stretched SOIC package. The table lists the values for the dimensions shown in the illustration.

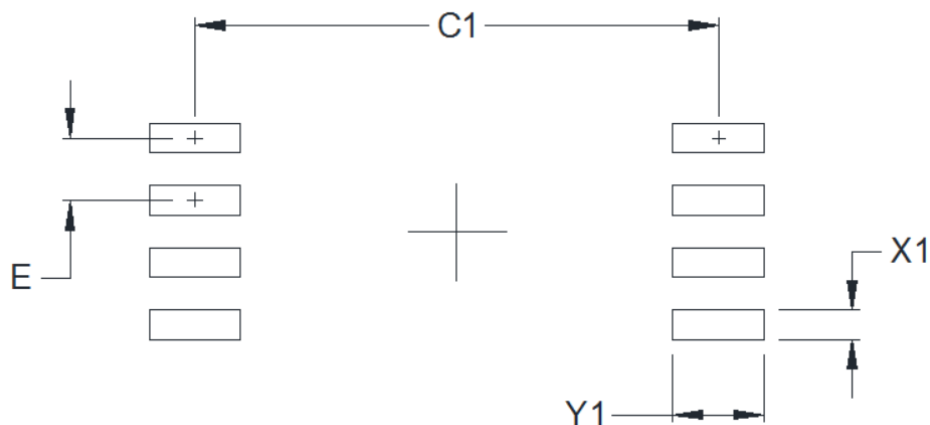

Figure 6.3. 8-Pin Wide Body Stretched SOIC Land Pattern

Table 6.3. 8-Pin Wide Body Stretched SOIC Land Pattern Dimensions¹

Dimension	(mm)
C1	10.60
E	1.27
X1	0.60
Y1	1.85

Note:

General

1. All dimensions shown are at Maximum Material Condition (MMC). Least Material Condition (LMC) is calculated based on a Fabrication Allowance of 0.05 mm.
2. This Land Pattern Design is based on the IPC-7351 guidelines.

Solder Mask Design

1. All metal pads are to be non-solder mask defined (NSMD). Clearance between the solder mask and the metal pad is to be 60 μm minimum, all the way around the pad.

Stencil Design

1. A stainless steel, laser-cut and electro-polished stencil with trapezoidal walls should be used to assure good solder paste release.
2. The stencil thickness should be 0.125 mm (5 mils).
3. The ratio of stencil aperture to land pad size should be 1:1 for all perimeter pins.

Card Assembly

1. A No-Clean, Type-3 solder paste is recommended.
2. The recommended card reflow profile is per the JEDEC/IPC J-STD-020 specification for Small Body Components.

6.4 Land Pattern: 8-Pin Narrow Body SOIC

The figure below illustrates the recommended land pattern details for the Si8935/36/37 in an 8-Pin Narrow Body SOIC package. The table lists the values for the dimensions shown in the illustration.

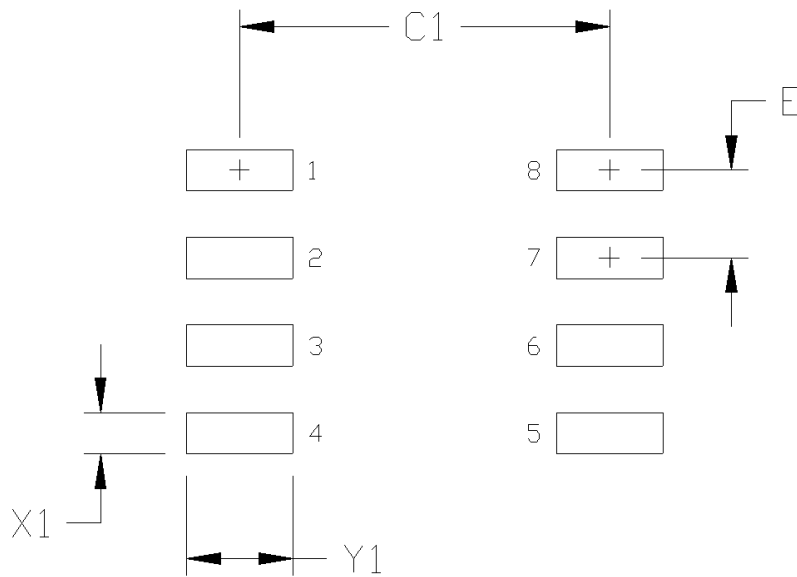

Figure 6.4. 8-Pin Narrow Body SOIC Land Pattern

Table 6.4. 8-Pin Narrow Body SOIC Land Pattern Dimensions

Symbol	mm
C1	5.40
E	1.27
X1	0.60
Y1	1.55

Note:

1. This Land Pattern Design is based on IPC-7351 pattern SOIC127P600X173-8N for Density Level B (Median Land Protrusion).
2. All feature sizes shown are at Maximum Material Condition (MMC) and a card fabrication tolerance of 0.05 mm is assumed.

6.5 Top Marking: 8-Pin Wide Body Stretched SOIC

The figure below illustrates the top markings for the Si8935/36/37 in an 8-Pin Wide Body Stretched SOIC package. The table explains the top marks shown in the illustration.

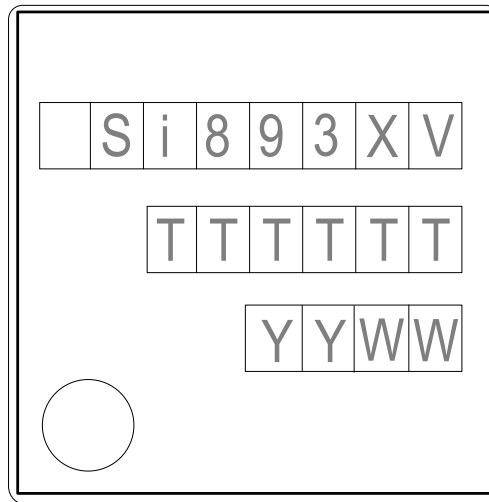

Figure 6.5. Si893x Wide Body Stretched 8-Pin SOIC Top Marking

Table 6.5. Si893x Wide Body Stretched 8-Pin SOIC Top Mark Explanation

Line 1 Marking:	Customer Part Number	Si893X X = Base part number • 5 = External clock • 6 = Internal 10 MHz clock • 7 = Internal 20 MHz clock V = Insulation rating: • D = 5.0 kVrms
Line 2 Marking:	TTTTTT = Mfg Code	Manufacturing Code from the Assembly Purchase Order form.
Line 3 Marking:	YY = Year WW = Work Week Circle = 43 mils Diameter Left-Justified	Assigned by the Assembly House. Corresponds to the year and work week of the mold date.

6.6 Top Marking: 8-Pin Narrow Body SOIC

The figure below illustrates the top markings for the Si8935/36/37 in an 8-Pin Narrow Body SOIC package. The table explains the top marks shown in the illustration.

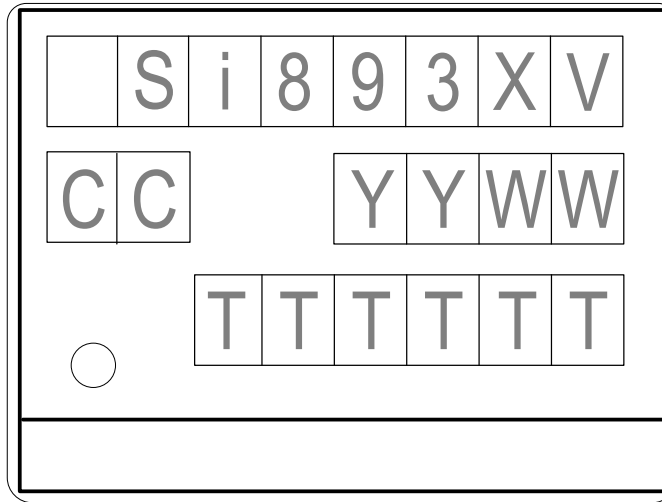

Figure 6.6. 8-Pin Narrow Body SOIC Top Marking

Table 6.6. 8-Pin Narrow Body SOIC Top Marking Explanation

Line 1 Marking:	Customer Part Number	Si893X X = Base part number <ul style="list-style-type: none"> • 5 = External clock • 6 = Internal 10 MHz clock • 7 = Internal 20 MHz clock V = Insulation rating: <ul style="list-style-type: none"> • B = 2.5 kVrms
Line 2 Marking:	CC = Country of Origin ISO Code Abbreviation YY = Year WW = Work Week	Assigned by the Assembly House. Corresponds to the year and work week of the mold date.
Line 3 Marking:	TTTTTT = Mfg Code Circle = 19.7 mils Diameter Left-Justified	Manufacturing Code from the Assembly Purchase Order form.

7. Revision History

Revision 206440A

December, 2022

- Updated decimal-based revision number to alphanumeric code.

Revision 0.8

September, 2022

- Updated Safety Approvals on front page.
- Updated minimum supply currents in [4. Electrical Specifications](#).
- Updated [4.1 Regulatory Information](#).

Revision 0.7

April, 2021

- Updated Applications and Key Features on front page.
- Added Automotive OPNs to [1. Ordering Guide](#).
- Updated [Table 4.6 Insulation and Safety-Related Specifications on page 13](#).
- Updated [4. Electrical Specifications](#) after full characterization.
- Updated narrow body top marking.
- Numerous clarifications throughout.

Revision 0.1

March, 2019

- Initial release.



**Connecting Everyone
and Everything,
All the Time**



Portfolio

skyworksinc.com

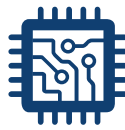

Quality

skyworksinc.com/quality



Support & Resources

skyworksinc.com/support

Copyright © 2022 Skyworks Solutions, Inc. All Rights Reserved.

Information in this document is provided in connection with Skyworks Solutions, Inc. ("Skyworks") products or services. These materials, including the information contained herein, are provided by Skyworks as a service to its customers and may be used for informational purposes only by the customer. Skyworks assumes no responsibility for errors or omissions in these materials or the information contained herein. Skyworks may change its documentation, products, services, specifications or product descriptions at any time, without notice. Skyworks makes no commitment to update the materials or information and shall have no responsibility whatsoever for conflicts, incompatibilities, or other difficulties arising from any future changes.

No license, whether express, implied, by estoppel or otherwise, is granted to any intellectual property rights by this document. Skyworks assumes no liability for any materials, products or information provided hereunder, including the sale, distribution, reproduction or use of Skyworks products, information or materials, except as may be provided in Skyworks' Terms and Conditions of Sale.

THE MATERIALS, PRODUCTS AND INFORMATION ARE PROVIDED "AS IS" WITHOUT WARRANTY OF ANY KIND, WHETHER EXPRESS, IMPLIED, STATUTORY, OR OTHERWISE, INCLUDING FITNESS FOR A PARTICULAR PURPOSE OR USE, MERCHANTABILITY, PERFORMANCE, QUALITY OR NON-INFRINGEMENT OF ANY INTELLECTUAL PROPERTY RIGHT; ALL SUCH WARRANTIES ARE HEREBY EXPRESSLY DISCLAIMED. SKYWORKS DOES NOT WARRANT THE ACCURACY OR COMPLETENESS OF THE INFORMATION, TEXT, GRAPHICS OR OTHER ITEMS CONTAINED WITHIN THESE MATERIALS. SKYWORKS SHALL NOT BE LIABLE FOR ANY DAMAGES, INCLUDING BUT NOT LIMITED TO ANY SPECIAL, INDIRECT, INCIDENTAL, STATUTORY, OR CONSEQUENTIAL DAMAGES, INCLUDING WITHOUT LIMITATION, LOST REVENUES OR LOST PROFITS THAT MAY RESULT FROM THE USE OF THE MATERIALS OR INFORMATION, WHETHER OR NOT THE RECIPIENT OF MATERIALS HAS BEEN ADVISED OF THE POSSIBILITY OF SUCH DAMAGE.

Skyworks products are not intended for use in medical, lifesaving or life-sustaining applications, or other equipment in which the failure of the Skyworks products could lead to personal injury, death, physical or environmental damage. Skyworks customers using or selling Skyworks products for use in such applications do so at their own risk and agree to fully indemnify Skyworks for any damages resulting from such improper use or sale.

Customers are responsible for their products and applications using Skyworks products, which may deviate from published specifications as a result of design defects, errors, or operation of products outside of published parameters or design specifications. Customers should include design and operating safeguards to minimize these and other risks. Skyworks assumes no liability for applications assistance, customer product design, or damage to any equipment resulting from the use of Skyworks products outside of Skyworks' published specifications or parameters.

Skyworks, the Skyworks symbol, Sky5®, SkyOne®, SkyBlue™, Skyworks Green™, ClockBuilder®, DSPLL®, ISOmodem®, ProSLIC®, and SiPHY® are trademarks or registered trademarks of Skyworks Solutions, Inc. or its subsidiaries in the United States and other countries. Third-party brands and names are for identification purposes only and are the property of their respective owners. Additional information, including relevant terms and conditions, posted at www.skyworksinc.com, are incorporated by reference.

Skyworks Solutions, Inc. | Nasdaq: SWKS | sales@skyworksinc.com | www.skyworksinc.com

USA: 781-376-3000 | Asia: 886-2-2735 0399 | Europe: 33 (0)1 43548540