

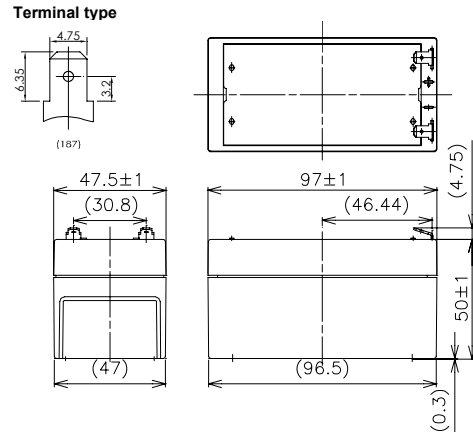

※Contents indicated (including the recycle marking, etc) are subject to change without notice.

■Dimensions(mm)



Battery case resin: standard(UL94HB)

■Specification

Nominal Voltage	12V	
Rated Capacity(20HR)	1.3Ah	
Dimensions	Length	97 mm
	Width	47.5 mm
	Height	50 mm
	Total height	55 mm
Approx. Mass	0.55 kg	
Terminal	Faston 187	

■Characteristics

Capacity (25 °C)	20 hour rate	1.3Ah
	10 hour rate	1.1Ah
	3 hour rate	1.0Ah
	1 hour rate	0.88Ah
Internal Resistance (25 °C)	Fully charged battery	90 mΩ
Temperature Dependency of Capacity (20 hour rate)	40 °C	102%
	25 °C	100%
	0 °C	85%
	-15 °C	65%
Self Discharge (25 °C)	After 3 months	91%
	After 6 months	82%
	After 12 months	64%

■Duration of discharge vs. discharge current

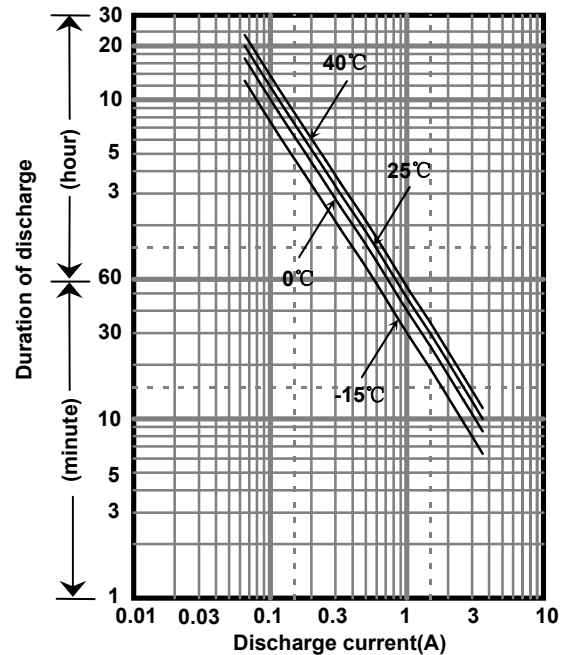

■Watt Table(25°C)

Cut-off V	(Wattage/Battery)															
	3min	5min	10min	15min	20min	30min	45min	1h	1.5h	2h	3h	4h	5h	6h	10h	20h
9.6V	78.1	61.6	40.2	30.7	25.8	19.2	13.6	10.8	7.49	5.73	4.32	3.30	2.73	2.22	1.46	0.787
9.9V	72.5	57.8	39.4	30.5	25.3	19.0	13.5	10.7	7.34	5.68	4.30	3.28	2.70	2.21	1.45	0.784
10.2V	66.9	54.2	38.4	29.9	24.9	18.8	13.4	10.6	7.19	5.54	4.25	3.26	2.68	2.19	1.44	0.782
10.5V	59.4	48.5	35.6	27.8	23.7	18.4	13.1	10.4	7.04	5.34	4.19	3.25	2.66	2.17	1.43	0.780
10.8V	50.2	42.9	31.7	26.0	23.0	17.7	12.9	10.2	6.82	5.13	4.08	3.24	2.60	2.16	1.41	0.758

■Ampere Table(25°C)

Cut-off V	(Ampere/Battery)															
	3min	5min	10min	15min	20min	30min	45min	1h	1.5h	2h	3h	4h	5h	6h	10h	20h
9.6V	7.02	5.53	3.59	2.67	2.22	1.64	1.16	0.921	0.634	0.484	0.363	0.276	0.228	0.185	0.122	0.0655
9.9V	6.52	5.18	3.52	2.65	2.18	1.63	1.15	0.912	0.621	0.480	0.361	0.274	0.226	0.184	0.121	0.0654
10.2V	6.01	4.86	3.43	2.60	2.15	1.61	1.14	0.903	0.609	0.468	0.358	0.273	0.224	0.183	0.120	0.0652
10.5V	5.34	4.35	3.18	2.42	2.04	1.57	1.12	0.885	0.596	0.451	0.352	0.272	0.222	0.182	0.119	0.0650
10.8V	4.51	3.85	2.83	2.26	1.99	1.52	1.10	0.867	0.578	0.433	0.343	0.271	0.217	0.181	0.117	0.0632

Charging Method (25°C)

Cycle use	Control voltage: 14.5-14.9V Initial current: 0.520A or smaller
-----------	---

Cut off voltage

Discharge current	0.0650A-0.260A	0.260A-0.650A	0.650A-1.30A	1.30A-2.60A	2.60A-3.90A
Cut off voltage(V)	10.5	10.2	9.9	9.3	8.7

Cycle life vs. Depth of discharge

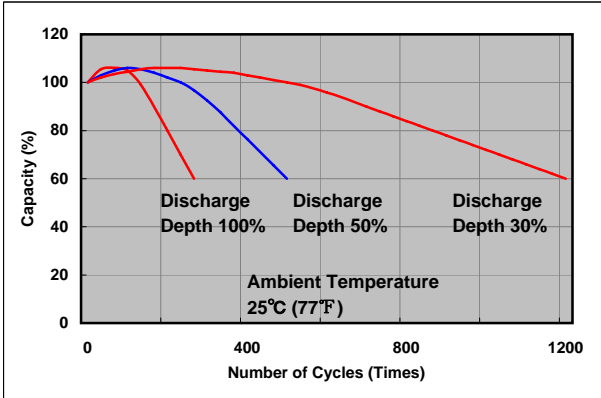

Residual capacity test result

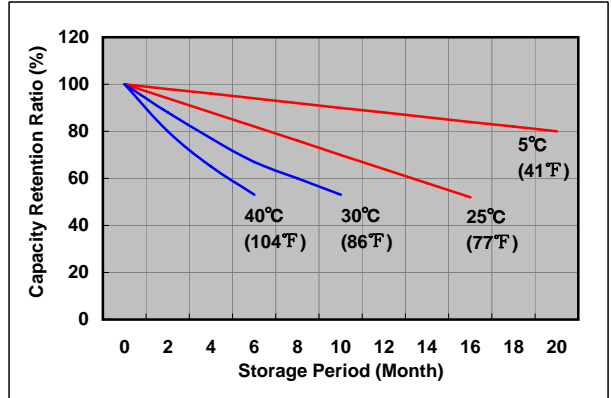

Constant-voltage constant-current charge characteristics for Cycle use

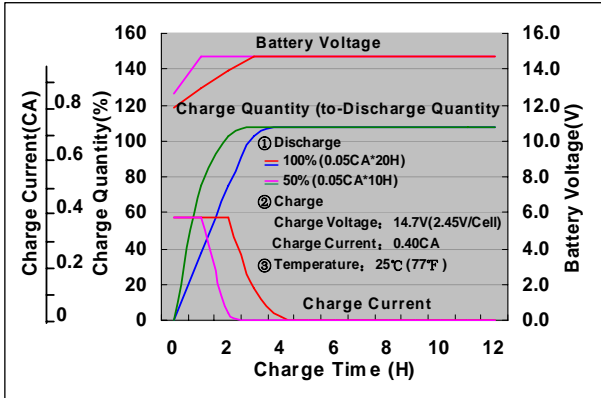

Discharge capacity by temperature and by discharge current

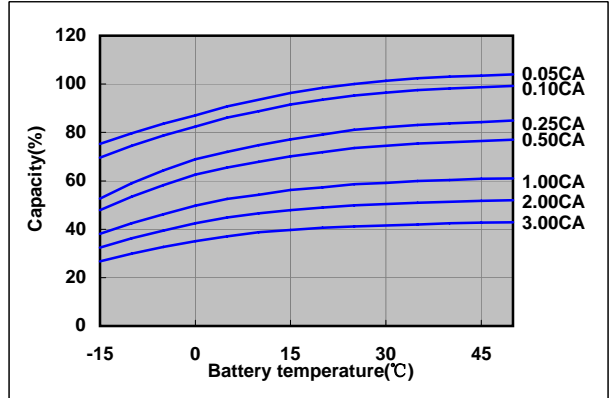

Discharge characteristics(25°C)

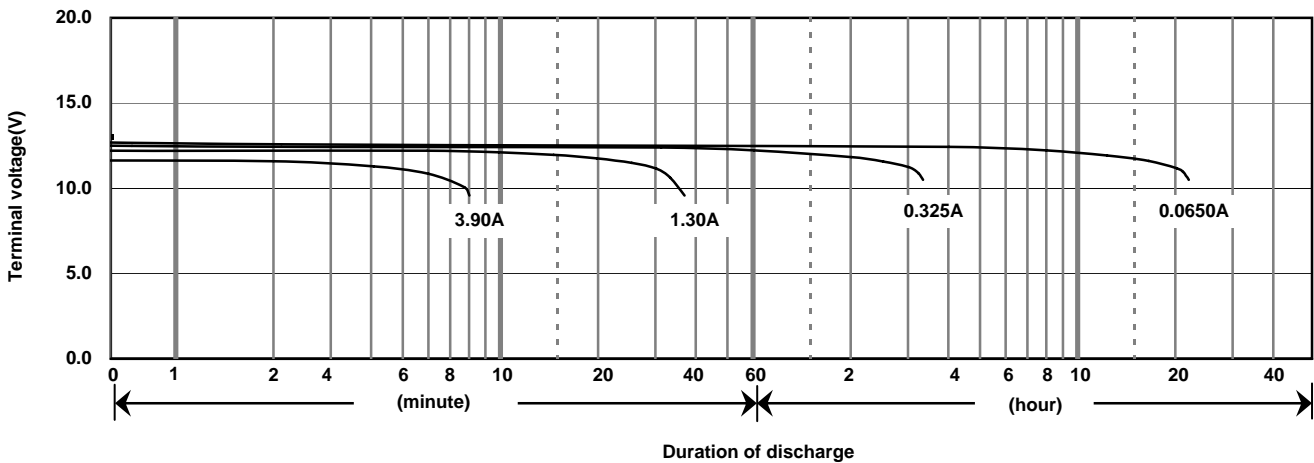

Caution

Due to the potential energy stored in the batteries, Please read 《Precautions for handling the Rechargeable Valve Regulated Lead Acid Batteries》 before using batteries. If improper handling or use of the batteries without understanding 《Precautions for handling the Rechargeable Valve Regulated Lead Acid Batteries》 may result in bodily injury caused by electrolyte leakage, heat generation, or explosion.

Panasonic Storage Battery (Shenyang) Co., Ltd

NO. 51 Kunminghu Street, Shenyang Economic & Technical Development Zone, 110141 China

Tel: 86 24 25818921

Fax: 86 24 62786318

Website: <http://www.panasonicbattery.cn>

2010.03