

40DAW_1.5 Series

40W - Single/Dual Output - Wide Input - Isolated & Regulated
DIP DC-DC Converter

DC-DC Converter

40 Watt

- ⊕ High efficiency up to 91%
- ⊕ 2:1 wide input voltage range
- ⊕ Isolation voltage 1500VDC
- ⊕ Six-sided metal shield
- ⊕ Short circuit protection (SCP) (automatic recovery)
- ⊕ Operating temperature: -40°C to +85°C
- ⊕ Over temperature protection
- ⊕ Industry standard pinout
- ⊕ Under voltage lockout

The 40DAW_1.5 series offers 40W of output, wide input voltage of 9-18VDC, 18-36VDC, 36-75VDC and features 1500VDC isolation, six-sided metal shield over current and short circuit protection.

All models are particularly suited to tele-communications, industrial, test equipments power etc.



Common specifications	
Cooling:	Free air convection
Short circuit protection:	Continuous, auto-recovery
Operation temperature range:	-40°C~+85°C
Storage temperature range:	-55°C~+125°C
Case temperature:	105°C
Thermal shutdown:	105°C TYP
Lead temperature range:	265°C MAX, 1.5mm from case for 10 sec
Switching frequency (PWM mode):	350kHz TYP
Humidity:	non-condensing, 95% MAX
Case material:	Metal
Potting material:	Epoxy (UL94V-0 rated)
MTBF (MIL-HDBK-217F @25°C)*:	≥328,000 hours
Weight:	30g

* BELLCORE TR-NWT-000332. Case I: 50% Stress, Temperature at 40°C. (Ground fixed and controlled environment)

Input specifications					
Item	Test condition	Min	Typ	Max	Units
Start-up voltage / under voltage lockout	• 12Vin		9/8		VDC
	• 24Vin		17.8/15.8		VDC
	• 48Vin		36/33		VDC
Surge voltage	100ms max.				
	• 12Vin			25	V
	• 24Vin			50	V
	• 48Vin			100	V
Conducted noise*	EN 55022 level A, FCC part 15, level A with external capacitor				
Filter	Pi type				

* The 40DAW_1.5 series can meet EN55022 Class A with parallel an external capacitor to the input pins. Recommend:
12Vin: 10µF/25V X7R 1812 MLCC
24Vin: 4.7µF/50V X7R 1812 MLCC.
48Vin: 2.2µF/100V X7R 1812 MLCC.

Isolation specifications					
Item	Test condition	Min	Typ	Max	Units
Isolation voltage	Input/Output, tested for 1 minute and 1mA max			1500	VDC
Isolation resistance	Test at 500VDC	1000			MΩ
Isolation capacitance	Input/Output, 100KHz/0.1V			1500	pF

Output specifications						
Item	Test condition	Min	Typ	Max	Units	
Voltage tolerance				±2	%	
Output voltage adjustment	only for single output models			±10	%	
Line regulation	Vin min to Vin max, F.L			±0.5	%	
Load regulation	10% to 100% load • Single output • Dual output			±0.5	%	
				±2	%	
Cross variation	25% / 100% (Dual output)			±5	%	
Ripple and noise ¹⁾	20MHz Bandwidth			100	mV	
Start-up time	nominal Vin and constant resistive load		25		ms	
Transient response time	25% load step change		300		µs	
Over load protection	Input voltage range			150	%Io	
Over voltage protection	• 3.3VDC		3.9		V	
	• 5VDC		6.2		V	
	• 12VDC		15		V	
	• 15VDC		18		V	
Remote ON/OFF ²⁾	• ON		Open			
	• OFF		Short to ground			
	• Off idle current			2.5	mA	

1) Test ripple and noise by "parallel cable" method. Typical value at nominal input voltage and no load.

2) The ON/OFF control pin voltage is referenced to -Input. (Leave open if not used.)

Model selection:

WCTV_xxyyN##

W= Watt; C=Case; T= Type; V= Voltage Variation (omitted ± 10%);
xx= Vin; yy= Vout; N= Numbers of Output; ##= Isolation (kVDC)

Example:

40DAW_2415S1.5

40= 40Watt; D= DIP; A= series; W= wide input (2:1) 18-36Vin;
15Vout; S= single output; 1.5= 1500VDC

Note:

1. Input voltage can't exceed this value, or will cause the permanent damage.
2. The load shouldn't be less than 5%, otherwise ripple will increase dramatically.
3. Max. Capacitive Load is tested on Vin-nominal and full load.
4. All specifications measured at Ta=25°C, humidity<75%, nominal input voltage and rated output load unless otherwise specified.
5. In this datasheet, all the test methods of indications are based on corporate standards.
6. Only typical models listed, other models may be different, please contact our technical person for more details.
7. Specifications subject to change without notice.

40DAW_1.5 Series

40W - Single/Dual Output - Wide Input - Isolated & Regulated
DIP DC-DC Converter

Part Number	Input Voltage Range [VDC]	Input current [mA, typ]		Output Voltage [VDC]	Output Current [mA]	Efficiency [%, Typ.]	Capacitive load* [μF, max.]
		no load	full load				
40DAW_1203S1.5	9-18	120	2471	3.3	8000	89	16000
40DAW_1205S1.5	9-18	160	3745	5	8000	89	10000
40DAW_1212S1.5	9-18	60	3752	12	3340	89	1800
40DAW_1215S1.5	9-18	60	3708	15	2670	90	1200
40DAW_2403S1.5	18-36	85	1235	3.3	8000	89	16000
40DAW_2405S1.5	18-36	90	1851	5	8000	90	10000
40DAW_2412S1.5	18-36	50	1855	12	3340	90	1800
40DAW_2415S1.5	18-36	50	1833	15	2670	91	1200
40DAW_2424S1.5	18-36	50	1824	24	1670	89	1000
40DAW_4803S1.5	36-75	55	611	3.3	8000	90	16000
40DAW_4805S1.5	36-75	70	925	5	8000	90	10000
40DAW_4812S1.5	36-75	30	917	12	3340	91	1800
40DAW_4815S1.5	36-75	30	916	15	2670	91	1200
40DAW_4824S1.5	36-75	50	904	24	1670	89	1000
40DAW_1212D1.5	9-18	60	3795	±12	±1670	88	±1000
40DAW_1215D1.5	9-18	60	3806	±15	±1340	88	±680
40DAW_2412D1.5	18-36	50	1876	±12	±1670	89	±1000
40DAW_2415D1.5	18-36	50	1882	±15	±1340	89	±680
40DAW_4812D1.5	36-75	40	938	±12	±1670	89	±1000
40DAW_4815D1.5	36-75	40	941	±15	±1340	89	±680

* Test by normal Vin and constant resistive load.

Typical characteristics

Temperature derating graph

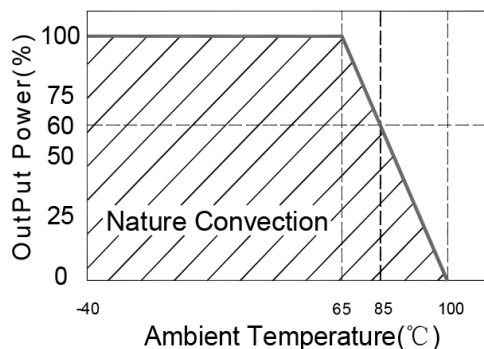

External output trimming

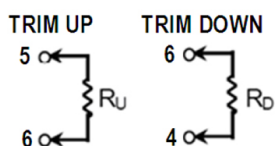

Output can be externally trimmed by using the method shown above.

Output voltage adjustment

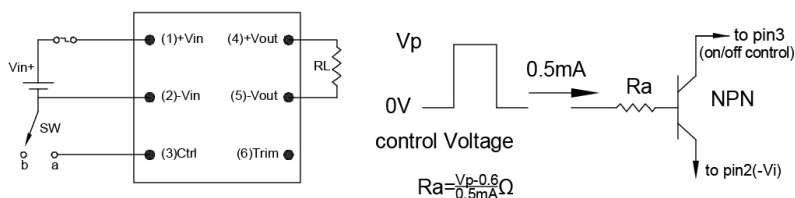

When pin3 short to pin2, D/D ON => OFF
When pin3 leave open, D/D => ON

Suggest Circuit:

40DAW_1.5 Series

40W - Single/Dual Output - Wide Input - Isolated & Regulated
DIP DC-DC Converter

EMC considerations

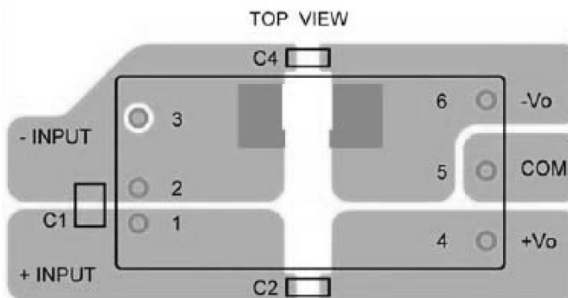
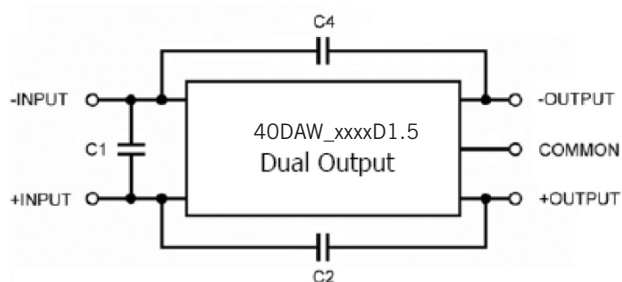
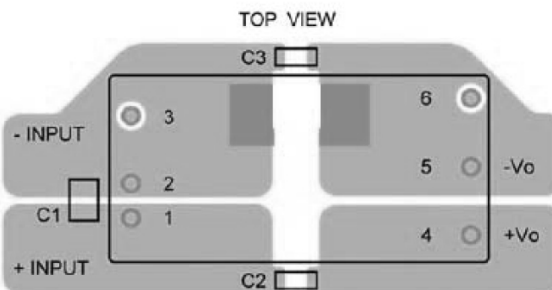
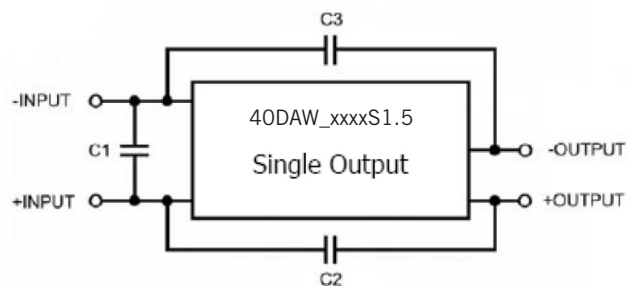

Suggested Schematic to comply with Conducted Noise according to EN55022 Class A

Recommended Layout with input Filter

Following components are needed to comply with EN55022 Class A conducted noise:

40DAW_12xxS

Component	Value	Voltage	Reference
C1	10 μ F	25V	1812 MLCC
C2, C3	1000pF	2KV	1808 MLCC

40DAW_12xxD

Component	Value	Voltage	Reference
C1	10 μ F	25V	1812 MLCC
C2, C4	1000pF	2KV	1808 MLCC

40DAW_24xxS

Component	Value	Voltage	Reference
C1	4.7 μ F	50V	1812 MLCC
C2, C3	1000pF	2KV	1808 MLCC

40DAW_24xxD

Component	Value	Voltage	Reference
C1	4.7 μ F	50V	1812 MLCC
C2, C4	1000pF	2KV	1808 MLCC

40DAW_48xxS

Component	Value	Voltage	Reference
C1	2.2 μ F	100V	1812 MLCC
C2, C3	1000pF	2KV	1808 MLCC

40DAW_48xxD

Component	Value	Voltage	Reference
C1	2.2 μ F	100V	1812 MLCC
C2, C4	1000pF	2KV	1808 MLCC

40DAW_1.5 Series

40W - Single/Dual Output - Wide Input - Isolated & Regulated
DIP DC-DC Converter

Mechanical dimensions

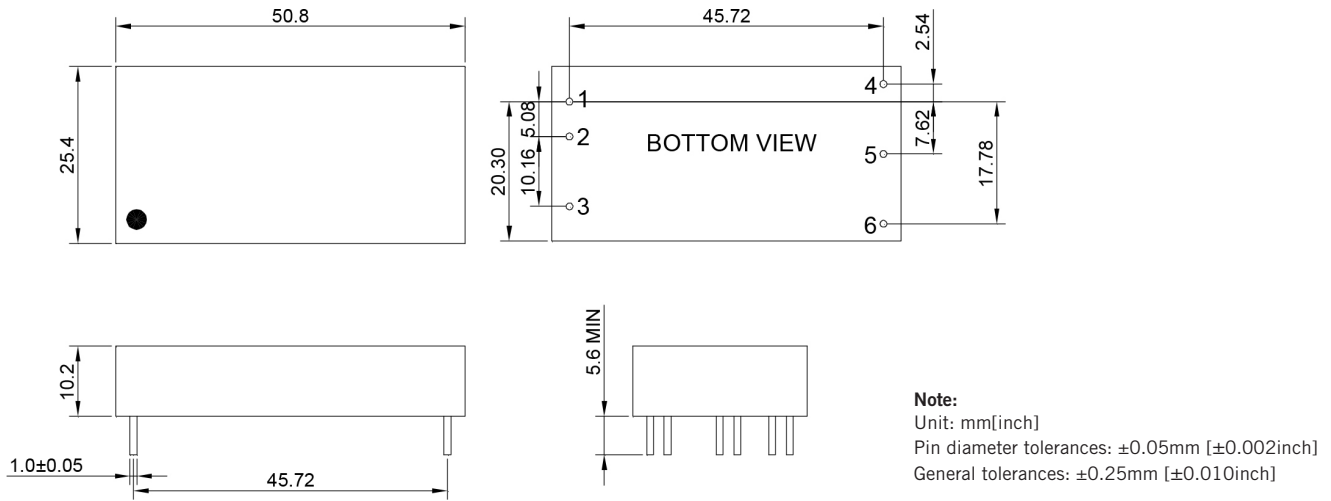

PIN connection

PIN	1	2	3	4	5	6
Single	+Vin	-Vin	Remote On/Off	+Vout	-Vout	Trim
Dual	+Vin	-Vin	Remote On/Off	+Vout	COM	-Vout