



Comair Rotron Specification Sheet

Specification Date: Nov 30, 2017

Version: 03

COMAIR ROTRON PART NUMBER: 19040965A
COMAIR ROTRON MODEL NUMBER: DDE114948K1E

A.) MOTOR:

RATED VOLTAGE:	48 Vdc
OPERATING VOLTAGE RANGE:	36 Vdc – 60 Vdc
LOW-START VOLTAGE:	36 Vdc
RUNNING CURRENT:	2.6 Amps
LOCKED ROTOR CURRENT:	4.0 Amps
RATED POWER:	125 Watts
NOMINAL SPEED:	1900 RPM (At Free Delivery)
START UP TIME:	8 Seconds Maximum
MOTOR TYPE:	Brushless DC
MOTOR PROTECTION:	By Integrated Circuit, Fuse
LOCKED ROTORT PROTECTION:	Electronic
POLARITY PROTECTION:	Yes
AUTOMATIC RESTART CAPABILITY:	By Integrated Circuit
ROTATION:	Clockwise when viewed from Inlet

B.) MECHANICAL

DIMENSIONS:	281mm Dia. x 125mm (11.0" Dia. x 4.90") <i>Figure 1</i>
WEIGHT:	2.50 Kg (5.52 Lbs.)
BEARING TYPE:	Ball Bearing, Permanently Lubricated, Shielded
MOTOR BASE:	Die Cast Aluminum
PROPELLER:	Metal, plated



Comair Rotron Specification Sheet

Specification Date: Nov 30, 2017

Version: 03

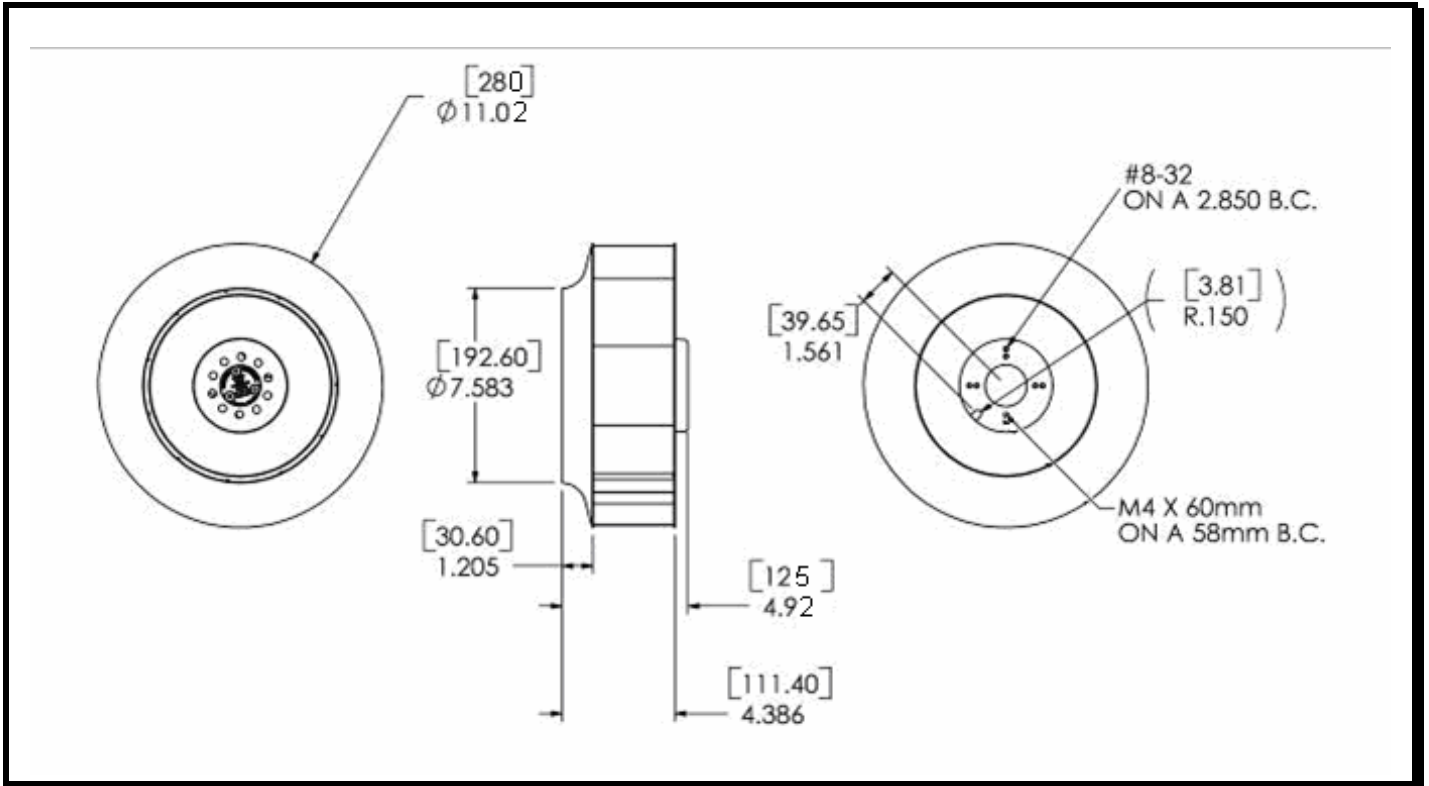

Figure 1

C.) ADDITIONAL FEATURES

TACHOMETER OUTPUT:

Open Collector
 $I_C = 10 \text{ mA. Max.}$
 Pulses per Revolution: 3
 Isolated: No

D.) SPEED CONTROL

Voltage:
 Response:

0~10V
 <1V or open ctrl lead, off
 1V, start
 1~9V, linear ramp
 >9V, full speed

E.) ENVIRONMENTAL

OPERATING TEMPERATURE:

-10°C to +70°C

STORAGE TEMPERATURE:

-40°C to +85° C, 65% ± 20% RH

HUMIDITY:

5% to 95% RH, non-condensing

VIBRATION:

3G's (20 to 200 Hz)



Comair Rotron Specification Sheet

Specification Date: Nov 30, 2017

Version: 03

E.) PERFORMANCE CHARACTERISTICS

AIR FLOW: 1070 CFM \pm 10%
(Measuring at zero static pressure)

STATIC PRESSURE: 1.86" Inches of H₂O
(Measuring at zero air flow)

ACOUSTIC LEVEL: 78.0 dBA
(Freely Suspended at 1 meter per ANSI S12.11-1987)

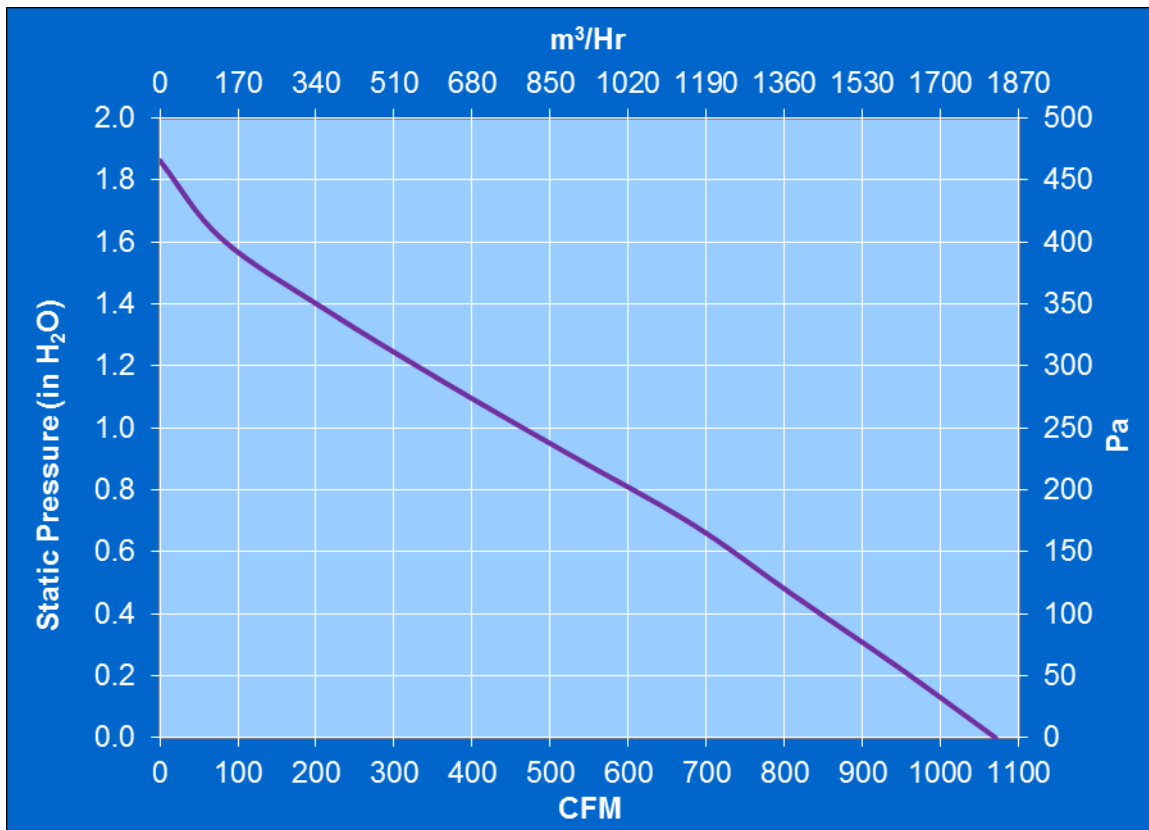

Figure 2



Comair Rotron Specification Sheet

Specification Date: Nov 30, 2017

Version: 03

F.) TERMINATION

HARNESS:

457.2mm \pm 25.4mm (18" \pm 1")
18 AWG, UL 1007 Style
(From the edge of the motor base to the tip
of the connector.)
Connector: Molex 39-01-2040
Terminals: Molex 39-00-0059

COLOR DESIGNATION:

Red	= Power (+)
Black	= Return (-)
Blue/White	= Tachometer Output
Yellow	= Speed control

G.) RELIABILITY

This fan is designed for continuous duty life of 42,000 Hours at 40°C, (L10)

H.) SAFETY

UL, CUL, CE

I.) Flammability

The blower including all components meets an UL94V-0 rating or better.

Notes:

All parameters will perhaps fluctuate with the speed tolerance by \pm 10%.