

# 0RQB-C5U05x Series

## Isolated DC-DC Converter

The 0RQB-C5U05x is an isolated dc/dc converter that operates from a wide input range (18 VDC - 75 VDC) and can cover both 24 VDC and 48 VDC input range. This unit will provide up to 150 W of output power. This unit is designed to be highly efficient and low cost. Features include remote on/off, over current protection, over voltage shut down, over temperature protection and under voltage lockout. This converter is provided in an industry standard 1/4 brick package.



### Key Features & Benefits

- 18 VDC - 75 VDC Input
- 5 VDC / 30 A Output
- Isolated
- Over Temperature Protection
- Ultra-Wide Input Range
- Output Voltage Trim
- Fixed Frequency
- Low Cost
- High Efficiency
- Remote On/Off
- High Power Density
- Input Under-Voltage Lockout
- Input Over-Voltage Lockout
- Over current and short circuit protection
- Basic Isolation
- Positive/Negative Remote Sense
- Output Over-Voltage Shut down
- UL, c-UL Recognized



**bel** POWER  
SOLUTIONS &  
PROTECTION

a bel group

[belfuse.com/power-solutions](http://belfuse.com/power-solutions)

## 1. MODEL SELECTION

OUTPUT VOLTAGE	INPUT VOLTAGE	MAX. OUTPUT CURRENT	MAX. OUTPUT POWER	TYPICAL EFFICIENCY	MODEL NUMBER ACTIVE LOW	MODEL NUMBER ACTIVE HIGH
5 VDC	18 - 75 VDC	30 A	150 W	91%	0RQB-C5U05L	0RQB-C5U050

**NOTE:** 1. Add "G" suffix at the end of the model number to indicate Tray Packaging.  
2. All part numbers above indicate RoHS.

## PART NUMBER EXPLANATION

0	R*	QB	-	C5	U	05	x	G
Mounting Type	RoHS Status	Series Name		Output Power	Input Range	Output Voltage	Active Logic	Package Type
0 - Through hole mount	RoHS	1/4 <sup>th</sup> Brick		150 W	18 – 75 V	5.0 V	0 – Active High L - Active Low	G-Tray package

## 2. ABSOLUTE MAXIMUM RATINGS

PARAMETER	DESCRIPTION	MIN	TYP	MAX	UNITS
Continuous Input Voltage	Non-operating	-0.5	-	80	V
Input Transient Voltage	100 ms maximum	-	-	100	V
Remote On/Off		-0.3	-	18	V
I/O Isolation Voltage		-	-	1500	V
Ambient Temperature		-40	-	85	°C
Storage Temperature		-55	-	125	°C

## 3. INPUT SPECIFICATIONS

PARAMETER	DESCRIPTION	MIN	TYP	MAX	UNIT
Input Voltage	Operating	18	24/48	75	V
Input Current (full load)		-	-	10.5	A
Input Current (no load)		-	100	130	mA
Remote Off Input Current		-	10	15	mA
Input Reflected Ripple Current (pk-pk)	With simulated source impedance of 10 $\mu$ H, 5 Hz to 20 MHz. Use a 100 $\mu$ F / 100 V electrolytic capacitor with ESR = 1 ohm max, at 200 kHz @ 25°C.	-	46	60	mA
Input Reflected Ripple Current (rms)		-	13	18	mA
I <sup>2</sup> t Inrush Current Transient		-	-	0.5	A <sup>2</sup> s
Turn-on Voltage Threshold		-	17.0	17.5	V
Turn-off Voltage Threshold		15.5	16.0	-	V

**CAUTION:** This converter is not internally fused. An input line fuse must be used in application.

Recommend a fast-acting fuse with maximum rating of 15 A on system board. Refer to the fuse manufacture's datasheet for further information.

**NOTE:** 1. This converter has internal C-L-C (0.47  $\mu$ F - 0.47  $\mu$ H - 8.8  $\mu$ F) filter.  
2. All specifications are typical at 25 °C unless otherwise stated.

## 4. OUTPUT SPECIFICATIONS

PARAMETER	DESCRIPTION	MIN	TYP	MAX	UNIT	
Output Voltage Set Point	Vin=48 V, Io=50% load	4.90	5.0	5.10	V	
Line Regulation	Vin=40~56V,Io=100% load	-	±10	±20	mV	
Load Regulation		-	±10	±20	mV	
Regulation Over Temperature	(-40 °C – 85 °C)	-	±30	±50	mV	
Output Current Range		0	-	30	A	
Output Ripple and Noise (pk-pk)	Vin=51V, Io=100% load, Cout=600µF minimum, approximately 50% ceramic, 50% Oscon or POSCAP. Measured at output pins, bandwidth =20MHz	-	70	120	mV	
Output Ripple and Noise (rms)		-	16	25	mV	
Ripple and Noise (pk-pk) under worst case	Over all operating input voltage, load and ambient temperature condition.	-	-	150	mV	
Output DC Current Limit		32	40	48	A	
Short Circuit Surge Transient		-	-	5	A²s	
Turn on Time	Enable form Vin	-	160	200	ms	
	Enable form ON/OFF	-	150	200	ms	
Rise Time		3	-	6	ms	
Overshoot at Turn on		-	0	3	%	
Output Capacitance		0	-	2000	µF	
TRANSIENT RESPONSE						
ΔV 25% ~ 50% of Max Load	Overshoot	di/dt=0.1A/µs, Vin=48VDC, Ta=25°C, with a 1µF ceramic capacitor and a 10µF Tantalum cap at output.	-	120	250	mV
	Settling Time		-	100	200	µs
ΔV 50% ~ 25% of Max Load	Overshoot		-	120	250	mV
	Settling Time		-	100	200	µs

**NOTE:** All specifications are typical at nominal input, full load at 25°C unless otherwise stated.

## 5. GENERAL SPECIFICATIONS

PARAMETER	DESCRIPTION	MIN	TYP	MAX	UNIT
Efficiency	Vin=48 V, full load	90.2	92.5	-	%
	Vin=24 V, full load	90	92	-	
Switching Frequency		-	250	-	kHz
Output voltage trim range		80	-	120	%
FIT	Calculated Per Bell Core SR-332 (Vin=48 V, Vo=5 V, Io=24 A, Ta = 25 °C, FIT=10 <sup>9</sup> /MTBF)		429		
Over Temperature Protection		-	125	-	°C
Over Voltage Protection (Static)	This voltage is achieved by trimming up output slowly	-	7	7.5	V
ISOLATION CHARACTERISTICS					
Isolation Capacitance		-	3900	-	pF
Isolation Resistance		10M	-	-	Ohm
Input to Output		-	-	1500	VDC
Input to case		-	-	1500	VDC
Output to case		-	-	500	VDC
Weight		-	70	-	
Dimensions (L x W xH)		2.30 x 1.45 x 0.50 58.42 x 36.83 x 12.69			inch mm

**NOTE:** All specifications are typical at 25 °C unless otherwise stated.

## 6. EFFICIENCY DATA

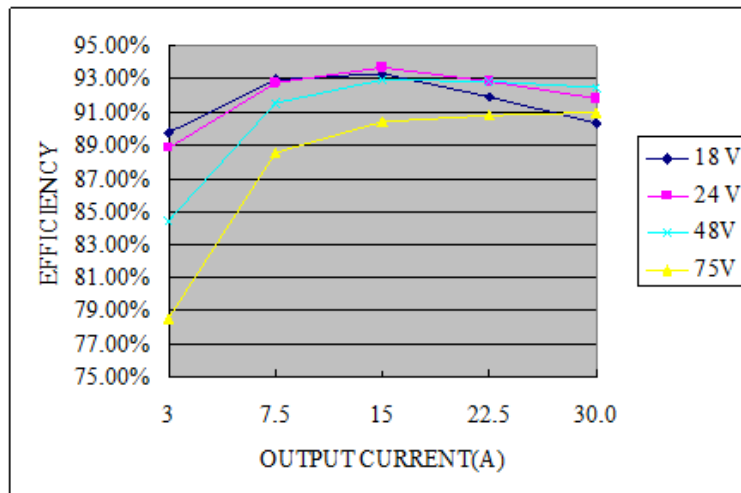

## 7. REMOVE ON/OFF

PARAMETER	DESCRIPTION		MIN	TYP	MAX	UNIT
<b>REMOTE ON/OFF</b>						
Signal Low (Unit On)	Active Low	The remote on/off pin open, Unit off.	-0.3	-	0.8	V
Signal High (Unit Off)			2.4	-	18	
Signal Low (Unit Off)	Active High	The remote on/off pin open, Unit on.	-0.3	-	0.8	V
Signal High (Unit On)			2.4	-	18	
Current Sink			0	-	1	mA

### Recommended remote on/off circuit for active low

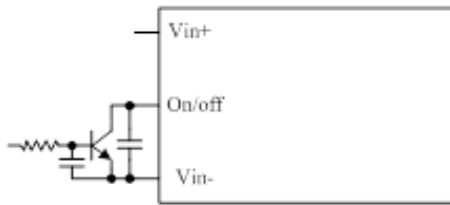

Control with open collector/drain circuit

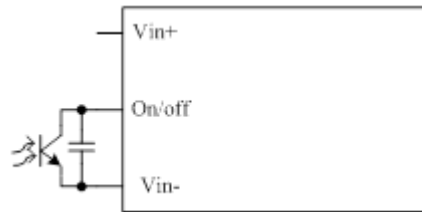

Control with photocoupler circuit

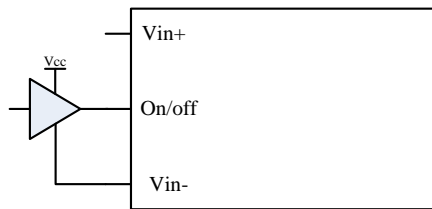

Control with logic circuit

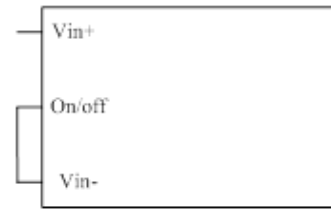

Permanently on

### Recommended remote on/off circuit for active high

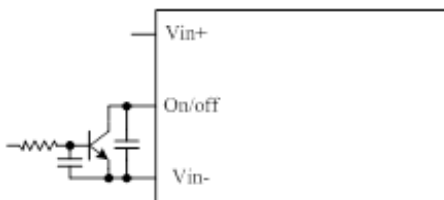

Control with open collector/drain circuit

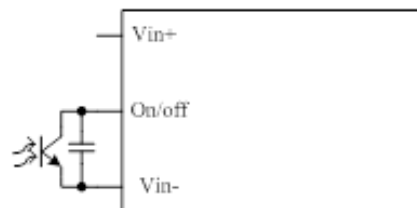

Control with photocoupler circuit

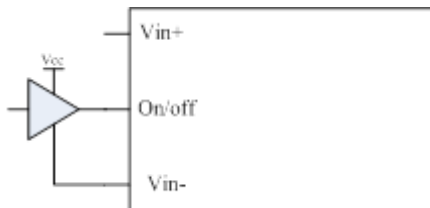

Control with logic circuit

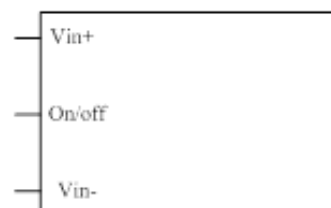

Permanently on

8. INPUT UNDER-VOLTAGE LOCKOUT

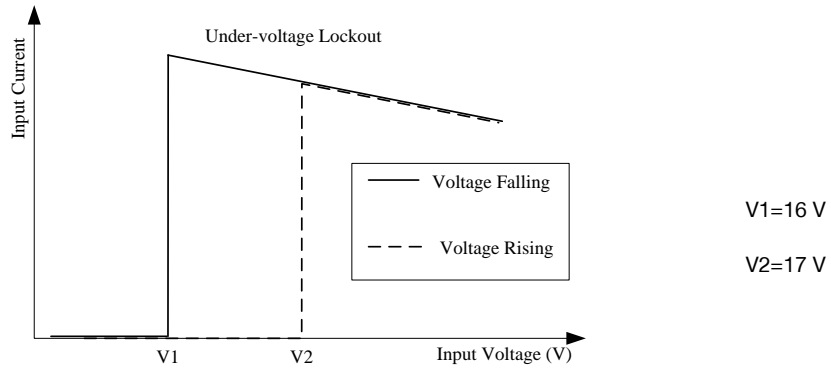

9. RIPPLE AND NOISE WAVEFORM

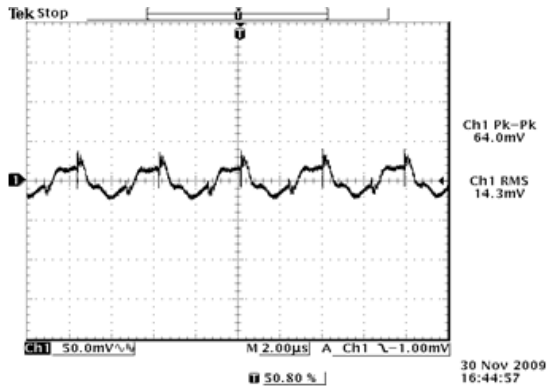

Figure 1. 24VDC input, 5VDC/30A output

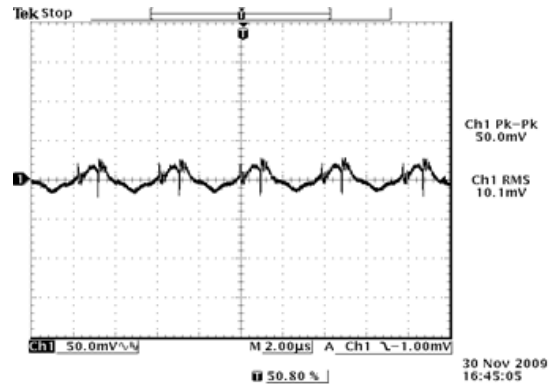

Figure 2. 48VDC input, 5VDC/30A output

**NOTE:** Ripple and noise at full load, with a 1µF ceramic cap and a 10 µF Tantalum cap at output, Ta=25 °C.

## 10. THERMAL DERATING CURVES

Maximum junction temperature of semiconductors derated to 120 °C.

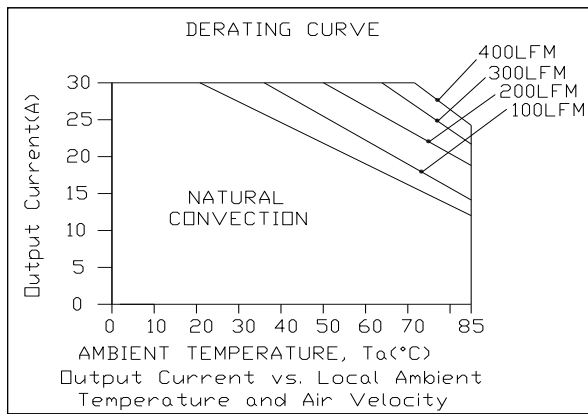

Figure 3.  $V_{in}=24V$   
Derating curve under normal 1 input

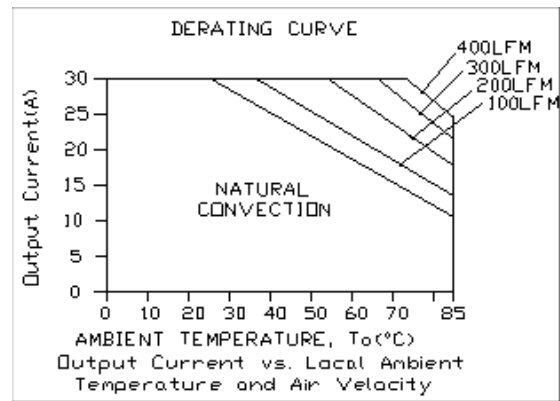
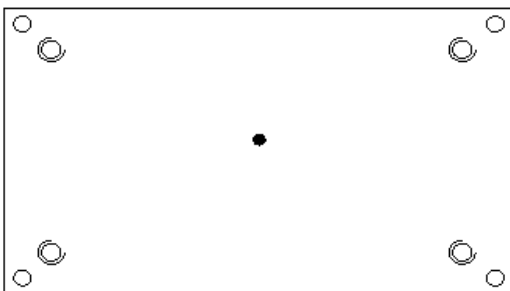
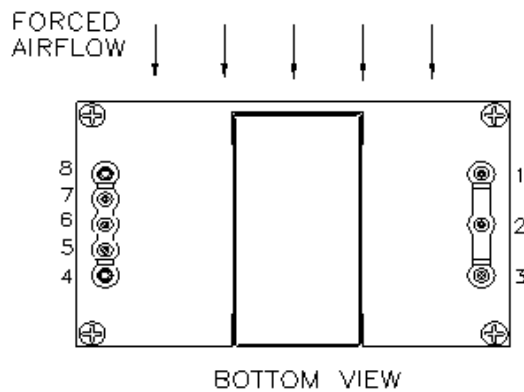
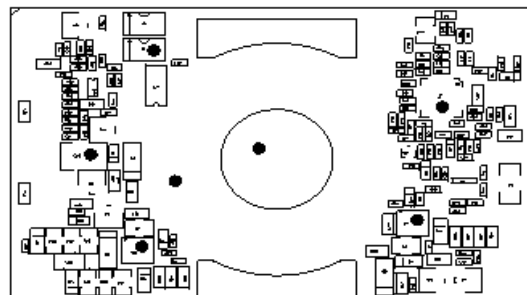

Figure 4.  $V_{in}=48V$   
Derating curve under normal 2 input



Temperature reference points on top side



Temperature reference points on bottom side

11. STARTUP & SHUTDOWN

RISE TIME

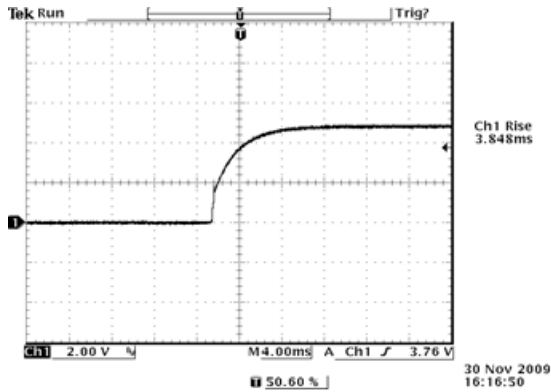

Figure 5.  $V_{in}=24V$ ,  $V_o=5V$ ,  $I_o=30A$

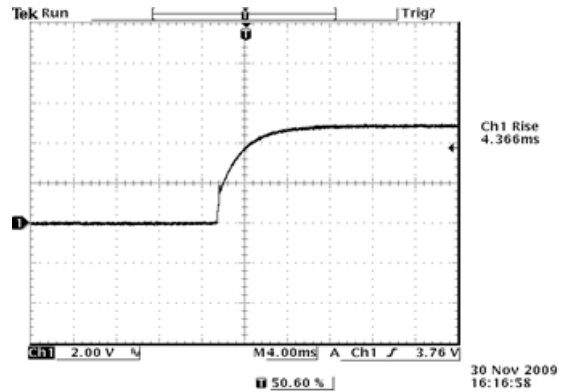

Figure 6.  $V_{in}=48V$ ,  $V_o=5V$ ,  $I_o=30A$

STARTUP TIME

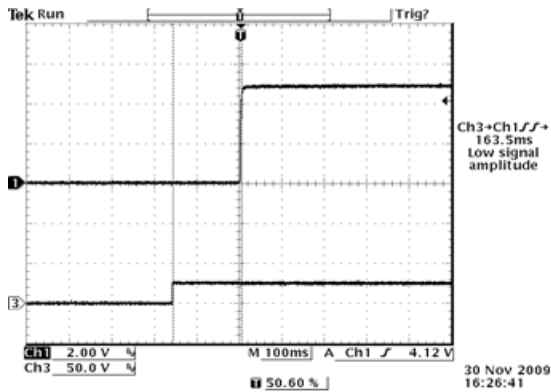

Figure 7. Startup from Vin  
Ch1:  $V_o$   
Ch2:  $V_{in}$   
 $V_{in}=24V$ ,  $V_o=5V$ ,  $I_o=30A$

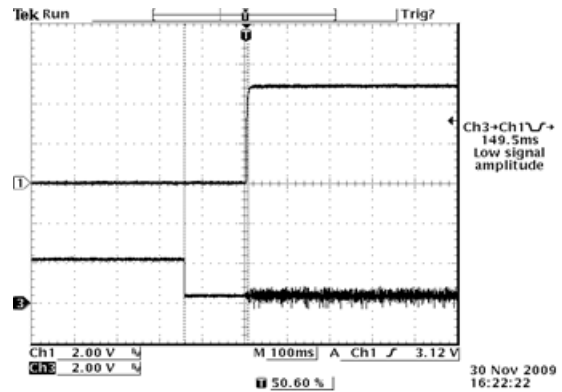

Figure 8. Startup from on/off  
Ch1:  $V_o$   
Ch3: on/off  
 $V_{in}=24V$ ,  $V_o=5V$ ,  $I_o=30A$

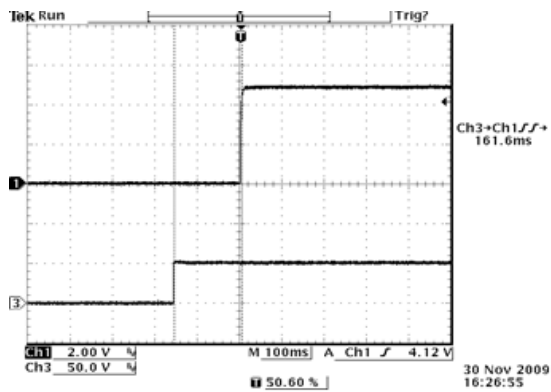

Figure 9. Startup from Vin  
Ch1:  $V_o$   
Ch2:  $V_{in}$   
 $V_{in}=48V$ ,  $V_o=5V$ ,  $I_o=30A$

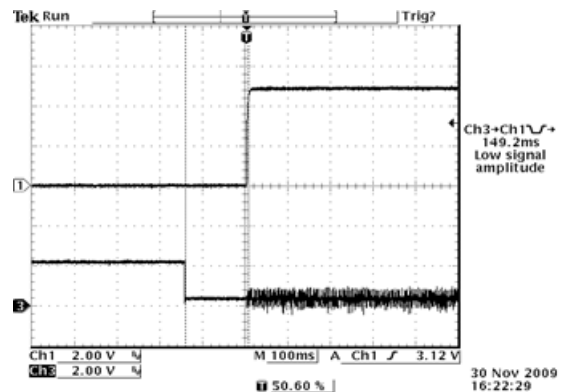

Figure 10. Startup from on/off  
Ch1:  $V_o$   
Ch3: on/off  
 $V_{in}=48V$ ,  $V_o=5V$ ,  $I_o=30A$



## SHUTDOWN

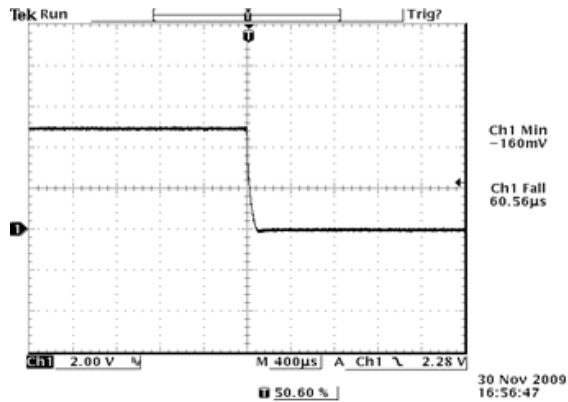

Figure 11.  $V_{in}=24V$ ,  $V_o=5V$ ,  $I_o=30A$

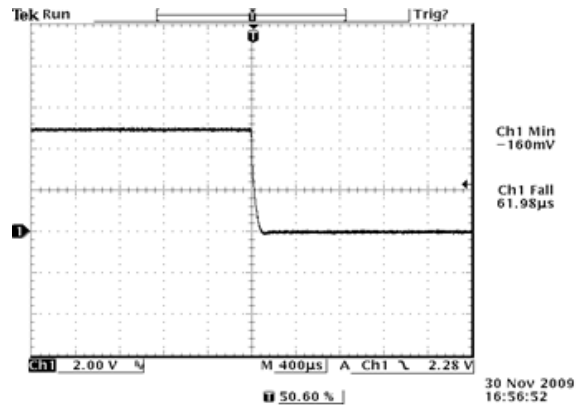

Figure 12.  $V_{in}=48V$ ,  $V_o=5V$ ,  $I_o=30A$

## 12. TRANSIENT RESPONSE WAVEFORMS

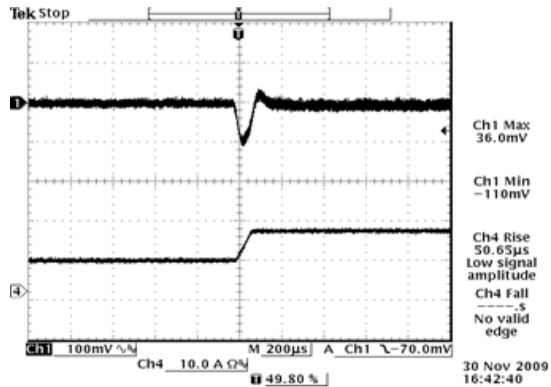

Figure 13. 25%-50% Load Transients at  $V_{in}=24V$ ,  $V_{out}=5V$

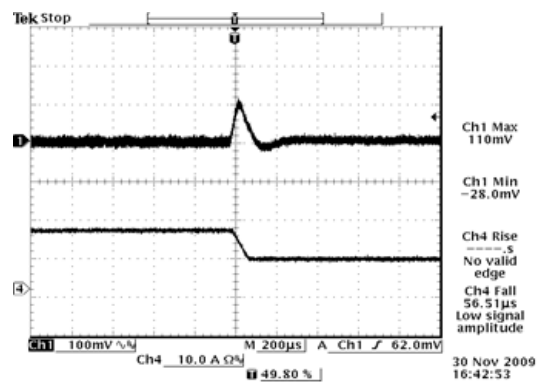

Figure 14. 50%-25% Load Transients at  $V_{in}=24V$ ,  $V_{out}=5V$

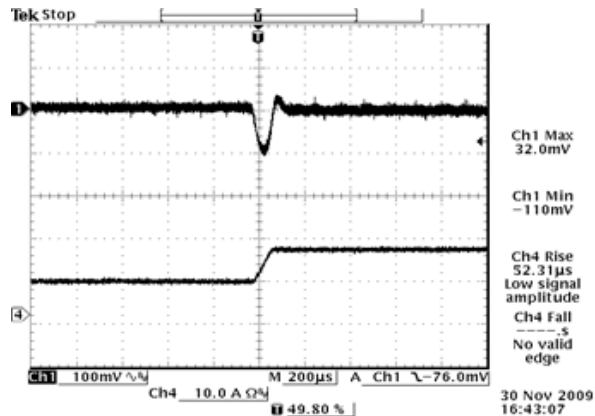

Figure 15. 25%-50% Load Transients at  $V_{in}=48V$ ,  $V_{out}=5V$

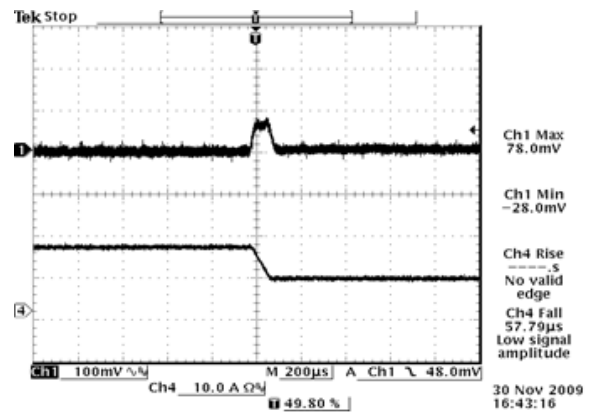
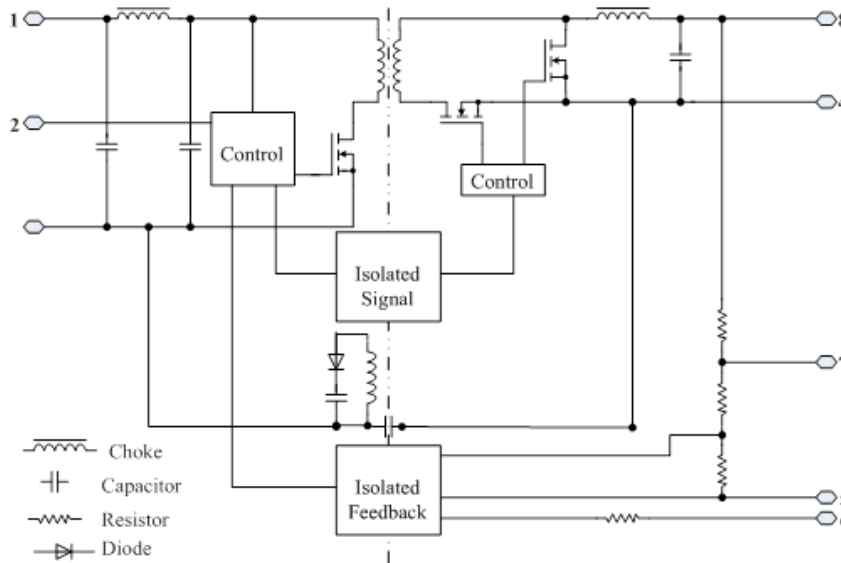

Figure 16. 50%-25% Load Transients at  $V_{in}=48V$ ,  $V_{out}=5V$

**NOTE:** Transient Response at  $di/dt=0.1A/\mu s$ , with a  $1\mu F$  ceramic cap and a  $10\mu F$  aluminum cap at the output,  $T_a=25^\circ C$ .

13. FUNDAMENTAL CIRCUIT DIAGRAM



14. OUTPUT TRIM EQUATIONS

Equations for calculating the trim resistor are shown below. The Trim Down resistor should be connected between the Trim pin and Sense (-) pin. The Trim Up resistor should be connected between the Trim pin and the Sense (+). Only one of the resistors should be used for any given application.

Minimum trim down voltage is 4 V

Maximum trim up voltage is 6 V.

The total voltage increased by trim and remote sense should not exceed 20% of the nominal output voltage.

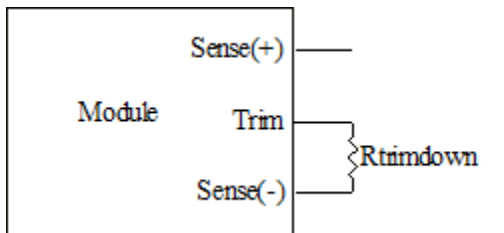

$$R_{trimdown} = \frac{511}{|\Delta|} - 10.22 [k\Omega]$$

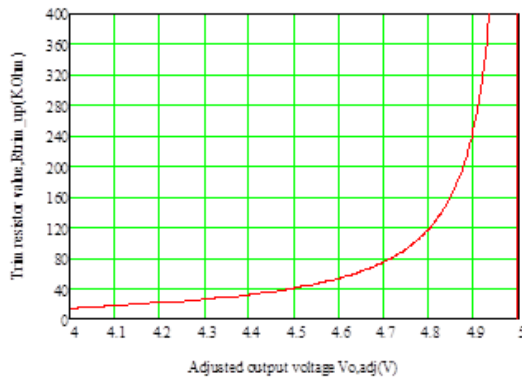

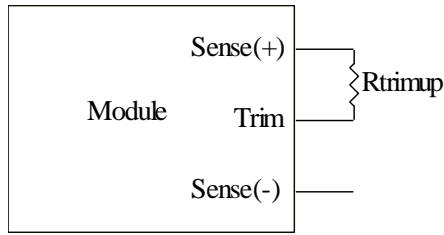

$$R_{trimup} = \frac{(100 + \delta) \cdot V_o \cdot 5.11 - 626}{1.225 \cdot \delta} - 10.22 [k\Omega]$$

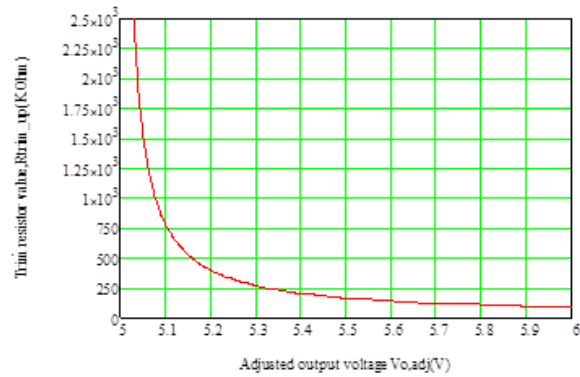

**NOTES:**

Vo\_req=Desired(trimmed) output voltage [V]

Output voltage Vo = 5.000 V

$$\delta = \frac{(V_o_{req} - V_o)}{V_o} \times 100 [\%]$$

## 15. REMOTE SENSE

This module has remote sense compensation feature. It can minimize the effects of resistance between module’s output and load in system layout and facilitates accurate voltage regulation at load terminals or other selected point.

1. The remote sense lines carries very little current and hence do not require a large cross-sectional area.
2. This module compensates for a maximum drop of 10% of the nominal output voltage.
3. If the unit is already trimmed up, the available remote sense compensation range should be correspondingly reduced. The total voltage increased by trim and remote sense should not exceed 10% of the nominal output voltage.
4. When using remote sense compensation, all the resistance, parasitic inductance and capacitance of the system are incorporated within the feedback loop of this module. The can make an effect on the module’s compensation, affecting the stability and dynamic response. A 0.1µF ceramic capacitor can be connected at the point of load to de-couple noise on the sense wires.
5. Recommend the connection of remote sense compensation as below figure. There are a resistor RS+ (100 ohm) from Vo+ to Sense+ and a resistor RS- (51 ohm) from Vo- to Sense- inside of this module.

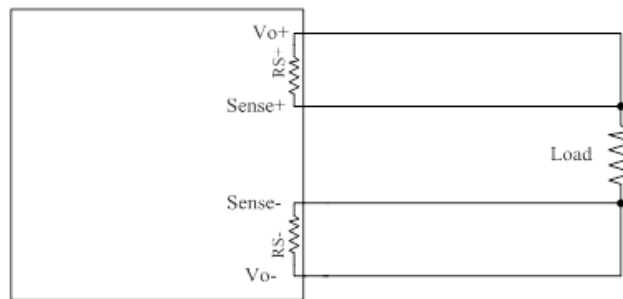

6. If not using remote sense compensation, please connect sense directly to output at module's pin, that is, connect sense+ to Vo+ and sense- to Vo- at module's pin, the shorter the better. see below figure.

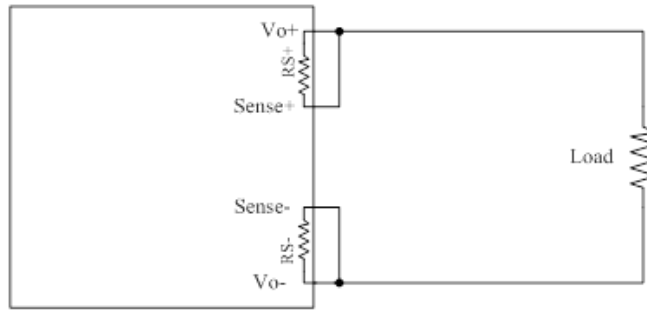

### 16. OVER CURRENT PROTECTION

To provide protection in a fault output overload condition, the module is equipped with internal current-limiting circuitry and can endure current limiting for a few milliseconds. If the over current condition persists beyond a few milliseconds, the module will shut down into hiccup mode and restart once every 560 ms. The module operates normally when the output current goes into specified range. The typical average output current is 5 A during hiccup.

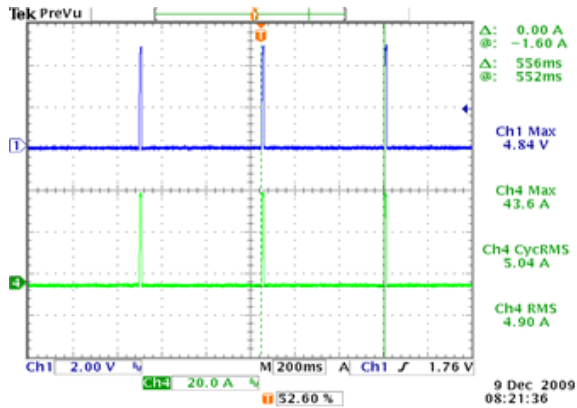

Figure 17.  $V_{in}=48V$ ,  $V_{out}=5V$ ,  $R_{out}=0.09\Omega$

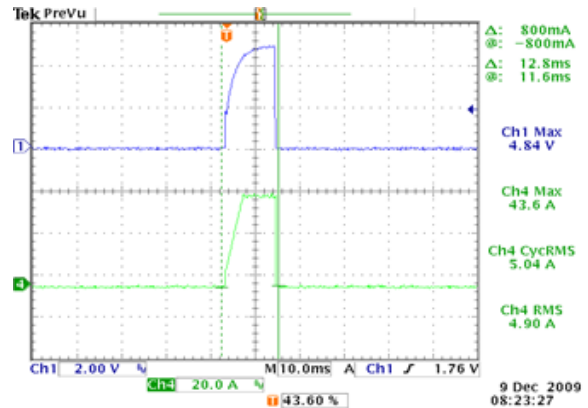
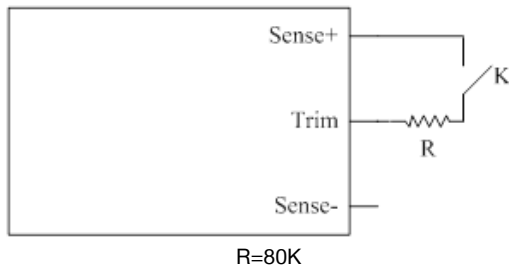

Figure 18. Expansion of on time portion

## 17. OVER VOLTAGE PROTECTION

The output overvoltage protection consists of circuitry that monitors the voltage on the output terminals. If the voltage on the output terminals exceeds the over voltage protection threshold, the module will shutdown into hiccup mode and restart once every 560mS. The module operates normally when the fault is cleared.

### TEST SETUP:



### WAVEFORM:

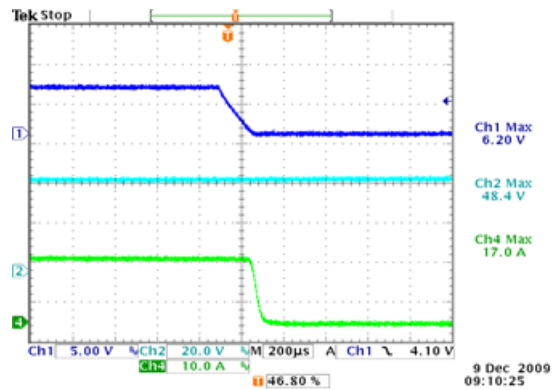

CH1: Output voltage waveform  
CH2: Input voltage waveform  
CH3: Output Current waveform

## 18. OVER TEMPERATURE PROTECTION

The OTP is achieved by thermistor RT and the threshold is set at 120 °C in non-latch mode; the hottest component Q12 reaches 130 °C with 100LFM air flow correspondingly. It will restart automatically when the temperature falls down to 100 °C. The protecting point will be varied a little under different conditions (air flow, ambient temperature, input voltage, load...).

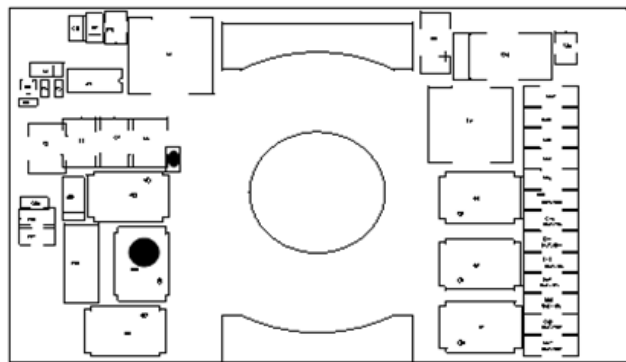

TOP VIEW

19. SAFETY & EMC

**SAFETY:**

- 1. Material flammability UL94V-0
- 2. UL Certification UL60950-1

**EMC:**

- 1. Surge: IEC61000-4-5
- 2. DC-DIP: IEC61000-4-29
- 3. Conductive EMI: EN55022 class A

Compliance to EN55022 class A (both peak and average) with the following inductive and capacitive filter

**SETUP:**

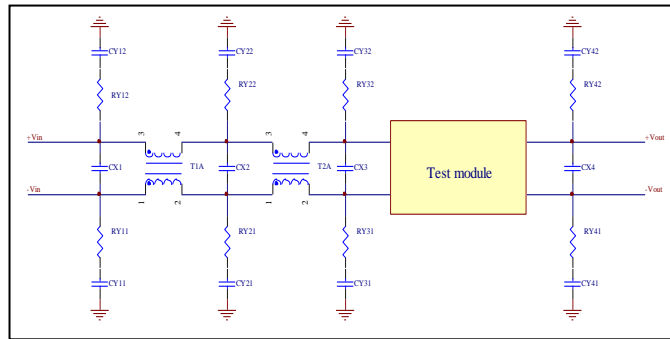

ITEM	DESIGNATOR	PARAMETER	VENDOR	VENDOR P/N
1	CX1,CX2	2.2µF/100V,ceramic	Murata	GRF32ER72A225KA11L
2	CX3	2*100µF/100V,AL cap	Nichicon	UVZ2A101MPD
	RY21,RY22, RY41,RY42	0R	SEI	RMC0805 1/10W 0R 5%
	RY31,RY32	51.1R	SEI	RMC0805 1/10 51R1 1%
3	CY21,CY22	2*6.8nF/2kV, ceramic	Johanson	202S41W682KV4E
4	CY31,CY32, CY41,CY42	2*4.7nF/2kV, ceramic	Johanson	202S41W472KV4E
5	T1	1mH, common mode		PE-53910T
6	T2	2.2mH, common mode	Pulse	

**POSITIVE**

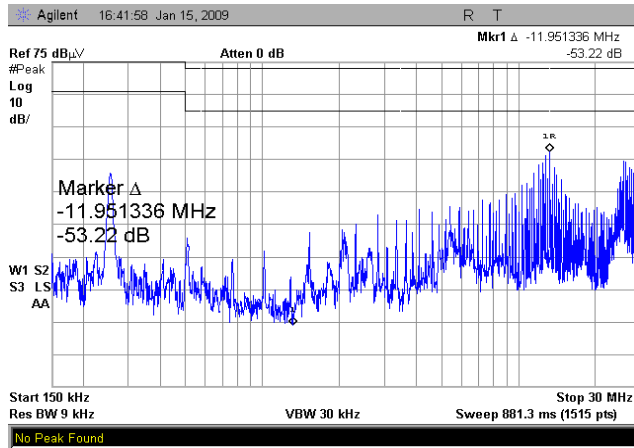

Figure 19. Vin=24V, Vo=5V, Io=30A

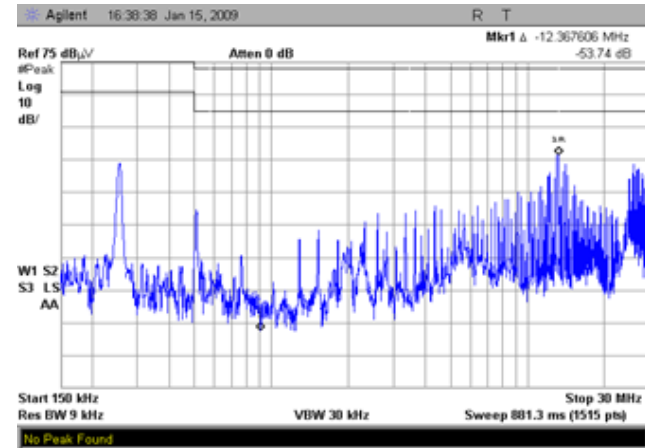

Figure 20. Vin=24V, Vo=5V, Io=30A

## NEGATIVE

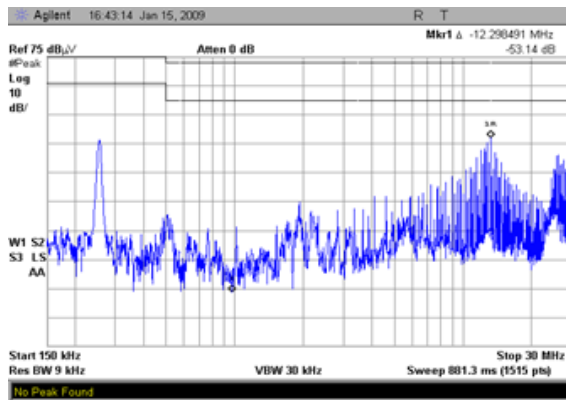

Figure 21.  $V_{in}=24V$ ,  $V_o=5V$ ,  $I_o=30A$

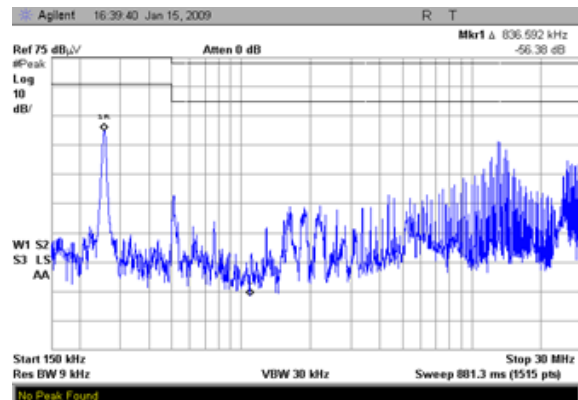

Figure 22.  $V_{in}=24V$ ,  $V_o=5V$ ,  $I_o=30A$

## 20. LAYOUT

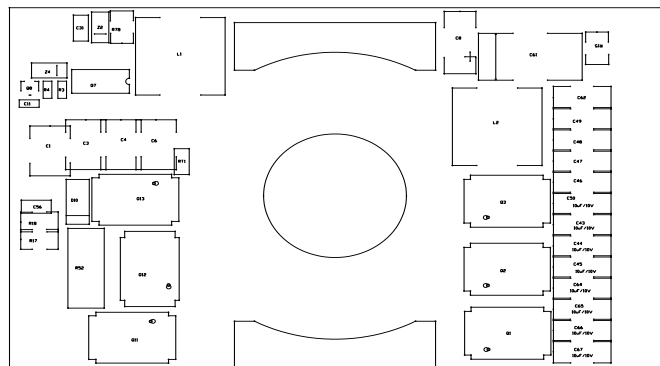

Figure 23. Layout of components on top side

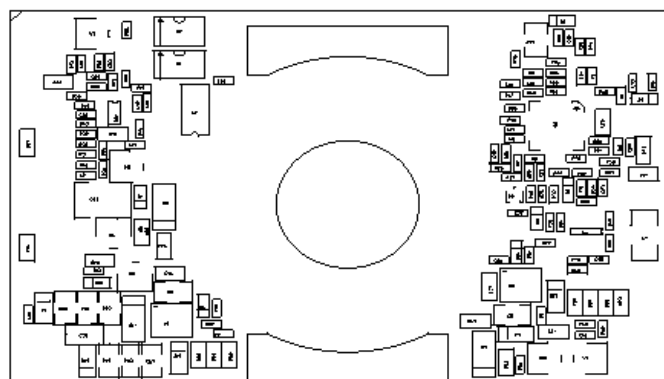
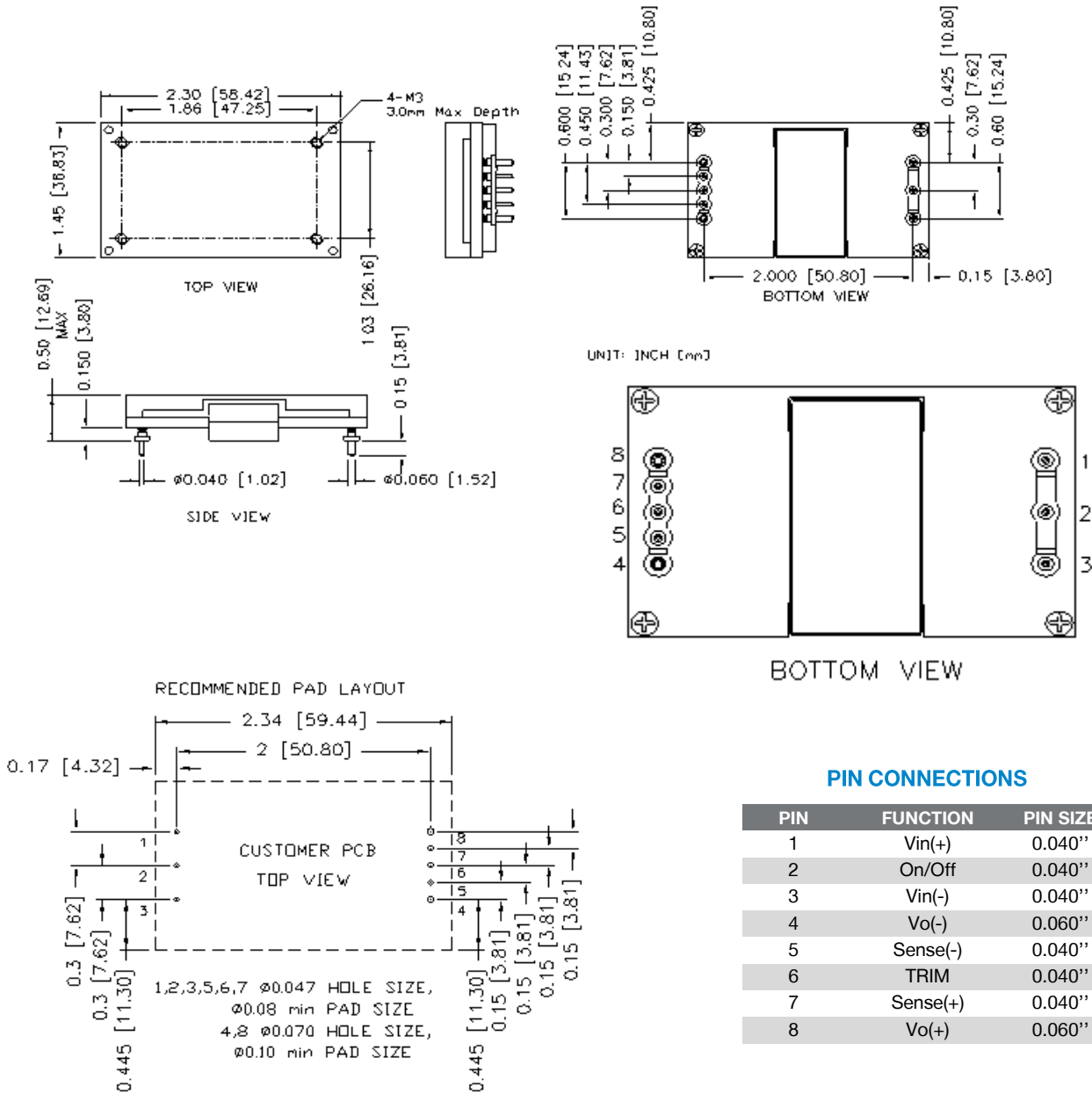

Figure 24. Layout of components on bottom side

21. MECHANICAL OUTLINE



NOTE: This module is recommended and compatible with Pb-Free Wave Soldering and must be soldered using a peak solder temperature of no more than 260 °C for less than 5 seconds.

NOTE:

- 1) All Pins: Material - Copper Alloy;  
Finish - 3 micro inches minimum Gold over 50 micro inches minimum Nickel plate.
- 2) Undimensioned components are shown for visual reference only
- 3) All dimensions in inches (mm); Tolerances: x.xx +/-0.02 in. (x.x +/-0.5mm) x.xxx +/-0.010 in. (x.xx +/-0.25mm).



## 22. REVISION HISTORY

DATE	REVISION	CHANGES DETAIL	APPROVAL
2008-07-24	A	First release	XPCHEN /YJ CAI
2009-02-16	B	Update Cover,Input Specs,Output Specs,General,Efficiency Data,TD,NR,TR,MD	Bin Liu
2009-12-09	C	Update datasheet form; Update mechanical drawing, output DC current limit, transient response, weight and efficiency data; Update thermal derating, noise, transient and trim figure; Add 100V/100ms function, startup and shutdown figure	Bin Liu
2013-10-18	D	Widen trim range	Jessica Yan

**For more information on these products consult: [tech.support@psbel.com](mailto:tech.support@psbel.com)**

**NUCLEAR AND MEDICAL APPLICATIONS** - Products are not designed or intended for use as critical components in life support systems, equipment used in hazardous environments, or nuclear control systems.

**TECHNICAL REVISIONS** - The appearance of products, including safety agency certifications pictured on labels, may change depending on the date manufactured. Specifications are subject to change without notice.



Asia-Pacific  
+86 755 298 85888

Europe, Middle East  
+353 61 225 977

North America  
+1 408 785 5200