

**APT60DQ60BG**  
**Datasheet**  
**Ultra-Fast Soft Recovery Rectifier Diode**

Final  
October 2017



## Contents

---

<b>1</b>	<b>Revision History</b>	<b>1</b>
1.1	Revision C	1
1.2	Revision B	1
1.3	Revision A	1
<b>2</b>	<b>Product Overview</b>	<b>2</b>
2.1	Features	2
2.2	Benefits	2
2.3	Applications	2
<b>3</b>	<b>Electrical Specifications</b>	<b>3</b>
3.1	Absolute Maximum Ratings	3
3.2	Electrical Performance	3
3.3	Dynamic Characteristics	4
3.4	Typical Performance Curves	4
<b>4</b>	<b>Package Specification</b>	<b>8</b>
4.1	Package Outline Drawing	8

# 1 Revision History

---

The revision history describes the changes that were implemented in the document. The changes are listed by revision, starting with the most current publication.

## 1.1 Revision C

Revision C was published in October 2017. The following is a summary of the changes in revision C of this document.

- The product overview was updated. For more information, see [Product Overview \(see page 2\)](#).
- The static characteristics was updated. For more information, see [Table 3 \(see page 3\)](#).
- The package outline drawing was updated. For more information, see [Package Outline Drawing \(see page 8\)](#).

## 1.2 Revision B

Revision B was published in July 2006. The following is a summary of the changes in revision B of this document.

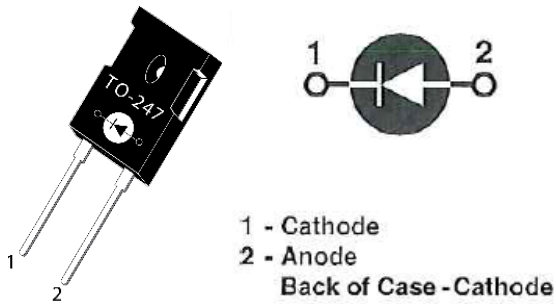
- The product features was updated. For more information, see [Product Overview \(see page 2\)](#).
- The leakage current was updated. For more information, see [Table 3 \(see page 3\)](#).

## 1.3 Revision A

Revision A was published in December 2004. It is the first publication of this document.

## 2 Product Overview

---



### 2.1 Features

The following are key features of the APT60DQ60BG device:

- Ultra-fast recovery times
- Soft recovery characteristics
- Low forward voltage
- Low leakage current
- Avalanche energy rated
- Popular TO-247 package
- RoHS compliant
- AEC-Q101 qualified

### 2.2 Benefits

The following are benefits of the APT60DQ60BG device:

- Higher switching frequency
- Low switching losses
- Low noise (EMI) switching
- Easy to parallel
- Improved system reliability

### 2.3 Applications

The APT60DQ60BG device is designed for the following applications:

- PFC
  - Continuous conduction mode
- Freewheeling diode
  - Inverters
  - Hard- or soft-switched high frequency SMPS
- Clamp diode
  - Single- and two-switch forward
  - Bridge circuits
- Fast output rectifier
  - High output voltage SMPS

### 3 Electrical Specifications

This section details the electrical specifications for the APT60DQ60BG device.

#### 3.1 Absolute Maximum Ratings

The following table shows the absolute maximum ratings for the APT60DQ60BG device.

All Ratings:  $T_c = 25\text{ }^\circ\text{C}$  unless otherwise specified.

**Table 1 • Absolute Maximum Ratings**

Symbol	Parameter	Ratings	Unit
$V_R$	Maximum DC reverse voltage	600	V
$V_{RRM}$	Maximum peak repetitive reverse voltage		
$V_{RWM}$	Maximum working peak reverse voltage		
$I_{F(AV)}$	Maximum average forward current ( $T_c = 110\text{ }^\circ\text{C}$ , duty cycle = 0.5)	60	A
$I_{F(RMS)}$	RMS forward current (square wave, 50% duty)	94	
$I_{FSM}$	Non-repetitive forward surge current ( $T_j = 45\text{ }^\circ\text{C}$ , 8.3 ms)	600	
$E_{AVL}$	Avalanche energy (1 A, 40 mH)	20	mJ
$T_j, T_{STG}$	Operating and storage temperature range	-55 to 175	$^\circ\text{C}$
$T_L$	Lead temperature for 10 seconds	300	

The following table shows the thermal and mechanical characteristics of the APT60DQ60BG device.

**Table 2 • Thermal and Mechanical Characteristics**

Symbol	Characteristic	Min	Typ	Max	Unit
$R_{\theta JC}$	Junction-to-case thermal resistance			0.44	$^\circ\text{C}/\text{W}$
$W_T$	Package weight		0.22		oz
			5.9		g
Torque	Maximum mounting torque			10	lb-in
				1.1	N-m

#### 3.2 Electrical Performance

The following table shows the static characteristics of the APT60DQ60BG device.

**Table 3 • Static Characteristics**

Symbol	Characteristic/Test Conditions	Min	Typ	Max	Unit
$V_F$	Forward Voltage	$I_F = 60\text{ A}$	2.0	2.4	V
		$I_F = 120\text{ A}$	2.44		
		$I_F = 60\text{ A}, T_j = 125\text{ }^\circ\text{C}$	1.7		
$I_{RM}$	Maximum reverse leakage current	$V_R = 600\text{ V}$		25	$\mu\text{A}$
		$V_R = 600\text{ V}, T_j = 125\text{ }^\circ\text{C}$		500	
$C_j$	Junction capacitance, $V_R = 200\text{ V}$		75		pF

### 3.3 Dynamic Characteristics

The following table shows the dynamic characteristics of the APT60DQ60BG device.

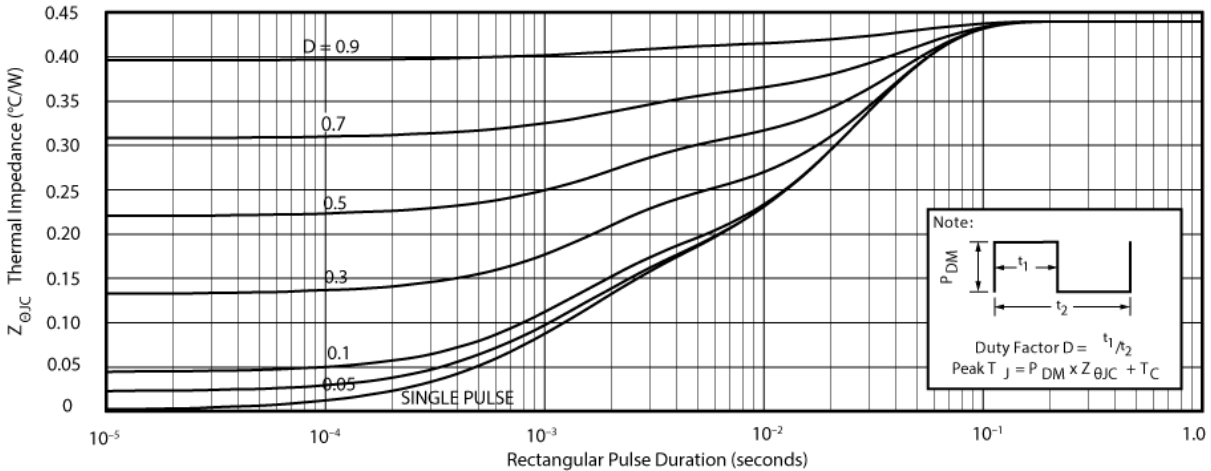
**Table 4 • Dynamic Characteristics**

Symbol	Characteristic	Test Conditions	Min	Typ	Max	Unit
$t_{rr}$	Reverse recovery time	$I_F = 1\text{ A}$ , $di_F/dt = -100\text{ A}/\mu\text{s}$ $V_R = 30\text{ V}$ , $T_J = 25\text{ }^\circ\text{C}$		26		ns
$t_{rr}$	Reverse recovery time	$I_F = 60\text{ A}$ , $di_F/dt = -200\text{ A}/\mu\text{s}$ $V_R = 400\text{ V}$ , $T_C = 25\text{ }^\circ\text{C}$		35		
$Q_{rr}$	Reverse recovery charge			45		nC
$I_{RRM}$	Maximum reverse recovery current			4		A
$t_{rr}$	Reverse recovery time	$I_F = 60\text{ A}$ , $di_F/dt = -200\text{ A}/\mu\text{s}$ $V_R = 400\text{ V}$ , $T_C = 125\text{ }^\circ\text{C}$		175		ns
$Q_{rr}$	Reverse recovery charge			680		nC
$I_{RRM}$	Maximum reverse recovery current			8		A
$t_{rr}$	Reverse recovery time	$I_F = 60\text{ A}$ , $di_F/dt = -1000\text{ A}/\mu\text{s}$ $V_R = 400\text{ V}$ , $T_C = 125\text{ }^\circ\text{C}$		100		ns
$Q_{rr}$	Reverse recovery charge			1380		nC
$I_{RRM}$	Maximum reverse recovery current			26		A

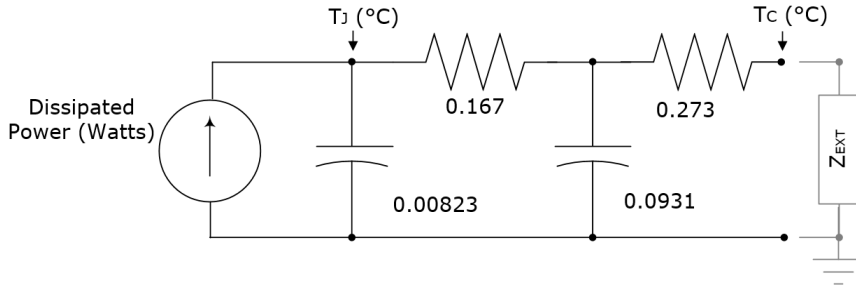
### 3.4 Typical Performance Curves

This section shows the typical performance curves for the APT60DQ60BG device.

**Figure 1 • Maximum Transient Thermal Impedance**

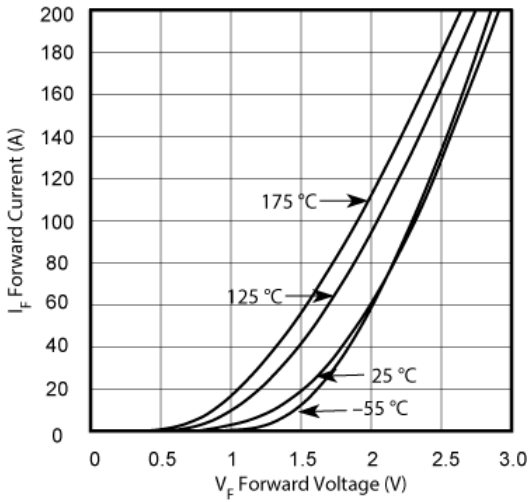


**Figure 2 • Transient Thermal Impedance Model**

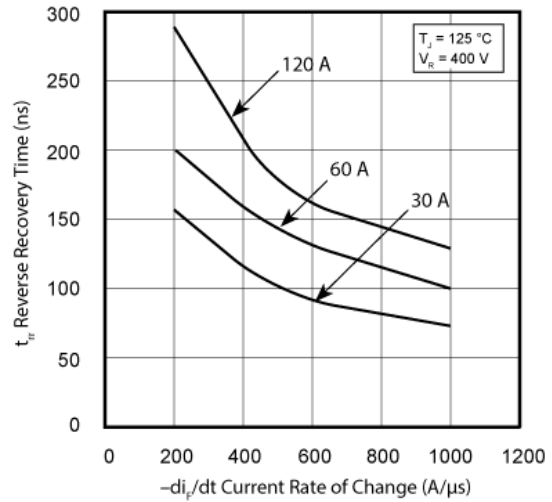


**Note:**  $Z_{EXT}$  are the external thermal impedances (case to sink, sink to ambient, etc.). Set to zero when modeling only the case to junction.

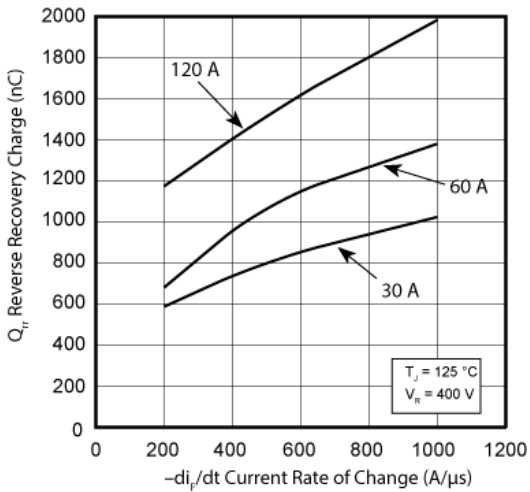
**Figure 3 • Forward Current vs. Forward Voltage**



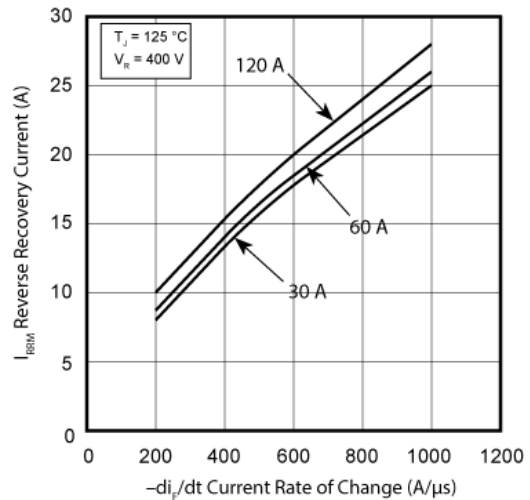
**Figure 4 •  $t_{rr}$  vs. Current Rate of Change**



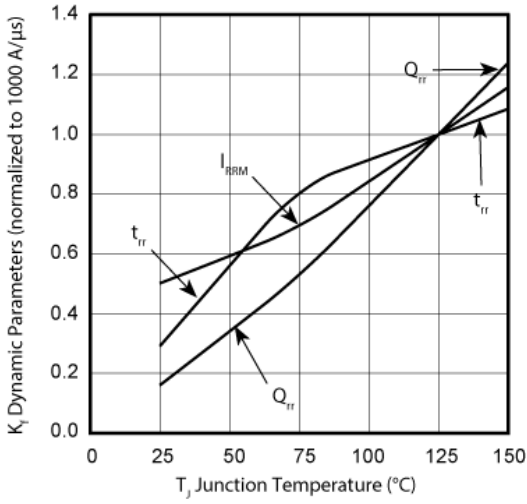
**Figure 5 •  $Q_{rr}$  vs. Current Rate of Change**



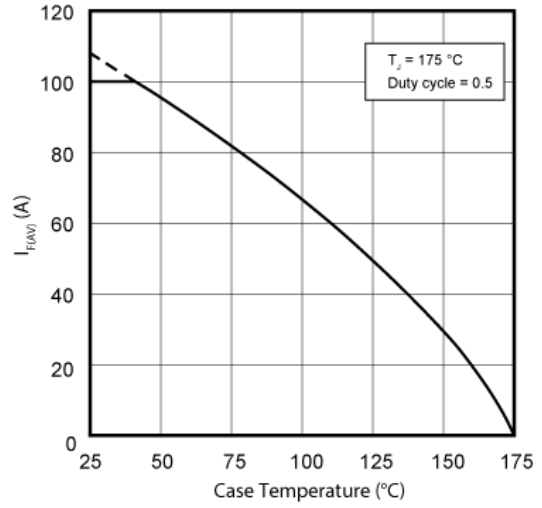
**Figure 6 • IRRM vs. Current Rate of Change**



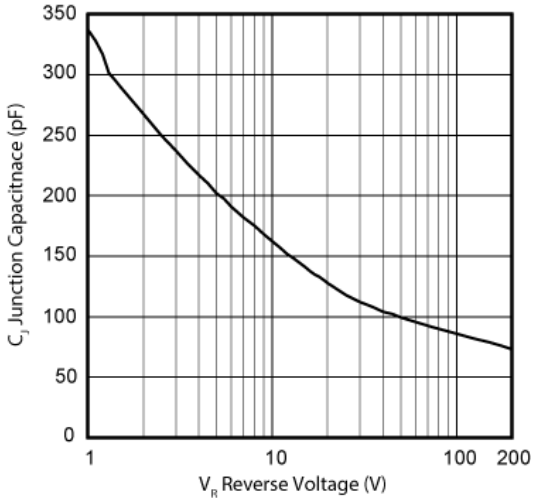
**Figure 7 • Dynamic Parameters vs. Junction Temperature**



**Figure 8 • Maximum Average Forward Current vs. Case Temperature**



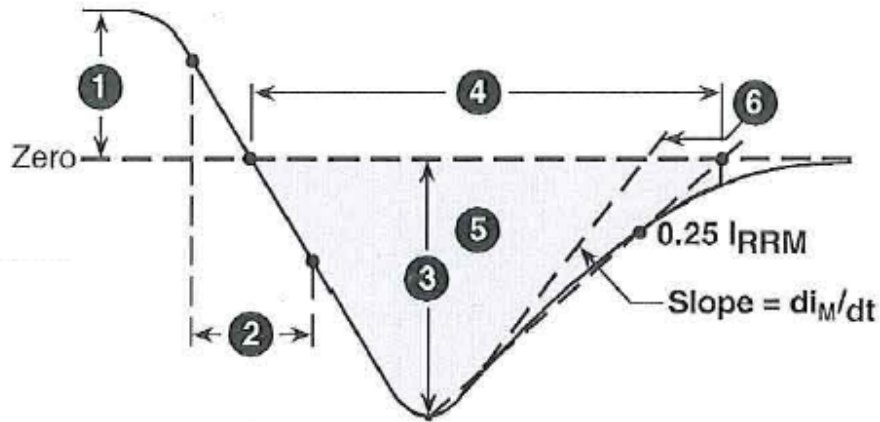
**Figure 9 • Junction Capacitance vs. Reverse Voltage**





The following illustration shows the diode reverse recovery waveform and definitions for the APT60DQ60BG device.

**Figure 10 • Diode Reverse Recovery Waveform and Definitions**



1.  $I_F$ —Forward conduction current.
2.  $di_F/dt$ —Rate of diode current change through zero crossing.
3.  $I_{RRM}$ —Maximum reverse recovery current.
4.  $t_{rr}$ —Reverse recovery time, measured from zero crossing where diode current goes from positive to negative, to the point at which the straight line through  $I_{RRM}$  and  $0.25 \times I_{RRM}$  passes through zero.
5.  $Q_{rr}$ —Area under the curve defined by  $I_{RRM}$  and  $t_{rr}$ .
6.  $di_M/dt$ —Maximum rate of current increase during the trailing portion of  $t_{rr}$ .

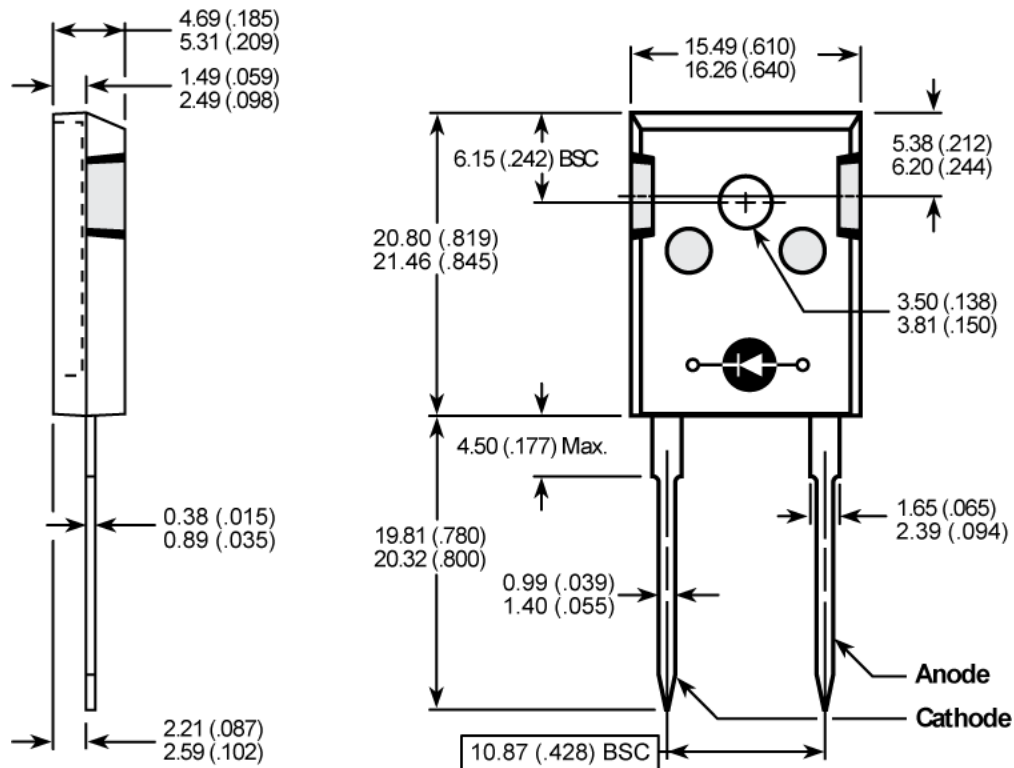
## 4 Package Specification

This section outlines the package specification for the APT60DQ60BG device.

### 4.1 Package Outline Drawing

This section details the TO-247 package drawing of the APT60DQ60BG device. Dimensions are in millimeters and (inches).

**Figure 11 • Package Outline Drawing**



**Microsemi Corporate Headquarters**

One Enterprise, Aliso Viejo,  
 CA 92656 USA  
 Within the USA: +1 (800) 713-4113  
 Outside the USA: +1 (949) 380-6100  
 Fax: +1 (949) 215-4996  
 Email: [sales.support@microsemi.com](mailto:sales.support@microsemi.com)  
[www.microsemi.com](http://www.microsemi.com)

© 2017 Microsemi Corporation. All rights reserved. Microsemi and the Microsemi logo are trademarks of Microsemi Corporation. All other trademarks and service marks are the property of their respective owners.

Microsemi makes no warranty, representation, or guarantee regarding the information contained herein or the suitability of its products and services for any particular purpose, nor does Microsemi assume any liability whatsoever arising out of the application or use of any product or circuit. The products sold hereunder and any other products sold by Microsemi have been subject to limited testing and should not be used in conjunction with mission-critical equipment or applications. Any performance specifications are believed to be reliable but are not verified, and Buyer must conduct and complete all performance and other testing of the products, alone and together with, or installed in, any end-products. Buyer shall not rely on any data and performance specifications or parameters provided by Microsemi. It is the Buyer's responsibility to independently determine suitability of any products and to test and verify the same. The information provided by Microsemi hereunder is provided "as is, where is" and with all faults, and the entire risk associated with such information is entirely with the Buyer. Microsemi does not grant, explicitly or implicitly, to any party any patent rights, licenses, or any other IP rights, whether with regard to such information itself or anything described by such information. Information provided in this document is proprietary to Microsemi, and Microsemi reserves the right to make any changes to the information in this document or to any products and services at any time without notice.

Microsemi Corporation (Nasdaq: MSCC) offers a comprehensive portfolio of semiconductor and system solutions for aerospace & defense, communications, data center and industrial markets. Products include high-performance and radiation-hardened analog mixed-signal integrated circuits, FPGAs, SoCs and ASICs; power management products; timing and synchronization devices and precise time solutions, setting the world's standard for time; voice processing devices; RF solutions; discrete components; enterprise storage and communication solutions; security technologies and scalable anti-tamper products; Ethernet solutions; Power-over-Ethernet ICs and midspans; as well as custom design capabilities and services. Microsemi is headquartered in Aliso Viejo, California, and has approximately 4,800 employees globally. Learn more at [www.microsemi.com](http://www.microsemi.com).

053-4206