

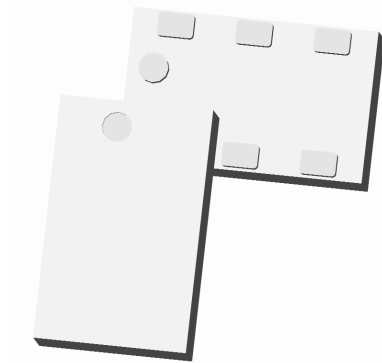

**Ultra Low Profile 0805
3 dB, 90° Hybrid Coupler**

Description:



The C1517J5003AHF is a low cost, low profile sub-miniature high performance 3 dB coupler in an easy to use surface mount package. The C1517J5003AHF is ideal for balanced power and low noise amplifiers, plus signal distribution and other applications where low insertion loss and tight amplitude and phase balance are required. The C1517J5003AHF is available on tape and reel for pick and place high volume manufacturing.

All of the Xinger components are constructed from ceramic filled PTFE composites which possess excellent electrical and mechanical stability. All parts have been subjected to rigorous qualification testing and units are 100% RF tested.

Detailed Electrical Specifications:

Specifications subject to change without notice.

Features:

- 1500 – 1700 MHz
- 0.7mm Height Profile
- High Isolation & Low Loss
- LTE Bands: 24
- Surface Mountable
- Tape & Reel
- Non-conductive Surface
- RoHS Compliant
- Halogen-Free
- 100% RF Tested
- -55°C to 85°C

Parameter	ROOM (25°C)			Unit
	Min.	Typ.	Max	
Frequency	1500		1700	MHz
Port Impedance		50		Ω
Return Loss	21	25		dB
Isolation	24	28		dB
Insertion Loss*		0.2	0.3	dB
Amplitude Balance		0.4	1.0	dB
Phase Balance (relative to 90°)		0.7	4	Degrees
Power Handling			4	Watts
Operating Temperature	-55		+85	°C
Group Delay (1.5-1.7GHz) (nSec)	Min.	Typ.	Max	
	0.093	0.108	0.123	

*Insertion Loss stated at room temperature (Insertion Loss is approximately 0.1 dB higher at +85 °C)

Outline Drawing

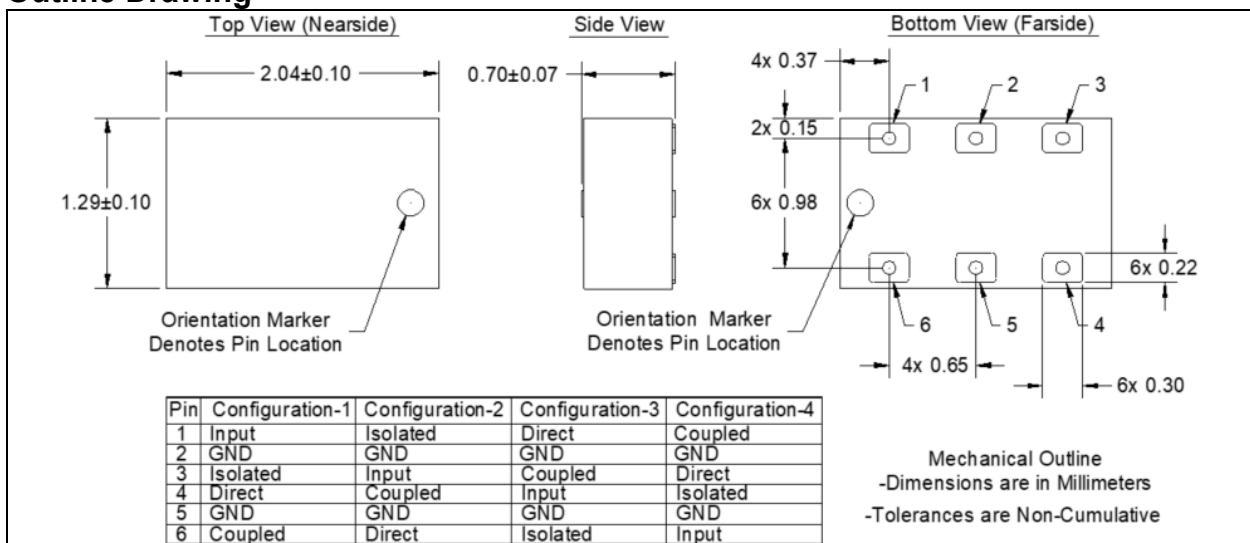

Typical Broadband Performance: 500 MHz. to 6000 MHz.

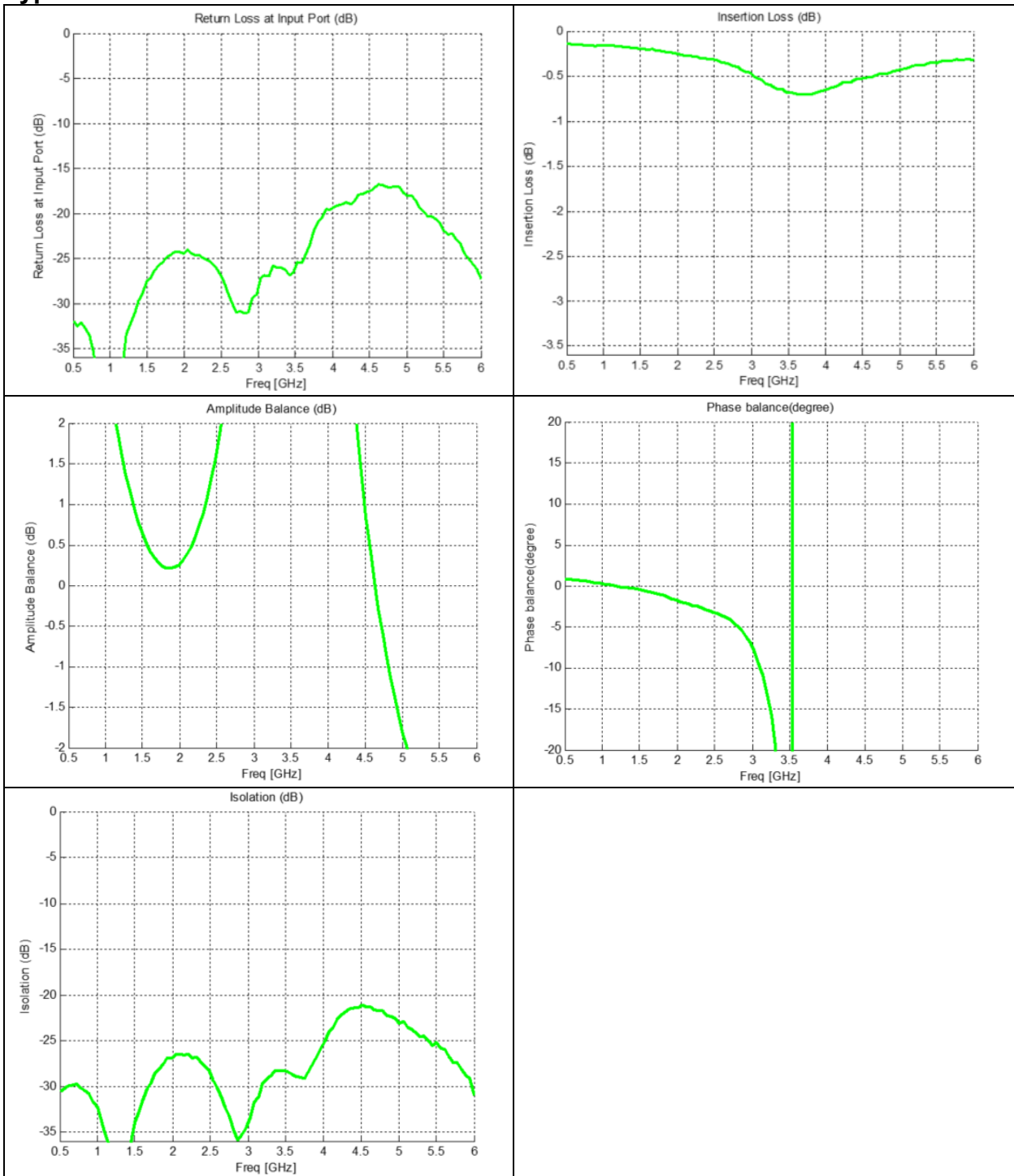

Typical Performance: 1400 MHz. to 1800 MHz.

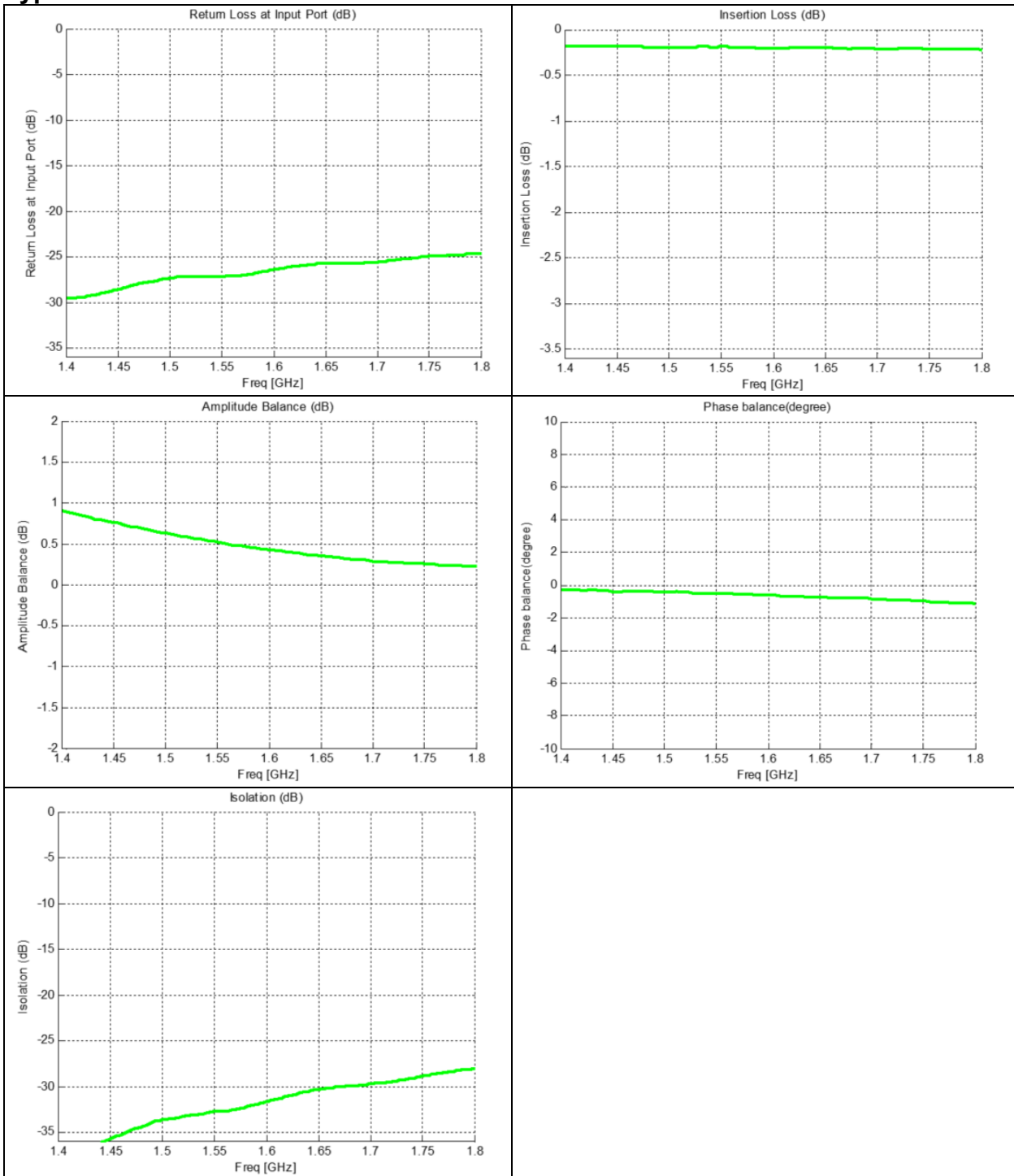

Definition of Measured Specifications

Parameter	Definition	Mathematical Representation
VSWR (Voltage Standing Wave Ratio)	The impedance match of the coupler to a 50Ω system. A VSWR of 1:1 is optimal.	$VSWR = \frac{V_{max}}{V_{min}}$ Vmax = voltage maxima of a standing wave Vmin = voltage minima of a standing wave
Return Loss	The impedance match of the coupler to a 50Ω system. Return Loss is an alternate means to express VSWR.	$Return\ Loss(dB) = 20\log \frac{VSWR + 1}{VSWR - 1}$
Insertion Loss	The input power divided by the sum of the power at the two output ports.	$Insertion\ Loss(dB) = 10\log \frac{P_{in}}{P_{cpl} + P_{direct}}$
Isolation	The input power divided by the power at the isolated port.	$Isolation(dB) = 10\log \frac{P_{in}}{P_{iso}}$
Phase Balance	The difference in phase angle between the two output ports.	Phase at coupled port – Phase at direct port
Group Delay	Group delay is defined as the average of the mean group delay of the coupling path and the mean group delay of the direct path.	$Group\ delay\ (ns) = \frac{Mean(GD(S_{mi})) + Mean(GD(S_{ki}))}{2}$ where "Mean" is the arithmetic mean of the group delay over a frequency band.

*100% RF test is performed per spec definition for pin configuration 1 and port 1 (input port) is connected to pin1, port 2 (isolated port) is connected to pin 3, port 3 (direct port) is connected to pin 4 and port 4 (isolated) is connected to pin 6.

Mounting Configuration:

In order for Xinger surface mount components to work optimally, the proper impedance transmission lines must be used to connect to the RF ports. If this condition is not satisfied, insertion loss, Isolation and VSWR may not meet published specifications.

All of the Xinger components are constructed from organic PTFE based composites which possess excellent electrical and mechanical stability. Xinger components are compliant to a variety of ROHS and Green standards and ready for Pb-free soldering processes. Pads are Gold plated with a Nickel barrier.

An example of the PCB footprint used in the testing of these parts is shown below. In specific designs, the transmission line widths need to be adjusted to the unique dielectric coefficients and thicknesses as well as varying pick and place equipment tolerances.

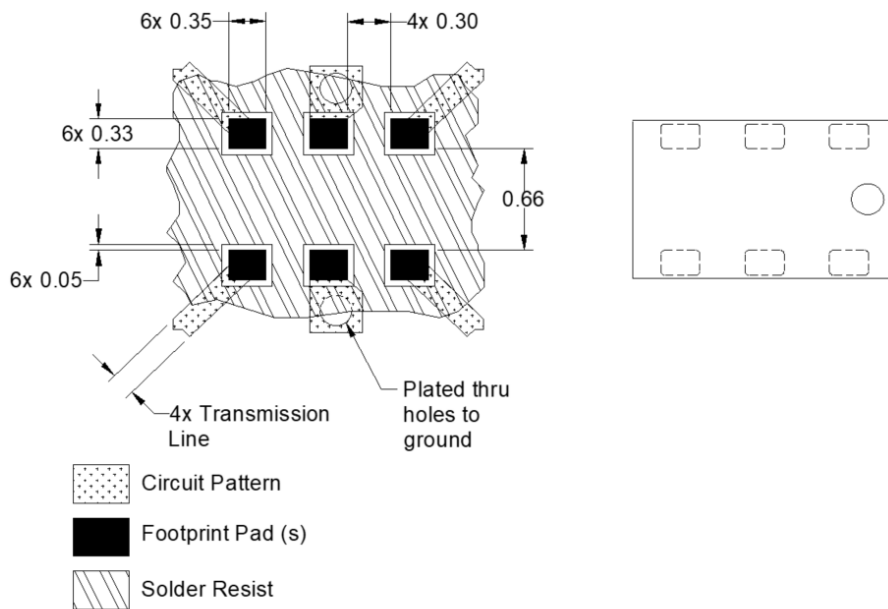

Dimensions are in Millimeters
Mounting Footprint

Packaging and Ordering Information

Parts are available in reel and are packaged per EIA 481-D. Parts are oriented in tape and reel as shown below. Minimum order quantities are 4000 per reel.

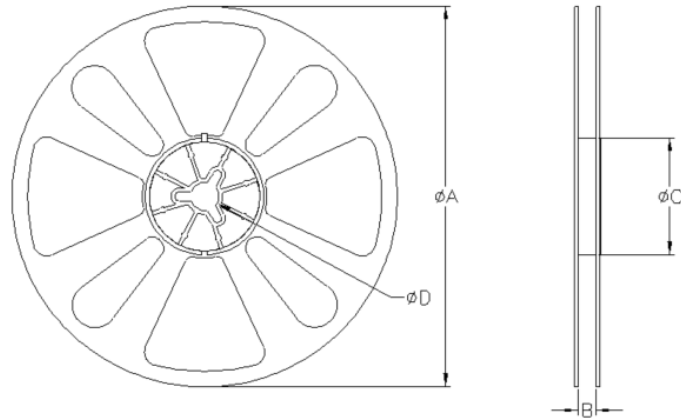
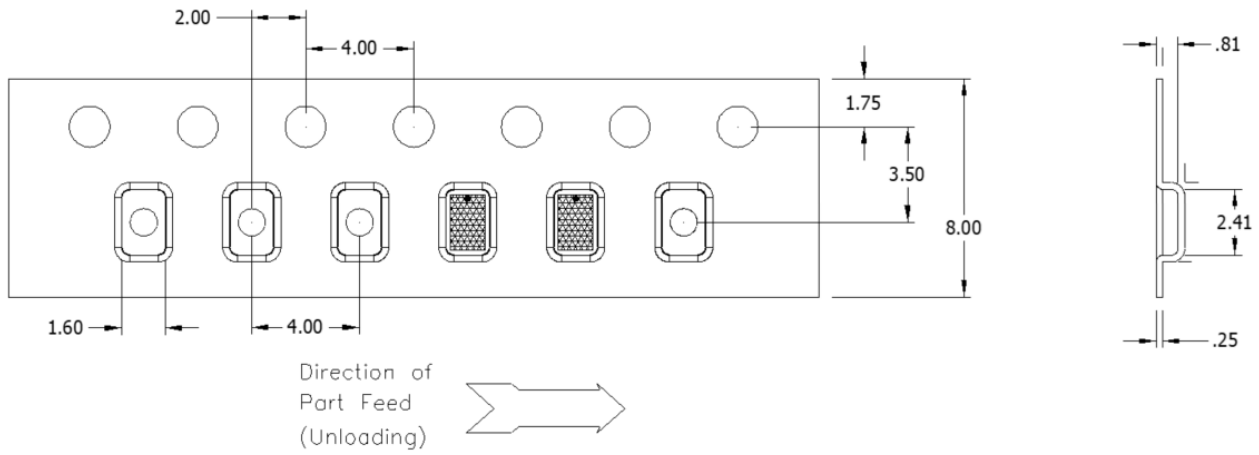

QUANTITY/REEL	REEL DIMENSIONS mm	
4000	ϕA	177.80
	B	8.00
	ϕC	50.80
	ϕD	13.00