



BUL138FP

HIGH VOLTAGE FAST-SWITCHING NPN POWER TRANSISTOR

- STMicroelectronics PREFERRED SALESTYPE
- NPN TRANSISTOR
- HIGH VOLTAGE CAPABILITY
- LOW SPREAD OF DYNAMIC PARAMETERS
- MINIMUM LOT-TO-LOT SPREAD FOR RELIABLE OPERATION
- VERY HIGH SWITCHING SPEED
- FULLY CHARACTERIZED AT 125°C
- FULLY INSULATED PACKAGE (U.L. COMPLIANT) FOR EASY MOUNTING

APPLICATIONS

- ELECTRONIC BALLASTS FOR FLUORESCENT LIGHTING
- FLYBACK AND FORWARD SINGLE TRANSISTOR LOW POWER CONVERTERS

DESCRIPTION

The BUL138FP is manufactured using high voltage Multi Epitaxial Planar technology for high switching speeds and high voltage capability. It uses a Cellular Emitter structure with planar edge termination to enhance switching speeds.

The BUL series is designed for use in lighting applications and low cost switch-mode power supplies.

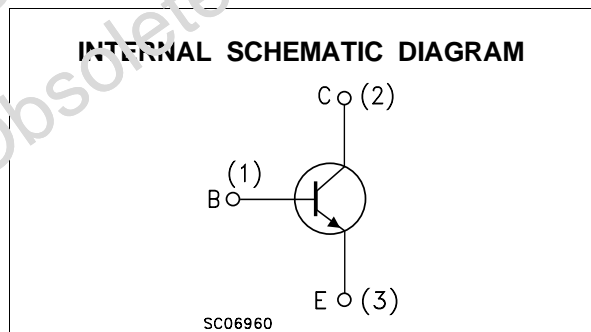
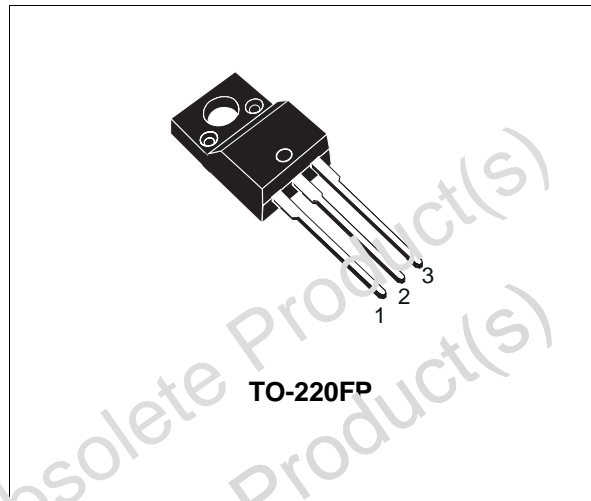

ABSOLUTE MAXIMUM RATINGS

Symbol	Parameter	Value	Unit
V_{CES}	Collector-Emitter Voltage ($V_{BE} = 0$)	800	V
V_{CE0}	Collector-Emitter Voltage ($I_B = 0$)	400	V
V_{EBO}	Emitter-Base Voltage ($I_C = 0$)	9	V
I_C	Collector Current	5	A
I_{CM}	Collector Peak Current ($t_p < 5$ ms)	10	A
I_B	Base Current	2	A
I_{BM}	Base Peak Current ($t_p < 5$ ms)	4	A
P_{tot}	Total Dissipation at $T_c = 25^\circ\text{C}$	33	W
V_{isol}	Insulation Withstand Voltage (RMS) from All Three Leads to External Heatsink	1500	V
T_{stg}	Storage Temperature	-65 to 150	°C
T_j	Max. Operating Junction Temperature	150	°C

BUL138FP

THERMAL DATA

R _{thj-case}	Thermal Resistance Junction-case	Max	3.8	°C/W
R _{thj-amb}	Thermal Resistance Junction-ambient	Max	62.5	°C/W

ELECTRICAL CHARACTERISTICS (T_{case} = 25 °C unless otherwise specified)

Symbol	Parameter	Test Conditions	Min.	Typ.	Max.	Unit
I _{CES}	Collector Cut-off Current (V _{BE} = 0)	V _{CE} = 800 V V _{CE} = 800 V T _j = 125 °C			100 500	μA μA
I _{CEO}	Collector Cut-off Current (I _B = 0)	V _{CE} = 400 V			250	μA
V _{CEO(sus)*}	Collector-Emitter Sustaining Voltage (I _B = 0)	I _C = 100 mA L = 25 mH	400			V
V _{EBO}	Emitter-Base Voltage	I _E = 10 mA	9			V
V _{CE(sat)*}	Collector-Emitter Saturation Voltage	I _C = 1 A I _B = 0.2 A I _C = 2 A I _B = 0.4 A I _C = 3 A I _B = 0.6 A I _C = 4 A I _B = 1 A I _C = 5 A I _B = 1 A		0.7	0.5 0.7 1 1 1	V V V V V
V _{BE(sat)*}	Base-Emitter Saturation Voltage	I _C = 1 A I _B = 0.2 A I _C = 2 A I _B = 0.4 A I _C = 3 A I _B = 0.6 A			1.1 1.3 1.5	V V V
h _{FE*}	DC Current Gain	I _C = 2 A V _{CE} = 5 V I _C = 10 mA V _{CE} = 5 V	8 10		40	
t _s t _f	INDUCTIVE LOAD Storage Time Fall Time	I _C = 2 A I _{B1} = 0.4 A V _{BE(off)} = -5 V R _{BB} = 0 Ω V _{CE} = 250 V L = 200 μH		0.7 50	1.4 100	μs ns
t _s t _f	INDUCTIVE LOAD Storage Time Fall Time	I _C = 2 A I _{B1} = 0.4 A V _{BE(off)} = -5V R _{BB} = 0 Ω V _{CL} = 250 V L = 200 μH T _j = 125 °C		1 75		μs ns

* Pulsed: Pulse duration = 300 μs, duty cycle 1.5 %

Safe Operating Areas

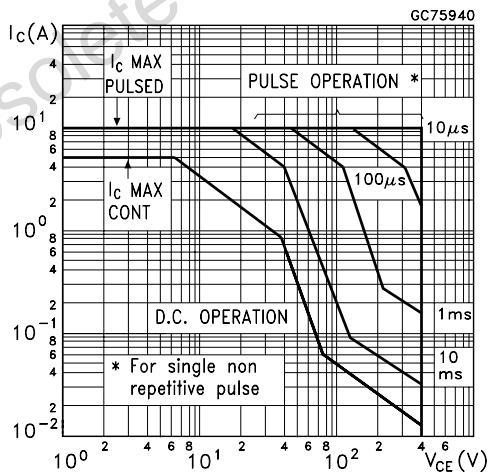

Derating Curve

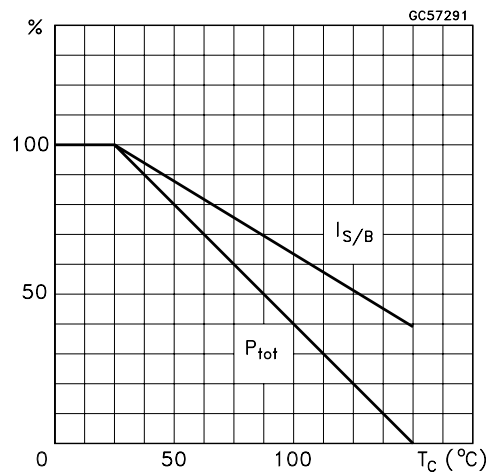

DC Current Gain

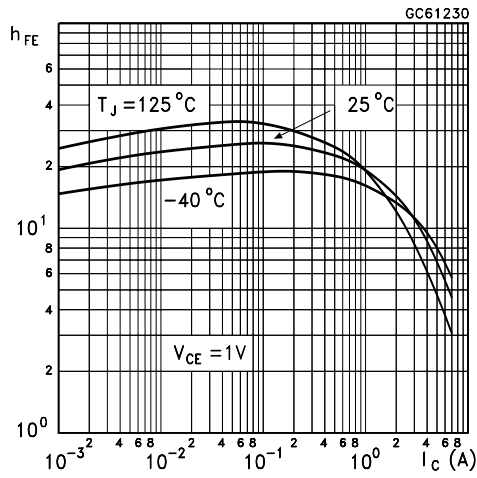

DC Current Gain

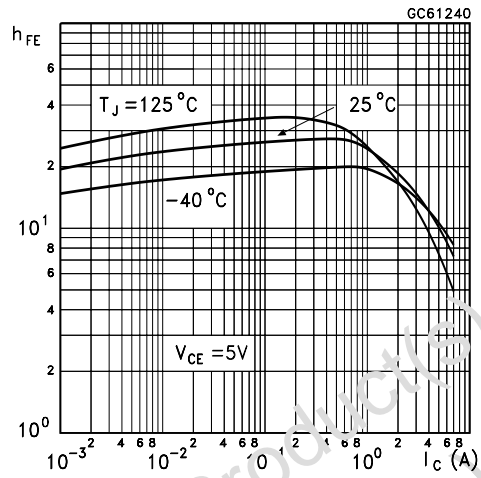

Collector-Emitter Saturation Voltage

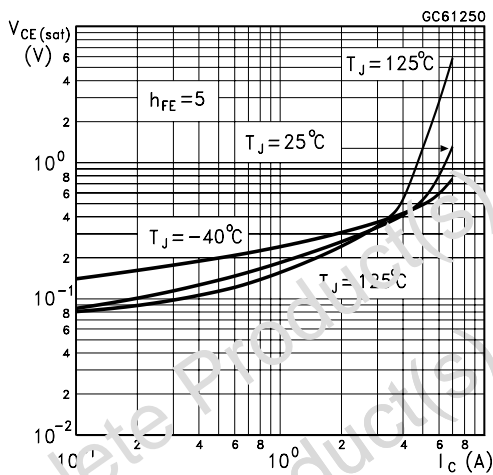

Base-Emitter Saturation Voltage

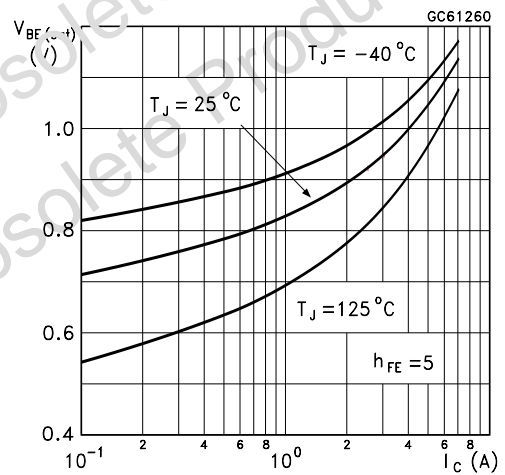

Inductive Fall Time

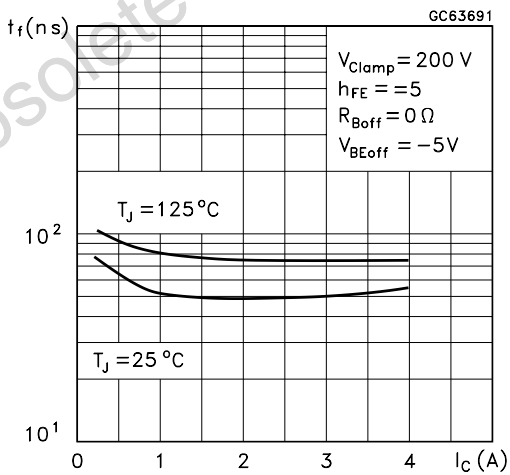

Inductive Storage Time

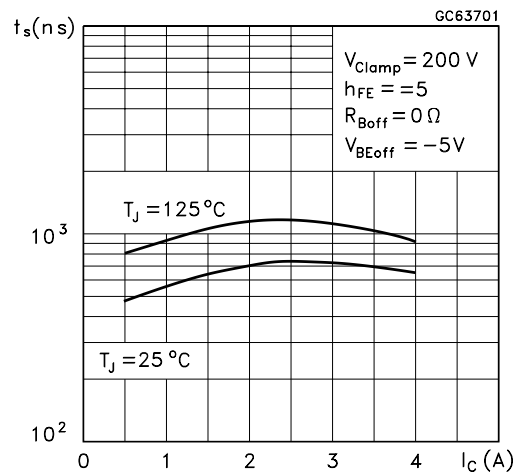

BUL138FP

Reverse Biased SOA

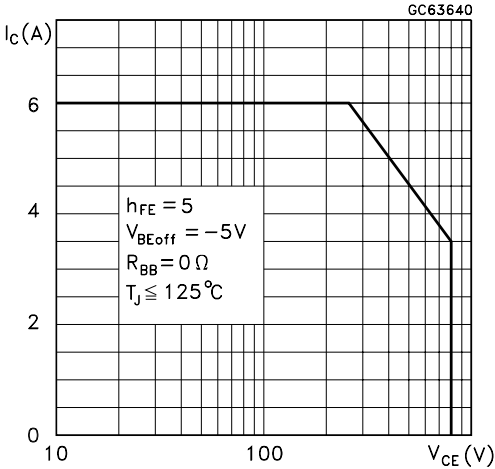

Inductive Load Switching Test Circuit

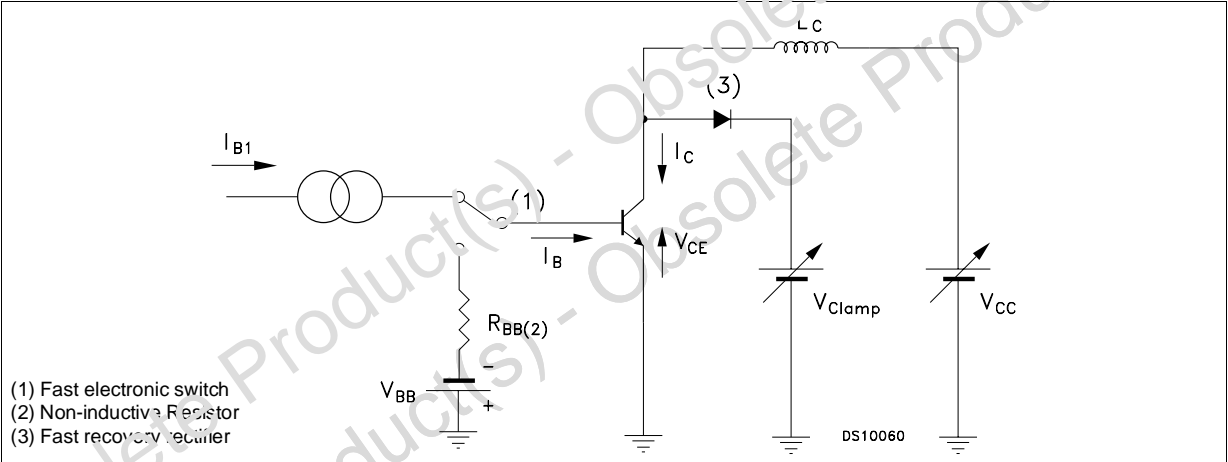

TO-220FP MECHANICAL DATA

DIM.	mm			inch		
	MIN.	TYP.	MAX.	MIN.	TYP.	MAX.
A	4.4		4.6	0.173		0.181
B	2.5		2.7	0.098		0.106
D	2.5		2.75	0.098		0.108
E	0.45		0.7	0.017		0.027
F	0.75		1	0.030		0.039
F1	1.15		1.7	0.045		0.067
F2	1.15		1.7	0.045		0.067
G	4.95		5.2	0.195		0.204
G1	2.4		2.7	0.094		0.106
H	10		10.4	0.393		0.409
L2		16			0.630	
L3	28.6		30.6	1.126		1.204
L4	9.8		10.6	0.385		0.417
L6	15.9		16.4	0.626		0.645
L7	9		9.3	0.354		0.366
Ø	3		3.2	0.118		0.126

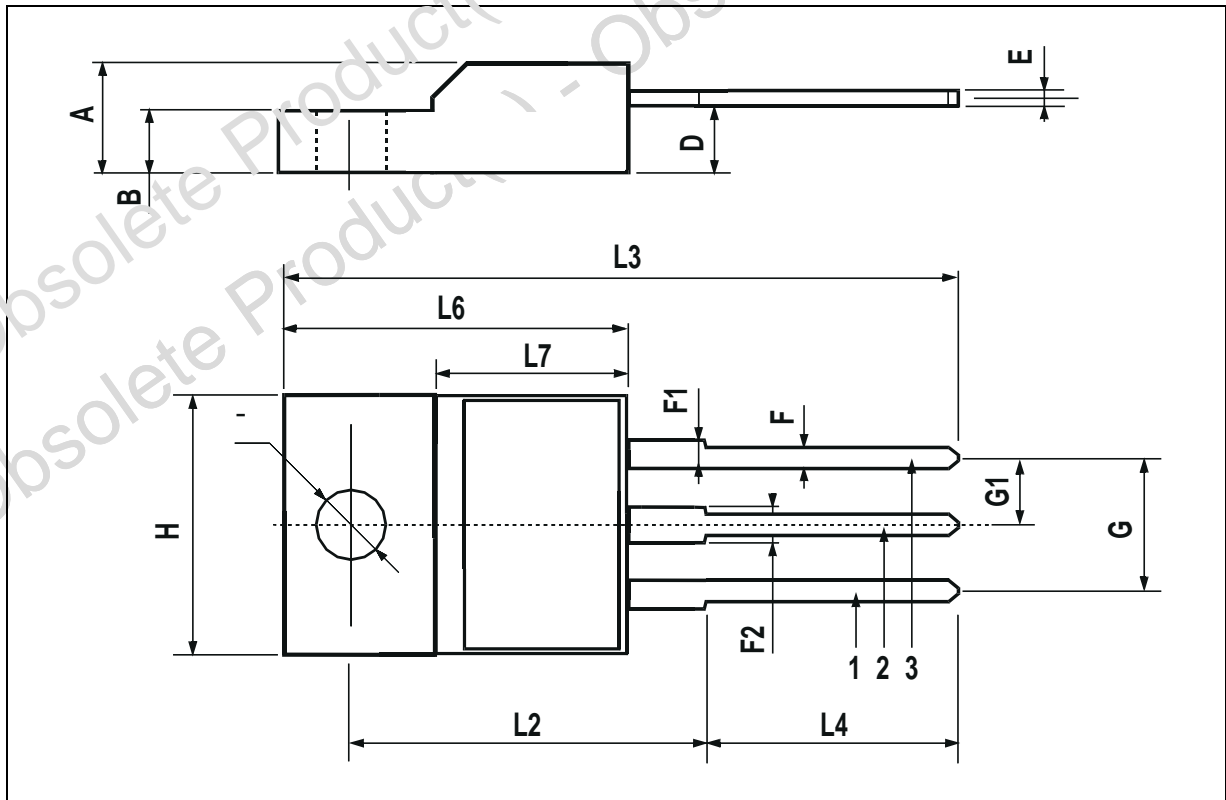

Obsolete Product(s) - Obsolete Product(s)
Obsolete Product(s) - Obsolete Product(s)

Information furnished is believed to be accurate and reliable. However, STMicroelectronics assumes no responsibility for the consequences of use of such information nor for any infringement of patents or other rights of third parties which may result from its use. No license is granted by implication or otherwise under any patent or patent rights of STMicroelectronics. Specification mentioned in this publication are subject to change without notice. This publication supersedes and replaces all information previously supplied. STMicroelectronics products are not authorized for use as critical components in life support devices or systems without express written approval of STMicroelectronics.

The ST logo is a trademark of STMicroelectronics.

All other names are the property of their respective owners.

© 2003 STMicroelectronics – All Rights reserved

STMicroelectronics GROUP OF COMPANIES

Australia - Belgium - Brazil - Canada - China - Czech Republic - Finland - France - Germany - Hong Kong - India - Israel - Italy - Japan - Malaysia - Malta - Morocco - Singapore - Spain - Sweden - Switzerland - United Kingdom - United States.

<http://www.st.com>