

THIS DRAWING IS UNPUBLISHED. RELEASED FOR PUBLICATION 2018
 © COPYRIGHT 2018 BY - ALL RIGHTS RESERVED.

REVISIONS					
P	LTR	DESCRIPTION	DATE	DWN	APVD
	B	LOGO CHANGE; RESIN MARK ADD	08AUG2018	F.Z	R.B

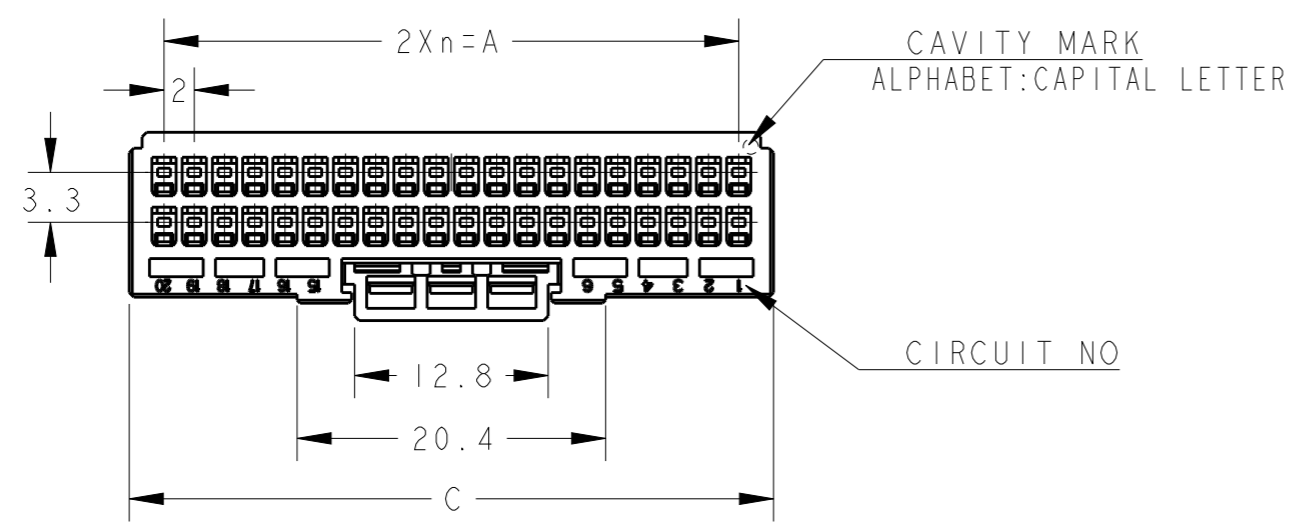

1. MATERIAL: GLASS FILED THERMO PLASTIC POLYESTER(94V-0), COLOR: BLACK
2. THE SHAPE, SIZE AND POSITION OF THE CHARACTER SHOW THE OUTLINE. THEY DON'T SHOW DETAILS.
3. THE KEYING ARRANGEMENT OF "Y" IS SYMMETRIC WITH "X".

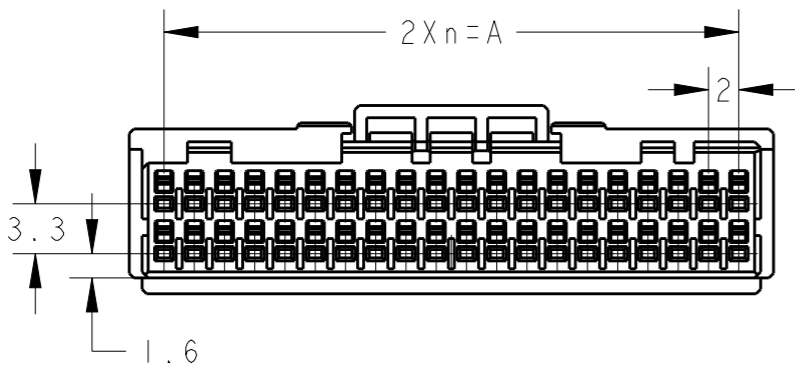
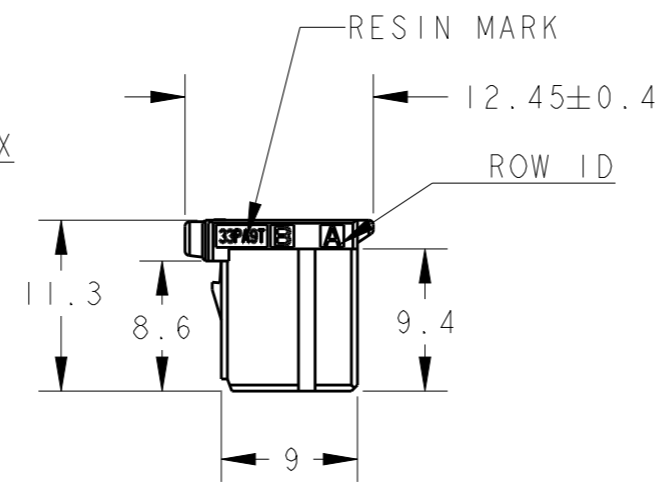
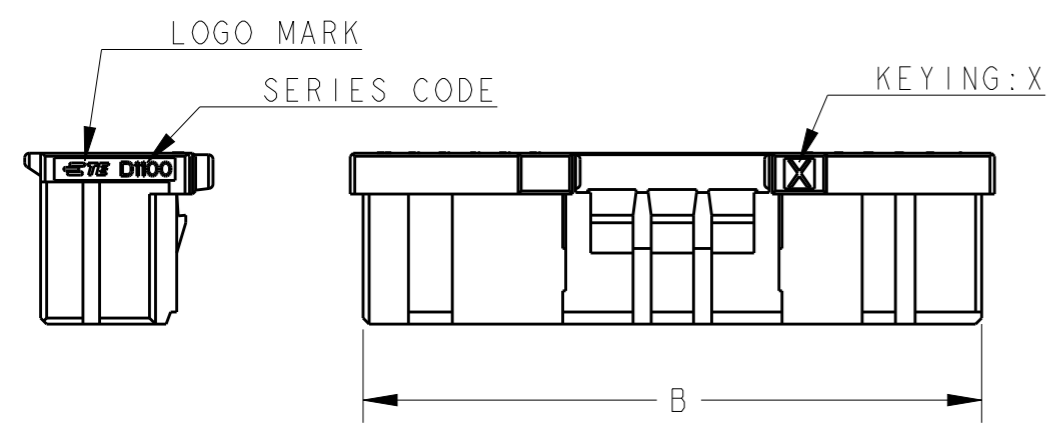

40	Y	19	38.0	40.9	42.6	2-2333134-0
40	X	19	38.0	40.9	42.6	1-2333134-0
34	Y	16	32.0	34.9	36.6	2-2333134-7
34	X	16	32.0	34.9	36.6	1-2333134-7
32	X	15	30.0	32.9	34.6	1-2333134-6
30	X	14	28.0	30.9	32.6	1-2333134-5
28	X	13	26.0	28.9	30.6	1-2333134-4
26	Y	12	24.0	26.9	28.6	2-2333134-3
26	X	12	24.0	26.9	28.6	1-2333134-3
24	X	11	22.0	24.9	26.6	1-2333134-2
22	X	10	20.0	22.9	24.6	1-2333134-1
POS	KEY	n	A	B	C	PART NO

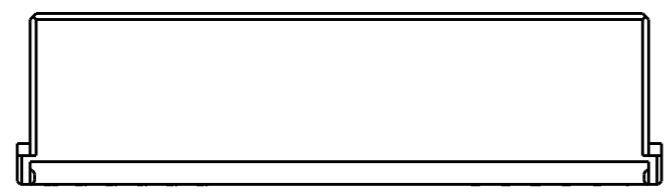

40POS(X-KEY): 1-2333134-0

THIS DRAWING IS A CONTROLLED DOCUMENT.		DWN Fisher ZHU 09-Aug-18	TE Connectivity			
DIMENSIONS: mm		CHK Rick BIAN 09-Aug-18				
TOLERANCES UNLESS OTHERWISE SPECIFIED: ±0.3, ±5°		APVD Rick BIAN 09-Aug-18	NAME DYNAMIC D1100D 2.0mm PITCH			
0 PLC ± 1 PLC ±0.3 2 PLC ±0.10 3 PLC ±0.001 4 PLC ±0.0001 ANGLES ±		PRODUCT SPEC 108-78268, 78298	REC HSG			
MATERIAL		APPLICATION SPEC 114-5377	22-40POS			
FINISH		WEIGHT -	SIZE A3	CAGE CODE 00779	DRAWING NO C-2333134	RESTRICTED TO -
		CUSTOMER DRAWING	SCALE 2:1	SHEET 1 OF 3	REV B	

REVISIONS

P	LTR	DESCRIPTION	DATE	DWN	APVD
		SEE SHEET 1			

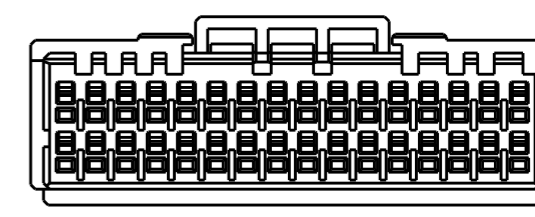
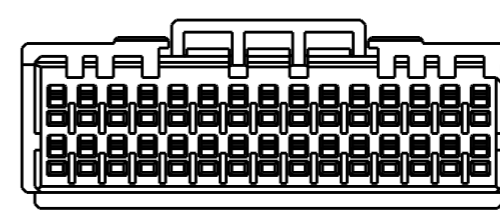
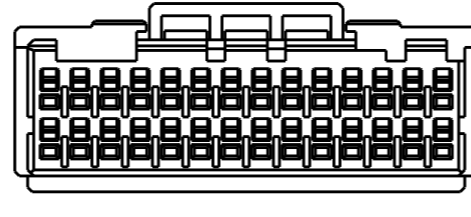
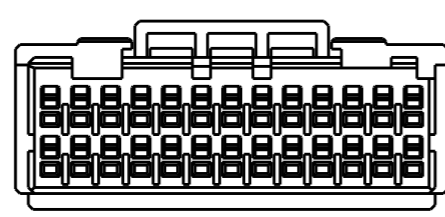
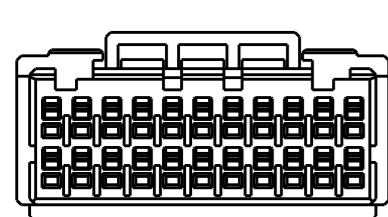
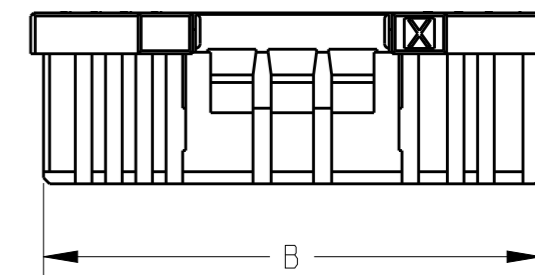
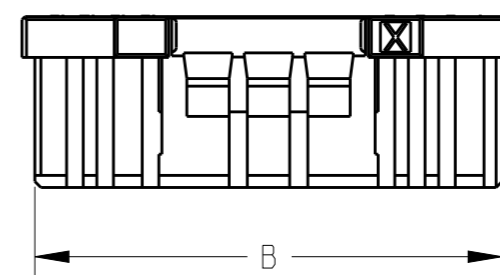
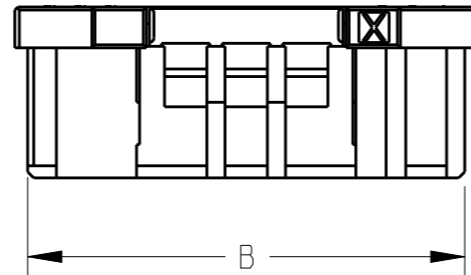
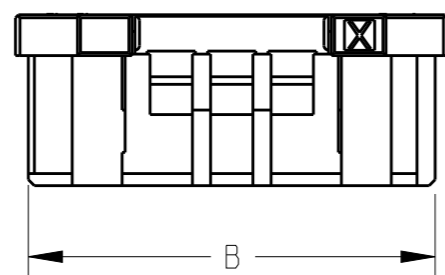
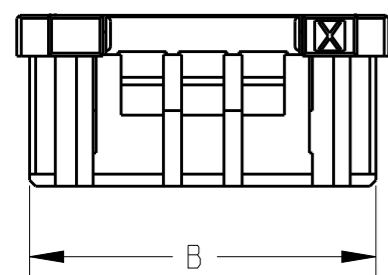
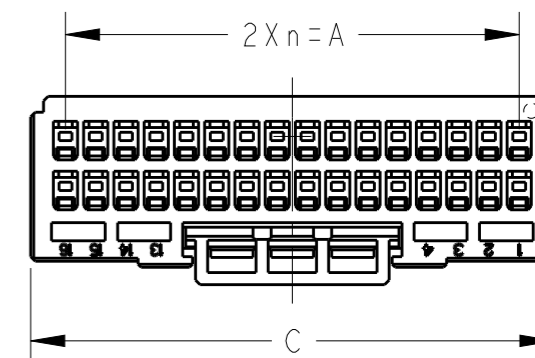
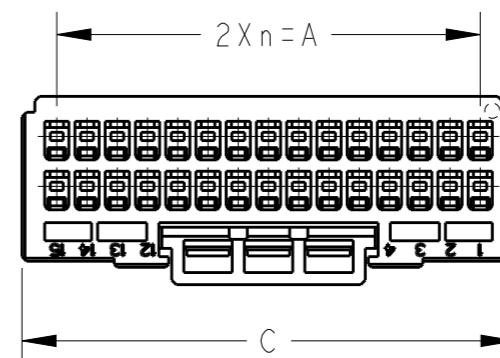
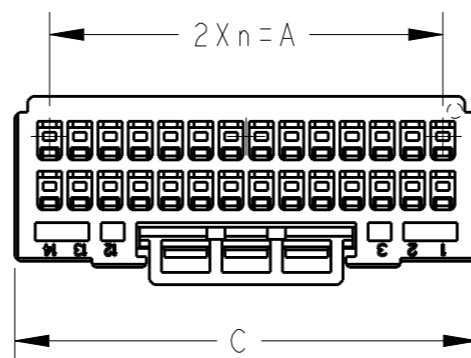
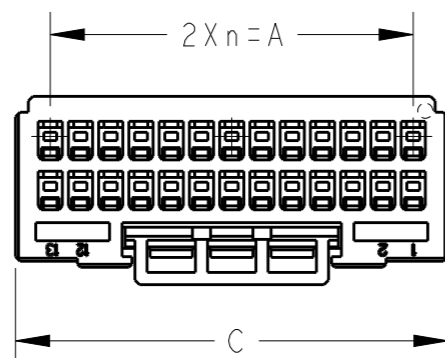
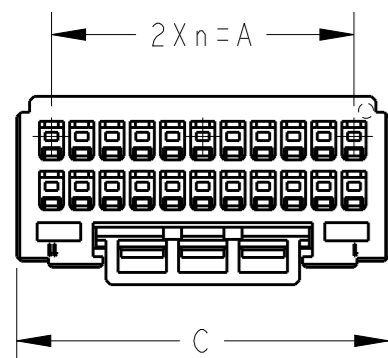

22POS(X-KEY): I-2333134-1

26POS(X-KEY): I-2333134-3

28POS(X-KEY): I-2333134-4

30POS(X-KEY): I-2333134-5

32POS(X-KEY): I-2333134-6

THIS DRAWING IS A CONTROLLED DOCUMENT.

DIMENSIONS: mm



TOLERANCES UNLESS OTHERWISE SPECIFIED:

- 0 PLC ±
- 1 PLC ±
- 2 PLC ±
- 3 PLC ±
- 4 PLC ±
- ANGLES ±
- FINISH -

MATERIAL -

DWN 09-Aug-18
Fisher ZHU
CHK 09-Aug-18
Rick BIAN
APVD 09-Aug-18
Rick BIAN
PRODUCT SPEC
108-78268,78298
APPLICATION SPEC
114-5377
WEIGHT -



NAME
DYNAMIC D1100D 2.0mm PITCH
REC HSG
22-40POS

SIZE	CAGE CODE	DRAWING NO	RESTRICTED TO
A3	00779	C-2333134	-

CUSTOMER DRAWING SCALE 2:1 SHEET 2 OF 3 REV B

SEE SHEET 1 OF 3

THIS DRAWING IS UNPUBLISHED.

RELEASED FOR PUBLICATION

2018

© COPYRIGHT 2018 BY -

ALL RIGHTS RESERVED.

REVISIONS

P	LTR	DESCRIPTION	DATE	DWN	APVD
		SEE SHEET 1			

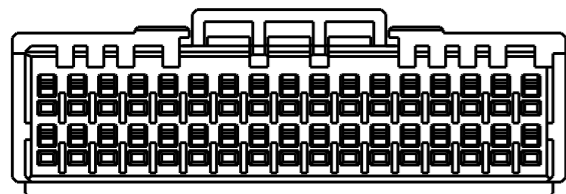
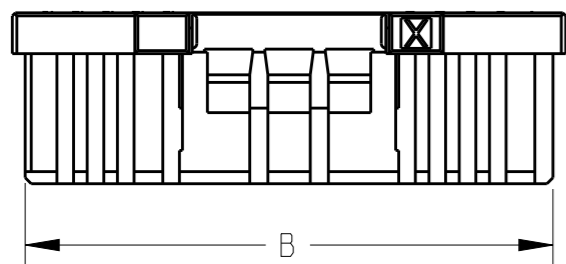
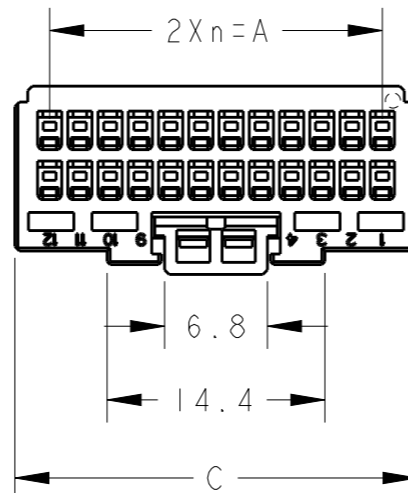
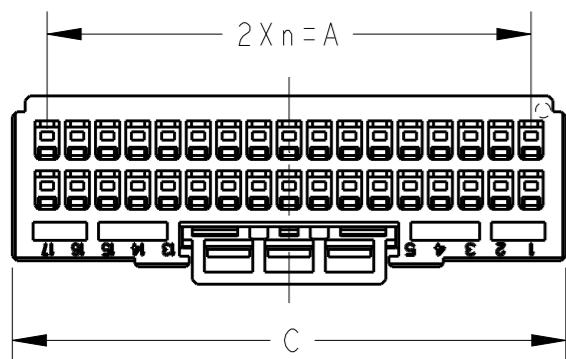

34POS(X-KEY): 1-2333134-7

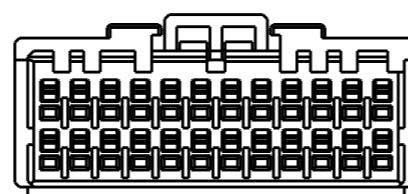
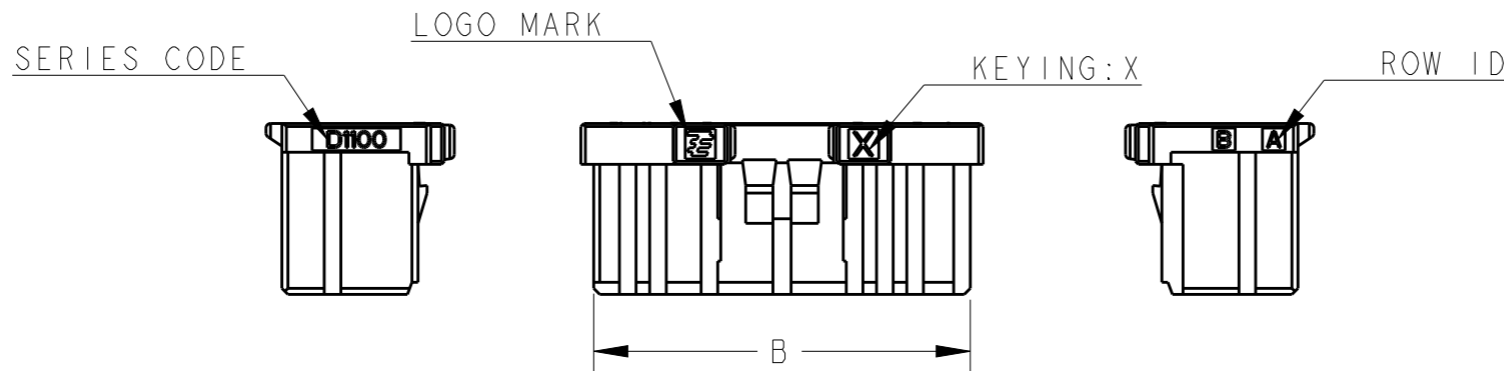

24POS(X-KEY): 1-2333134-2

THIS DRAWING IS A CONTROLLED DOCUMENT.		DWN Fisher ZHU 09-Aug-18	 TE Connectivity	
DIMENSIONS: mm		CHK Rick BIAN 09-Aug-18		
TOLERANCES UNLESS OTHERWISE SPECIFIED:		APVD Rick BIAN 09-Aug-18	NAME DYNAMIC D1100D 2.0mmPITCH	
0 PLC ±		PRODUCT SPEC 108-78268,78298	REC HSG	
1 PLC ±		APPLICATION SPEC 114-5377	22-40POS	
2 PLC ±		WEIGHT -	SIZE A3	CAGE CODE 00779
3 PLC ±		CUSTOMER DRAWING	DRAWING NO C-2333134	RESTRICTED TO -
4 PLC ±			SCALE 2:1	SHEET 3 OF 3
ANGLES ±				
MATERIAL -				
FINISH -				

SEE SHEET 1 OF 3