

# HDP26-24-23SN-L015 ✓ ACTIVE

DEUTSCH | DEUTSCH HD, DEUTSCH HDP

TE Internal #: HDP26-24-23SN-L015

Housing for Female Terminals, Wire-to-Wire, 23 Position, Sealable, Black, Wire & Cable, Power & Signal, Cable Mount (Free-Hanging), Hybrid

[View on TE.com >](#)



Connectors > Automotive Connectors > Automotive Housings > DEUTSCH HDP20 Housings



Connector & Housing Type: **Housing for Female Terminals**

Mating Pin Diameter: **1.59 mm [ .063 in ]**

Connector System: **Wire-to-Wire**

Number of Positions: **23**

Sealable: **Yes**

[All DEUTSCH HDP20 Housings \(324\)](#)

## Features

### Product Type Features

Connector Shape	Circular
Connector & Housing Type	Housing for Female Terminals
Connector System	Wire-to-Wire
Sealable	Yes
Hybrid Connector	No
Primary Locking Feature	Contact Retainer
Connector & Contact Terminates To	Wire & Cable

### Configuration Features

Blank Cavity Position	0
Connector Modification	Threaded Adapter
Connector Seal Code	N Seal
Number of Positions	23

### Electrical Characteristics

Operating Voltage	250 VAC
Nominal Voltage Architecture	12 V, 24 V, 48 V

### Body Features



Cable Exit Angle	180°
Primary Product Color	Black

### Contact Features

Contact Size	Size 16
Contact Type	Socket
Mating Pin Diameter	1.59 mm[.063 in]
Contact Current Rating (Max)	13 A

### Mechanical Attachment

Terminal Position Assurance	No
Strain Relief	Add By Accessory
Mating Alignment Type	Guide Slot
Mating Alignment	With
Connector Mounting Type	Cable Mount (Free-Hanging)

### Housing Features

Housing Material	PA GF
------------------	-------

### Dimensions

Connector Height	49.53 mm[1.95 in]
Product Width	49.53 mm[1.95 in]
Product Length	55.45 mm[2.183 in]
Accepts Insulation Diameter Range	2.54 – 3.4 mm[.1 – .134 in]

### Usage Conditions

Operating Temperature (Max)	125 °C[257 °F]
Operating Temperature Range	-55 – 125 °C[-67 – 257 °F]

### Operation/Application

Circuit Application	Power & Signal
---------------------	----------------

### Industry Standards

Degree of Protection	IP67
UL Flammability Rating	20mm Flame Test per Standard UL-94

### Packaging Features

Packaging Quantity	160
Packaging Method	Box



Other

Serviceable	Yes
Connector Position Assurance Capable	No

Product Compliance

[For compliance documentation, visit the product page on TE.com>](#)

EU RoHS Directive 2011/65/EU	Compliant
EU ELV Directive 2000/53/EC	Compliant
China RoHS 2 Directive MIIT Order No 32, 2016	No Restricted Materials Above Threshold
EU REACH Regulation (EC) No. 1907/2006	Current ECHA Candidate List: JAN 2023 (233) Candidate List Declared Against: JAN 2023 (233) Does not contain REACH SVHC
Halogen Content	Not Low Halogen - contains Br or Cl > 900 ppm.
Solder Process Capability	Not reviewed for solder process capability

Product Compliance Disclaimer

This information is provided based on reasonable inquiry of our suppliers and represents our current actual knowledge based on the information they provided. This information is subject to change. The part numbers that TE has identified as EU RoHS compliant have a maximum concentration of 0.1% by weight in homogenous materials for lead, hexavalent chromium, mercury, PBB, PBDE, DBP, BBP, DEHP, DIBP, and 0.01% for cadmium, or qualify for an exemption to these limits as defined in the Annexes of Directive 2011/65/EU (RoHS2). Finished electrical and electronic equipment products will be CE marked as required by Directive 2011/65/EU. Components may not be CE marked. Additionally, the part numbers that TE has identified as EU ELV compliant have a maximum concentration of 0.1% by weight in homogenous materials for lead, hexavalent chromium, and mercury, and 0.01% for cadmium, or qualify for an exemption to these limits as defined in the Annexes of Directive 2000/53/EC (ELV). Regarding the REACH Regulation, the information TE provides on SVHC in articles for this part number is based on the latest European Chemicals Agency (ECHA) 'Guidance on requirements for substances in articles' posted at this URL: <https://echa.europa.eu/guidance-documents/guidance-on-reach>

Compatible Parts

 <p>TE Part # CAT-H3910-B128 DEUTSCH HD10 Backshells</p>	 <p>TE Part # CAT-H396-CH8172 DEUTSCH HDP20 Housings</p>	 <p>TE Part # CAT-D48-SP729 DEUTSCH Sealing Plugs</p>	 <p>TE Part # 0411-291-1405 EXT TOOL, SIZE 16, 14-16 AWG, N, GRN</p>
---	---	--	---



### Also in the Series | DEUTSCH HD

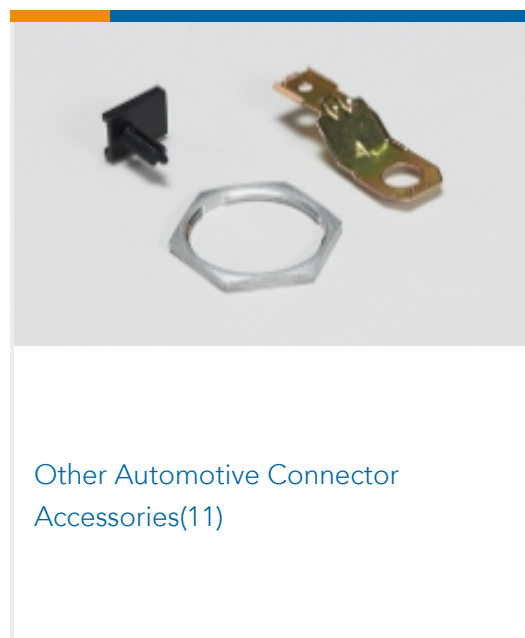
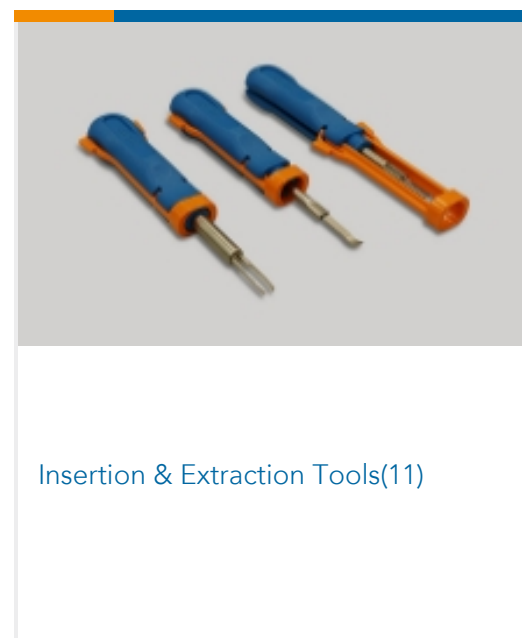
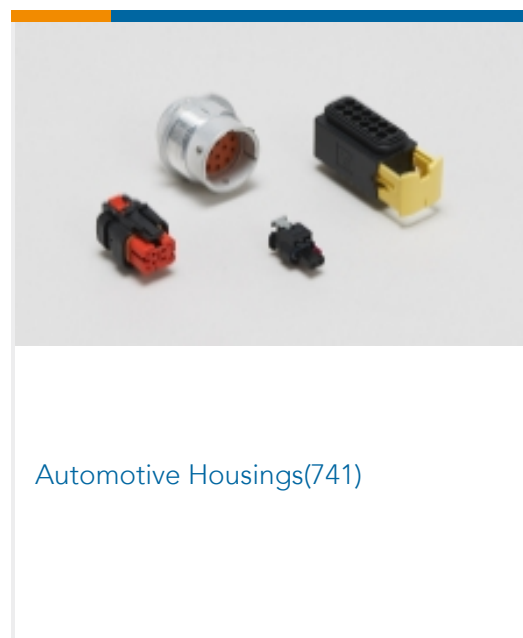
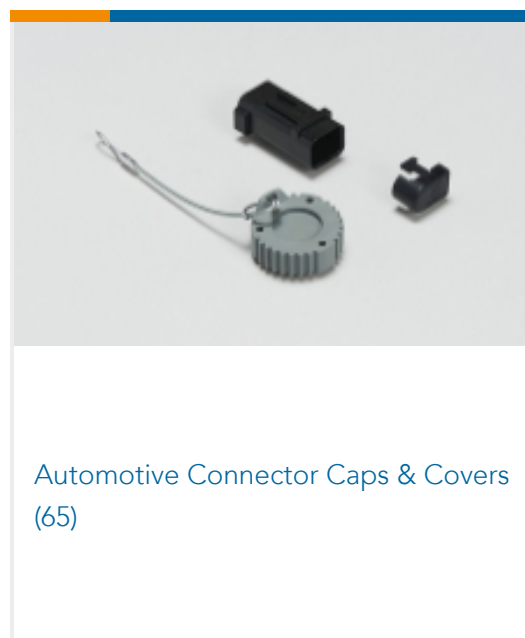

### Also in the Series | DEUTSCH HDP



Automotive Connector Caps & Covers (12)

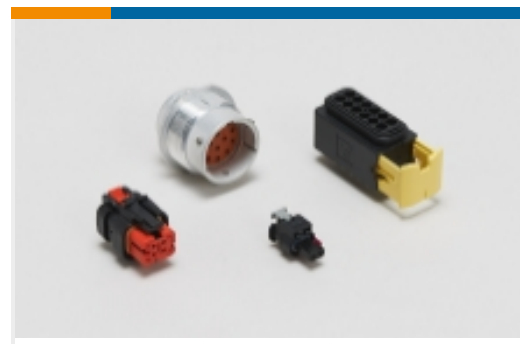

Automotive Housings(331)



Automotive Seals & Cavity Plugs(1)

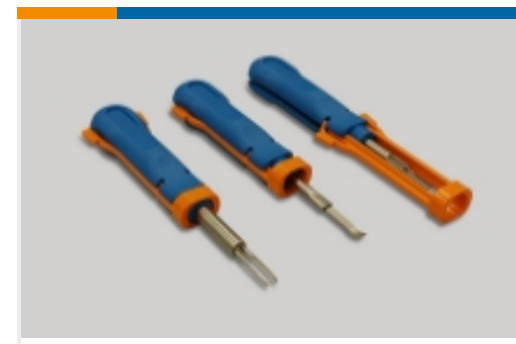

Insertion & Extraction Tools(11)



Other Automotive Connector Accessories(5)

## Customers Also Bought



TE Part #M902-2054  
COMP NUT, 6/9/24SZ,CBL SZ .570-.710,HD10

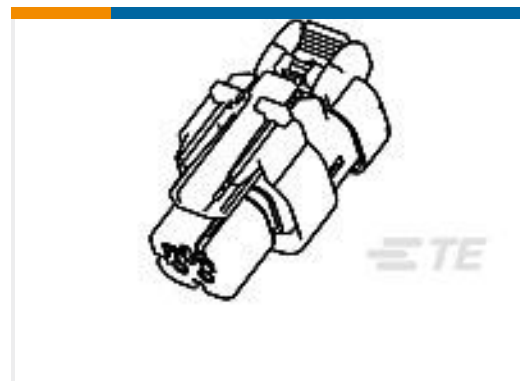

TE Part #776523-3  
AS 16, 3P PLUG ASSY, RD, KEY 3



TE Part #179595-1  
AMP POWER D/LOCK TAB CONT. L/P



TE Part #HD10-9-96PE-B009  
SQ FG REC ASM



TE Part #DT04-3P-LE12  
REC, 3P, BLK, N, XCAP, FLANGE



TE Part #HDB36-24-91SN-059  
BR AWY PL ASM,MC



TE Part #M902-2244  
BKSHL, 24SZ, CBL SZ .570-.710, HDP L015



TE Part #DTM06-2S-EE03  
PLG, 2P, BLK, N, XCAP



TE Part #5580604008  
VPB-1-0-SP-CS5444



TE Part #2267473-1  
SIZE 11 PERIPHERAL SEAL, CPC

## Documents



### Product Drawings

[PLG, 23P, BLK, N, THD, 16, S](#)

English

---

### CAD Files

[3D PDF](#)

3D

Customer View Model

[ENG\\_CVM\\_CVM\\_HDP26-24-23SN-L015\\_B.2d\\_dxf.zip](#)

English

Customer View Model

[ENG\\_CVM\\_CVM\\_HDP26-24-23SN-L015\\_B.3d\\_igs.zip](#)

English

Customer View Model

[ENG\\_CVM\\_CVM\\_HDP26-24-23SN-L015\\_B.3d\\_stp.zip](#)

English

By downloading the CAD file I accept and agree to the [Terms and Conditions](#) of use.

---

### Datasheets & Catalog Pages

[CONNECTOR SELECTOR](#)

English

---

### Product Specifications

[Application Specification](#)

English

---

### Agency Approvals

[UL Report](#)

English