

EVAL-AD7768FMCZ Rev. A - Component Side View
Layer 1 - Component Side (Primary)

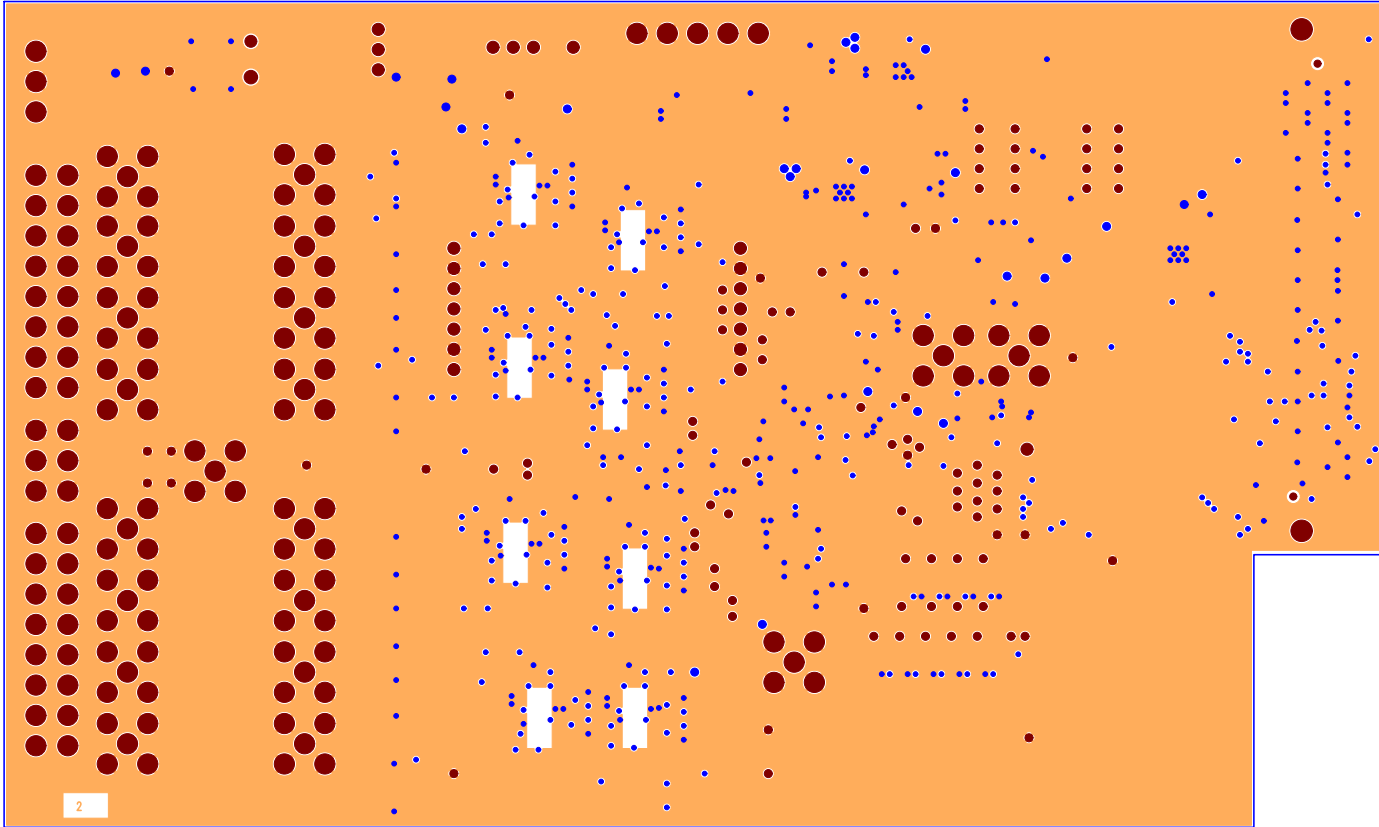

EVAL-AD7768FMCZ Rev. A - Component Side View
Layer 2 - GND Planes

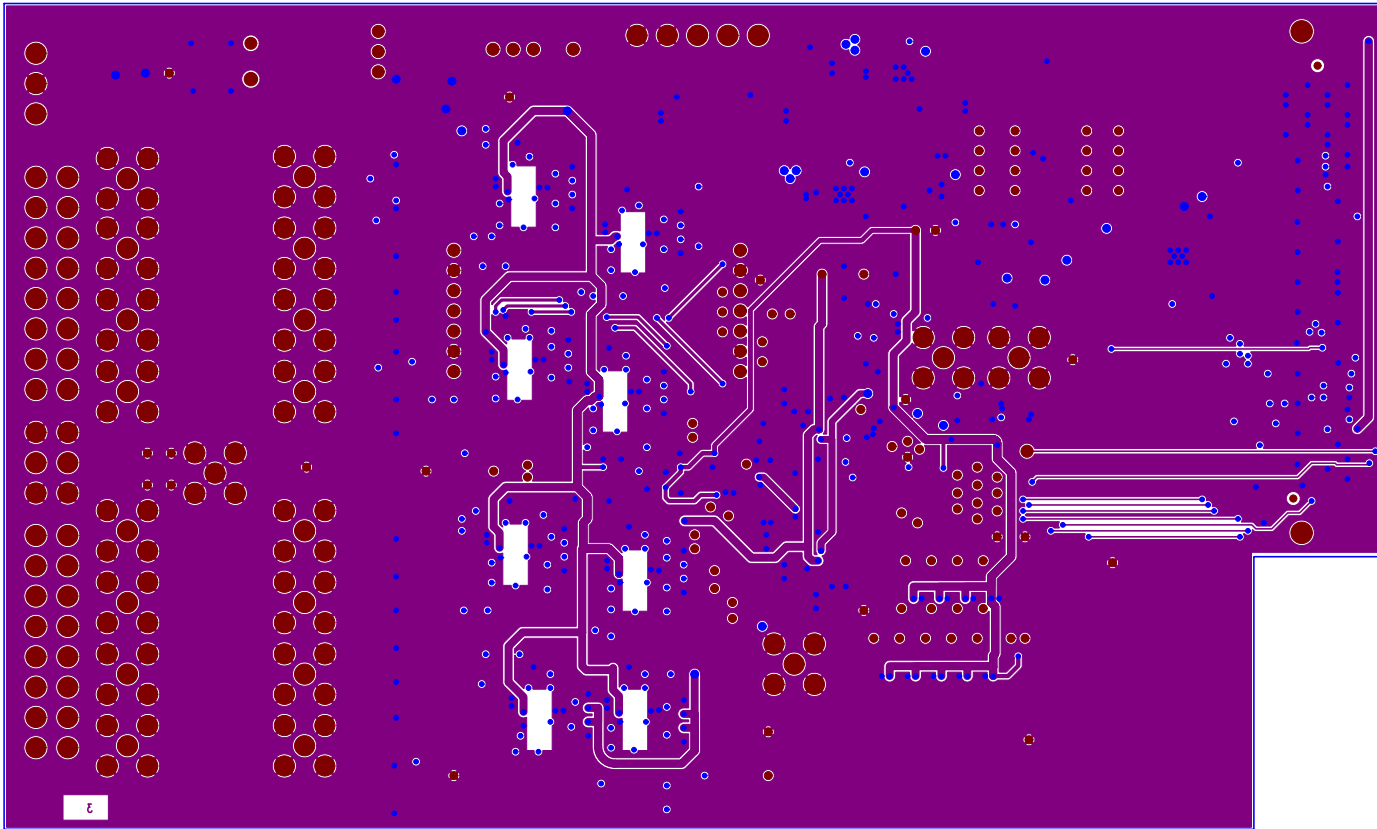



EVAL-AD7768FMCZ Rev. A – Component Side View



Layer3 - Power Traces & GND Planes

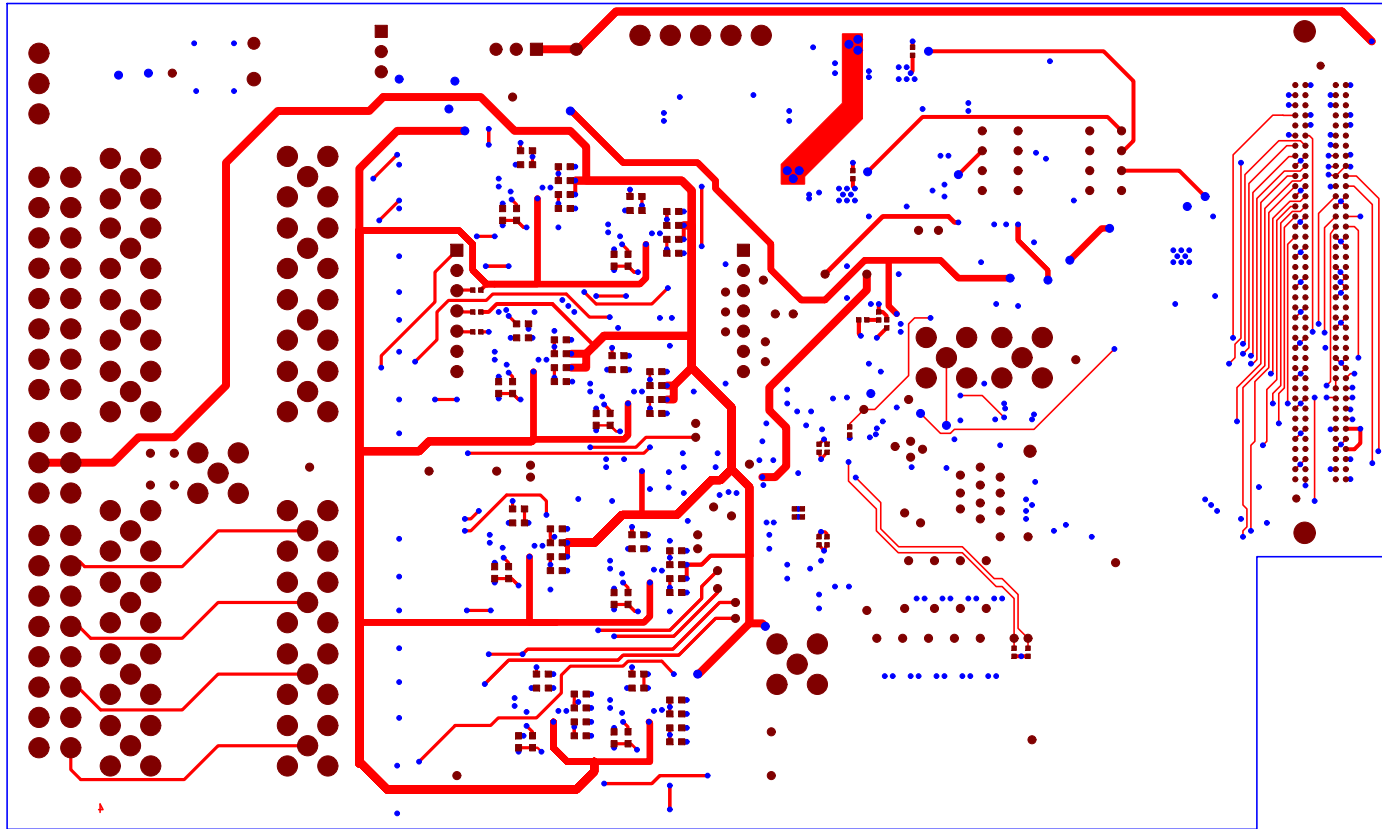

EVAL-AD7768FMCZ Rev. A - Component Side View



Layer 4 - Solder Side (Secondary)

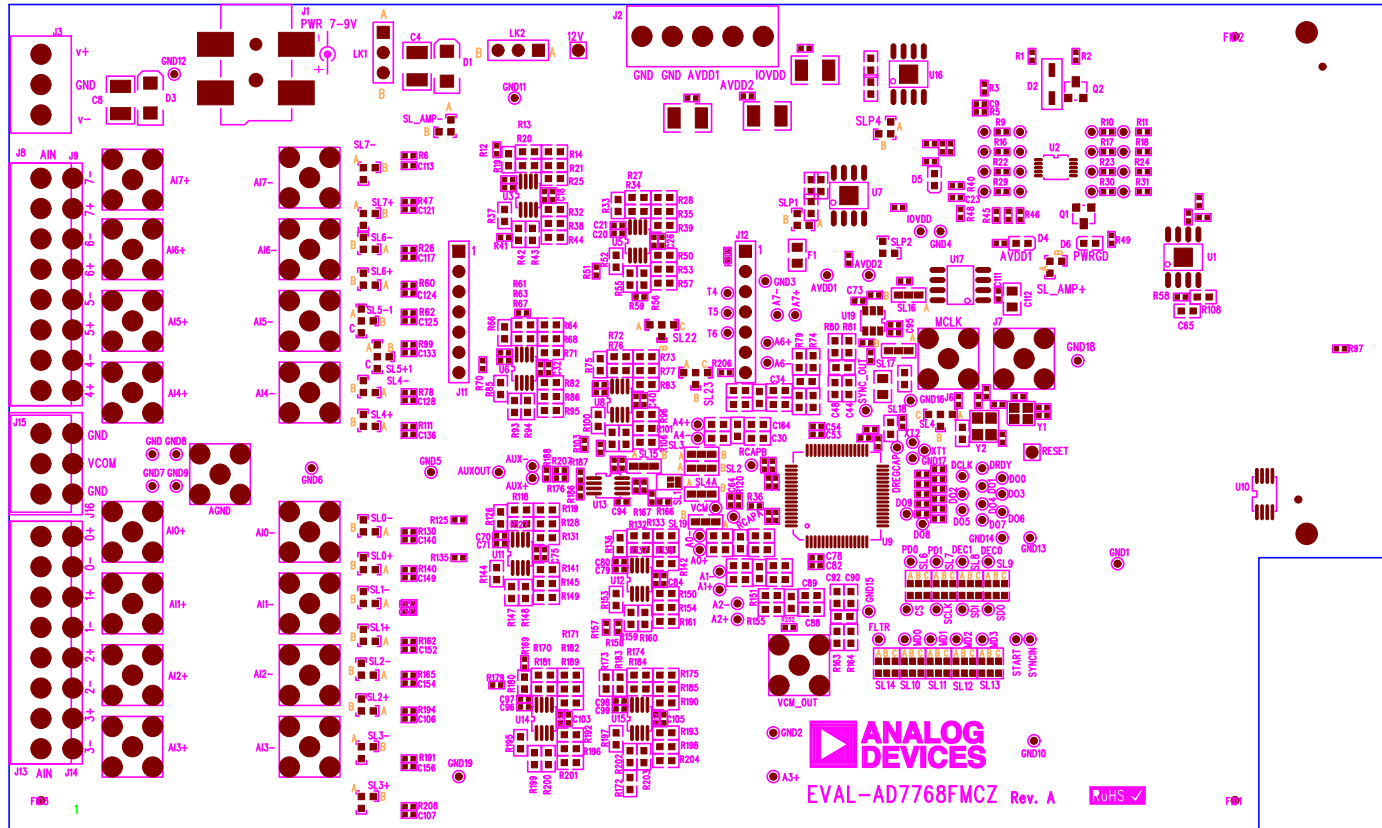

EVAL-AD7768FMCZ Rev. A – Component Side View
 Layer 1 – Component Side (Primary)

Silkscreen Top

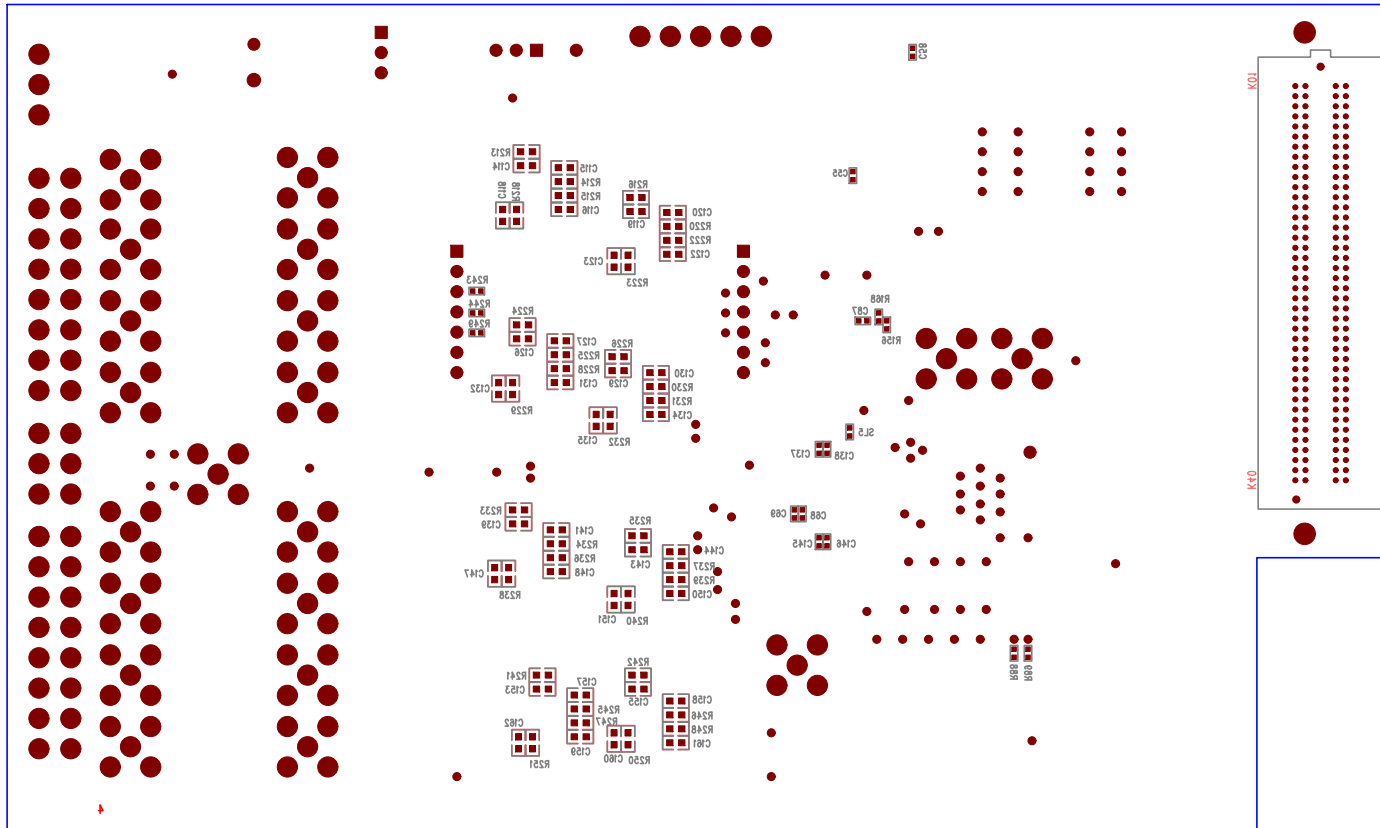

EVAL-AD7768FMCZ Rev. A – Component Side View

Layer 4 – Solder Side (Secondary)

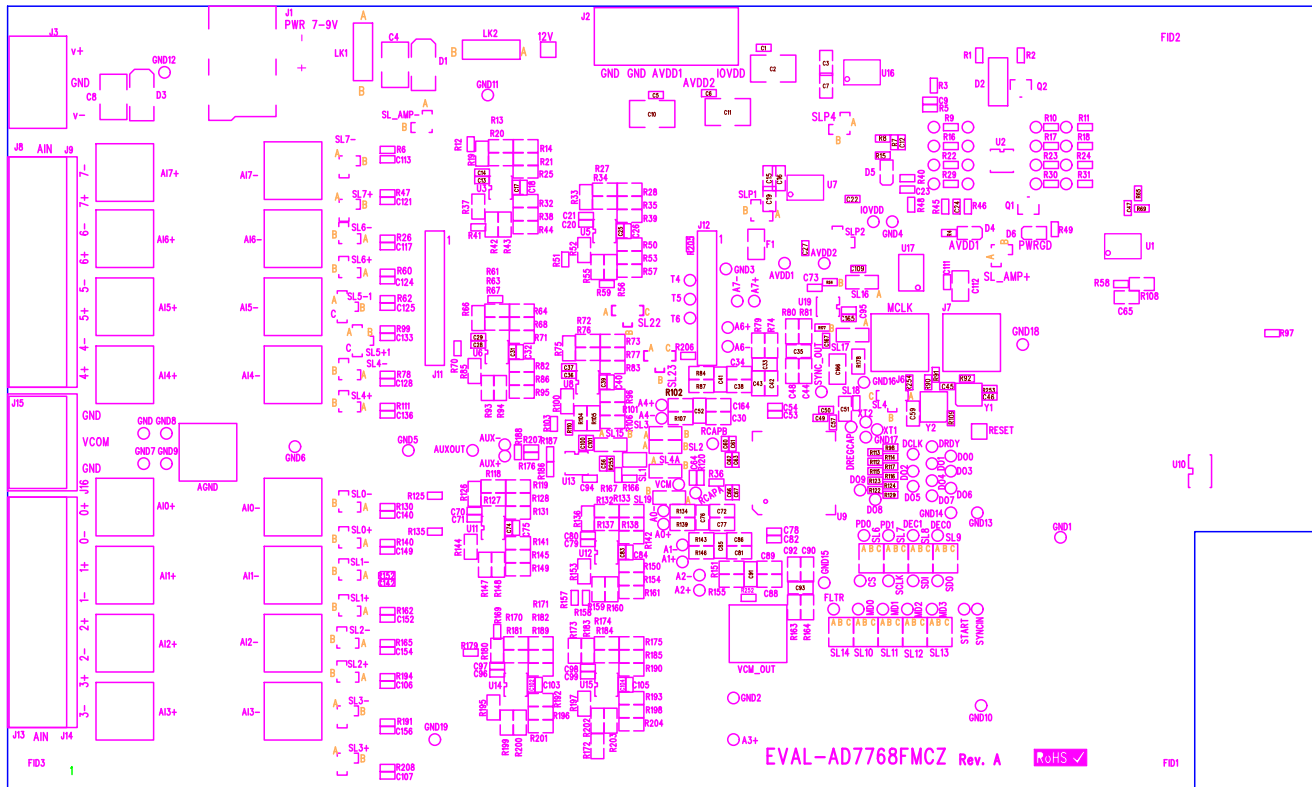

EVAL-AD7768FMCZ Rev. A – Component Side View
 Layer 1 – Component Side (Primary) Silkscreen Top

Assembly Drawing (Primary)

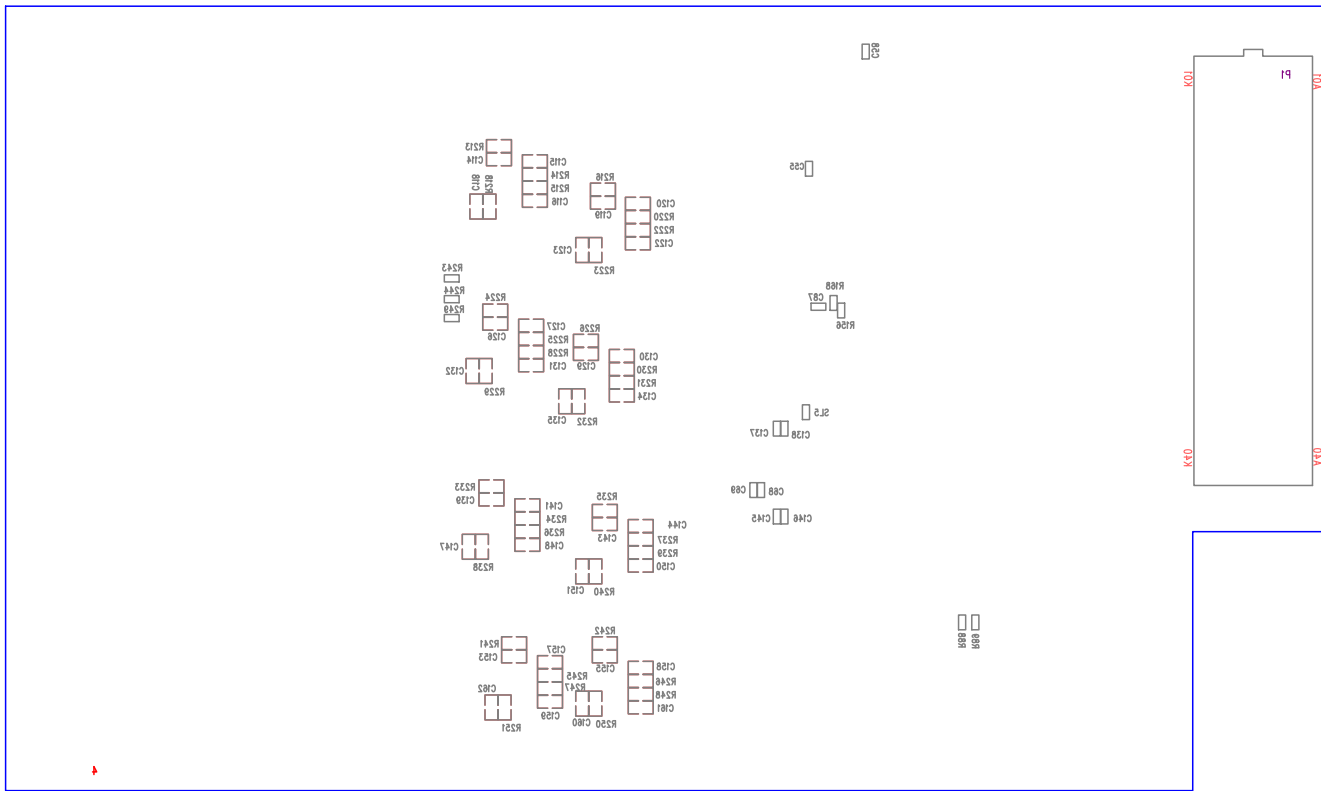

EVAL-AD7768FMCZ Rev. A – Component Side View

Layer 4 – Solder Side (Secondary)

Silkscreen Bottom

Assembly Drawing (Secondary)