

Evaluating the AD74115H Single-Channel, Software Configurable Input and Output with HART Modem**FEATURES**

- ▶ Fully featured evaluation board for the [AD74115H](#)
- ▶ System power and isolation provided by the [ADP1034](#)
- ▶ On-board 2.5 V [ADR4525](#) reference
- ▶ SPI compatible
- ▶ PC-based software for control
- ▶ No-OS MBED drivers providing example code in C

EVALUATION KIT CONTENTS

- ▶ EVAL-AD74115H-ARDZ evaluation board

EQUIPMENT NEEDED

- ▶ [EVAL-SDP-CK1Z \(SDP-K1\)](#)
- ▶ Bench top power supply and connector cables
- ▶ PC running Windows® 7 or Windows 10 operating system

DOCUMENTS NEEDED

- ▶ AD74115H data sheet
- ▶ ADP1034 data sheet
- ▶ ADR4525 data sheet

SOFTWARE NEEDED

- ▶ AD74115H evaluation software for control
- ▶ Mbed Studio for running example code written in C programming language

GENERAL DESCRIPTION

The EVAL-AD74115H-ARDZ is a fully featured evaluation board that can be used to evaluate the features of the AD74115H in a full system solution where power and isolation are provided by the ADP1034. The AD74115H is a single-channel, software configurable, input and output device. The device has functionality for analog output, analog input, digital input, digital output, and 2-wire, 3-wire, and 4-wire resistance temperature detector (RTD) measurements integrated into a single-chip solution with a compatible serial peripheral interface (SPI).

The EVAL-AD74115H-ARDZ can be controlled via a system demonstration platform (SDP) board. The EVAL-SDP-CK1Z (SDP-K1) board allows the EVAL-AD74115H-ARDZ to be controlled via the USB port of a PC using the AD74115H evaluation software. The EVAL-AD74115H-ARDZ requires an operating supply of 4.5 V to 60 V. The PC provides power to the SDP-K1 board.

For full details on the AD74115H and ADP1034, see the AD74115H and ADP1034 data sheets, which must be consulted in conjunction with this user guide when using the EVAL-AD74115H-ARDZ.

TABLE OF CONTENTS

Features.....	1	Software Quick Start Procedures.....	6
Evaluation Kit Contents.....	1	Accessing the AD74115H Evaluation	
Equipment Needed.....	1	Software Graphical User Interface (GUI).....	6
Documents Needed.....	1	Configuring the EVAL-AD74115H-ARDZ.....	6
Software Needed.....	1	Using the Software for Evaluation.....	6
General Description.....	1	Device Function Notes.....	11
Evaluation Board Photograph	3	No-OS Driver Quick Start Procedures.....	13
Evaluation Board Hardware.....	4	Using the AD74115H No-OS Drivers.....	13
Board Layout.....	4	SPI Setup Using User Defined	
Power Supplies.....	4	Microcontroller.....	15
SPI Communication.....	4	Evaluation Board Schematics and Artwork	16
Reference Options.....	4	Ordering Information.....	21
Output Channel.....	4	Bill of Materials.....	21
Test Points.....	4	Notes.....	24
Link Configuration Options.....	4		

REVISION HISTORY**8/2022—Revision 0: Initial Version**

EVALUATION BOARD PHOTOGRAPH

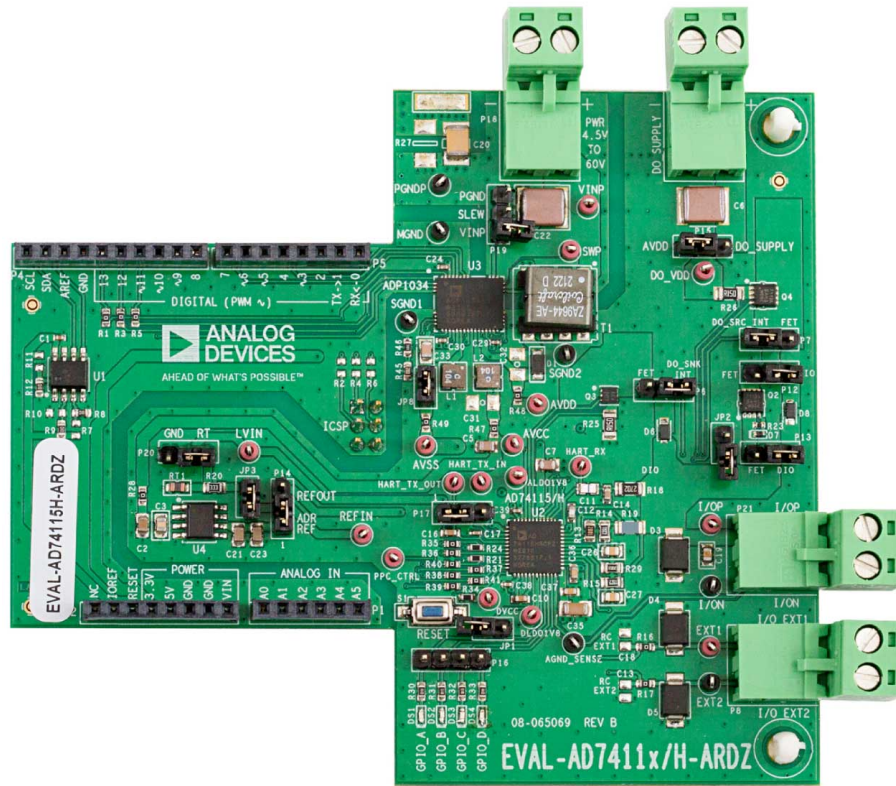

Figure 1. Evaluation Board Photograph

001

EVALUATION BOARD HARDWARE

BOARD LAYOUT

The EVAL-AD74115H-ARDZ is laid out with the following three isolated zones:

- ▶ The input power supply is applied to the power side of the EVAL-AD74115H-ARDZ.
- ▶ Communications to the EVAL-AD74115H-ARDZ are received on the microside via the SDP Arduino® header connection.
- ▶ The AD74115H and all related circuitry are on the AD74115H (or field) side of the EVAL-AD74115H-ARDZ.

Each zone is separated by a 2.2 mm isolation barrier. Figure 2 shows the three isolation zones as these zones are laid out on the EVAL-AD74115H-ARDZ.

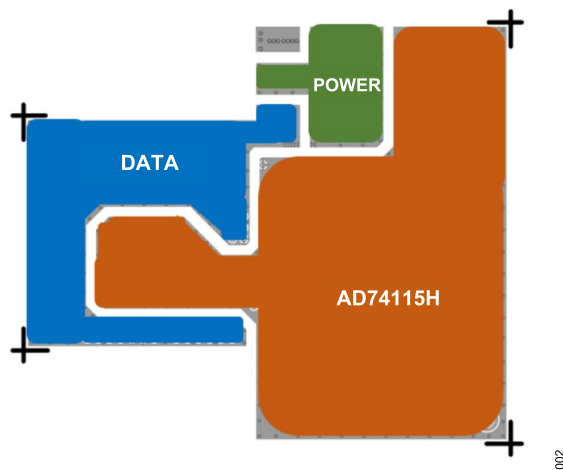

Figure 2. Isolation Zones on the EVAL-AD74115H-ARDZ

POWER SUPPLIES

The EVAL-AD74115H-ARDZ comes with a power supply connector (P18) that provides power directly to the VINP pin of the ADP1034. Set this supply between 4.5 V and 60 V, as described in the ADP1034 data sheet.

The ADP1034 generates the following isolated, resistor programmable supply voltages to the AD74115H:

- ▶ VOUT1 provides the AD74115H AVDD voltage supply, V_{AVDD} , of 24.0 V.
- ▶ VOUT2 provides the AD74115H AVCC and DVCC voltage supplies, V_{AVCC} and V_{DVCC} , of 5 V.
- ▶ VOUT3 provides the AD74115H AVSS voltage supply, V_{AVSS} , of -15 V.

The ADP1034 VOUT2 also provides power to a 2.5 V external reference (ADR4525). The ADR4525 can be used as an alternative to the AD74115H on-chip reference.

The ADP1034 provides all the necessary power to the AD74115H to perform the analog output, analog input, digital input, and digital output functions.

However, if the digital output function is required to provide more than 100 mA of continuous current, an additional external power supply is required. The DO_SUPPLY connector can provide this power supply directly to the digital output circuitry on the AD74115H isolated side of the EVAL-AD74115H-ARDZ. See the Digital Output section for details on how to configure for digital output functionality. The digital output schematic entry is shown in Figure 23.

SPI COMMUNICATION

The SDP-K1 board handles the communication to the EVAL-AD74115H-ARDZ via the PC. The SDP-K1 is connected to the EVAL-AD74115H-ARDZ using the Arduino header connections. The SDP-K1 board controls the SPI communication and the RESET pin (driven high) and monitors the ALERT pin and ADC_RDY pin of the AD74115H. ALERT, ADC_RDY, RESET, and all four SPI pins, are isolated using the ADP1034.

A reset button (S1) is also available on the EVAL-AD74115H-ARDZ to manually reset the AD74115H.

REFERENCE OPTIONS

By default, the EVAL-AD74115H-ARDZ is configured to use an external reference, the ADR4525. Alternatively, the AD74115H on-chip reference can be used by shorting the REFOUT pin to the REFIN pin. The appropriate jumpers must be connected if using the external reference. See Table 1 for the specific jumper connections.

OUTPUT CHANNEL

The AD74115H channel is configured as described in the AD74115H data sheet. Figure 22 shows the schematic details for the channel.

There are two screw terminal blocks on the EVAL-AD74115H-ARDZ. Use the I/OP and I/ON connector (P21) to connect the desired load to the AD74115H channel. To apply stimulus to the two auxiliary high voltage sense pins, SENSE_EXT1 and SENSE_EXT2, use the I/O_EXT1 and I/O_EXT2 connector (P8).

TEST POINTS

Multiple test points are available on the EVAL-AD74115H-ARDZ for all critical pins and on the connector screw terminals. The test points are located next to the relevant pins on the AD74115H.

LINK CONFIGURATION OPTIONS

The JPx and Px jumpers must be set properly for operation of the EVAL-AD74115H-ARDZ. The functions and default states of these options are listed in Table 1. Before applying power and signals to the EVAL-AD74115H-ARDZ, ensure that all links are set to the default positions, as defined in Table 1.

EVALUATION BOARD HARDWARE

Table 1. EVAL-AD74115H-ARDZ Jumper Functionality

Link	Function	Default Position
JP1	The AD74115H charge pump is disconnected from AVSS. If using the charge pump of the AD74115H, close JP1 to connect the charge pump voltage to the AVSS pin. JP1 and JP8 cannot be closed at the same time.	Open
JP3	REFIN provides power to the on-board thermistor.	Closed
JP8	Connect the VOUT3 pin of the ADP1034 to the AVSS supply pin of the AD74115H. If using the charge pump of the AD74115H, open JP8 to disconnect the external power source from AVSS. JP1 and JP8 cannot be closed at the same time.	Closed
P14	Connect the REFIN pin of the AD74115H to the ADR4525 , external precision reference. To use the internal reference, connect Pin 2 to Pin 3.	Pin 1 to Pin 2
P15	The DO_VDD pin of the AD74115H is powered by the AVDD supply (that is, powered by the ADP1034). If the external digital output functionality is required, apply an external power supply to the DO_SUPPLY terminal. Configure P15 to connect the DO_VDD pin of the AD74115H to the external DO_SUPPLY (Pin 1 to Pin 2).	Pin 2 to Pin 3
P17	Connect the AD74115H HART_TX_OUT signal to the HART_TX_IN signal.	Pin 1 to Pin 2
P19	The ADP1034 SLEW pin is floating. For slower slew rates, tie the SLEW pin to the VINP pin of the ADP1034 or ground.	Open
P20	The LVIN pin of the AD74115H is switched to measure the thermistor voltage.	Pin 2 to Pin 3
JP2, P6, P7, P12, P13	Digital output connectors. By default, the digital output circuitry is configured for internal digital output functionality (for currents up to 100 mA, continuous). Full details of the connections required for each function are included in Table 2 .	Configured for an internal digital output

SOFTWARE QUICK START PROCEDURES

ACCESSING THE AD74115H EVALUATION SOFTWARE GRAPHICAL USER INTERFACE (GUI)

A **MyAnalog** account is required to gain access to the **AD74115H** evaluation software, which is used to communicate with the EVAL-AD74115H-ARDZ. Register for a **MyAnalog** account [here](#). Once your account is activated, contact the Analog Devices, Inc., [sales](#) team to request access to the AD74115H evaluation software.

Download and extract the file from the **Special Resources** section in your **MyAnalog** account to your PC. Run the **AD74115H_Eval_Software_setup** executable. Once installation is complete, restart the PC before launching the GUI.

CONFIGURING THE EVAL-AD74115H-ARDZ

To set up the EVAL-AD74115H-ARDZ, take the following steps:

1. Set VIO_ADJUST to 3.3 V using the P14 header on the [SDP-K1](#) board.
2. Connect a USB cable to the PC and then to the SDP-K1 board.
3. Connect the SDP-K1 board to the EVAL-AD74115H-ARDZ.
4. Power up the EVAL-AD74115H-ARDZ with the relevant power supplies.

If not opened already, open the AD74115H evaluation software GUI. The GUI displays a green indicator to confirm that the AD74115H is connected (see [Figure 3](#)).

5. Click **START** to begin configuration.

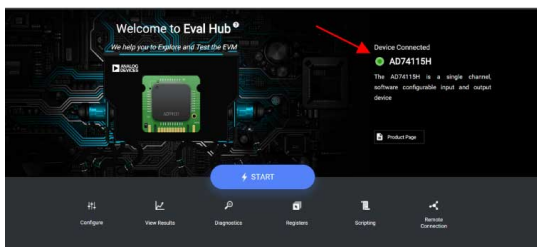

Figure 3. AD74115H Evaluation Software Start Page

USING THE SOFTWARE FOR EVALUATION

Configure Tab

Use The **Configure** tab to configure the channel of the AD74115H. The channel can be configured as described in the AD74115H data

sheet. Use the dropdown menus to configure the required function (see [Figure 4](#)).

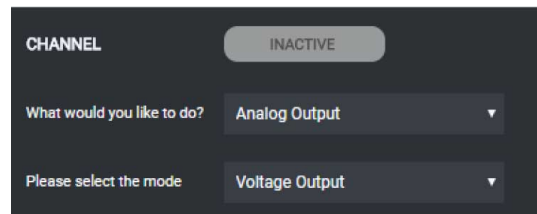

Figure 4. Channel Function View

When the function is selected, the associated advanced settings are displayed (see [Figure 5](#)). Click **Apply** to update the device with the selected settings.

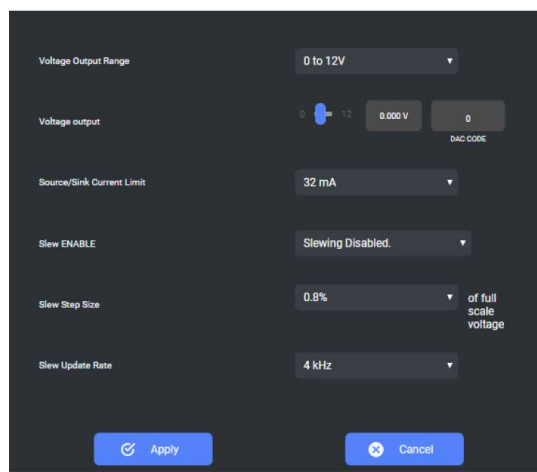
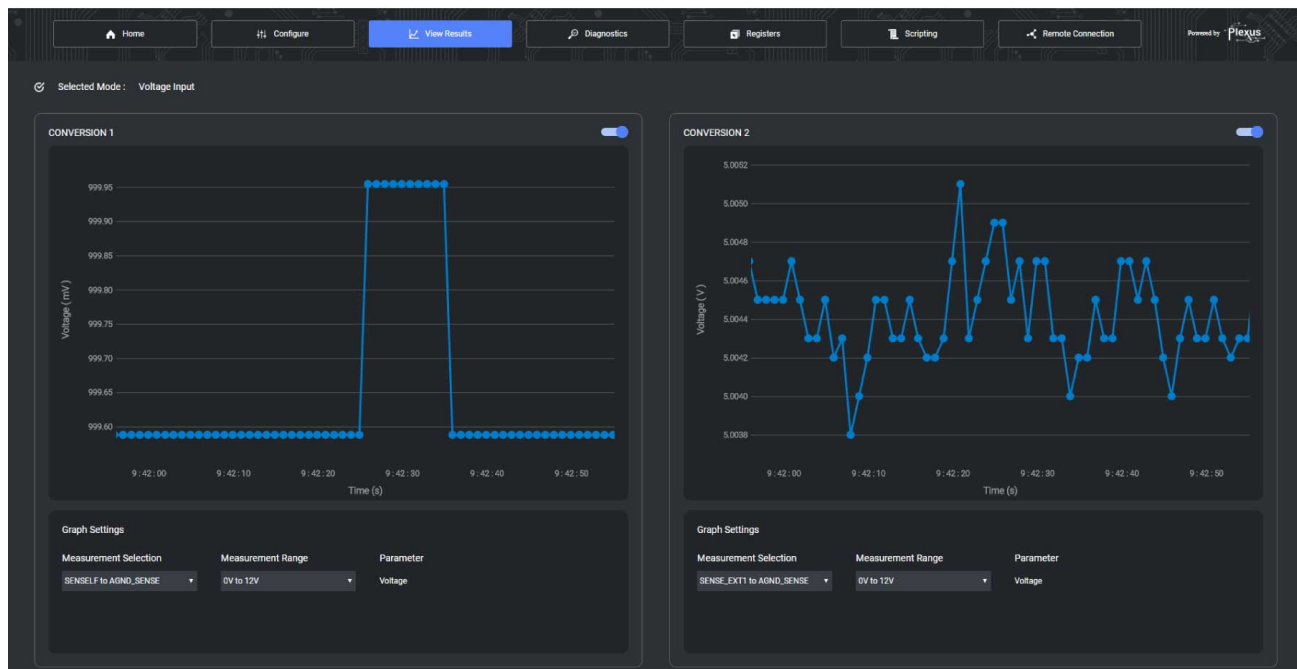

Figure 5. Channel Function Advanced Settings

View Results Tab

When the channel configuration is applied, click the **View Results** tab to see the channel monitor. Results from the selected channel measurement are shown in the CONVERSION 1 graph. CONVERSION 2 can also be configured using the available dropdown menu. This conversion is typically used for auxiliary measurements (see [Figure 6](#)).

SOFTWARE QUICK START PROCEDURES



900

Figure 6. View Results Tab

SOFTWARE QUICK START PROCEDURES

Diagnostics Tab

In the **Diagnostics** tab, click the test points to enable measurements of the required diagnostics. Up to four diagnostics can be

enabled at once. The alert bits are displayed in the right-hand panel. An alert bit illuminates in red if an alert condition is present. See [Figure 7](#) for a snapshot of the **Diagnostics** tab.

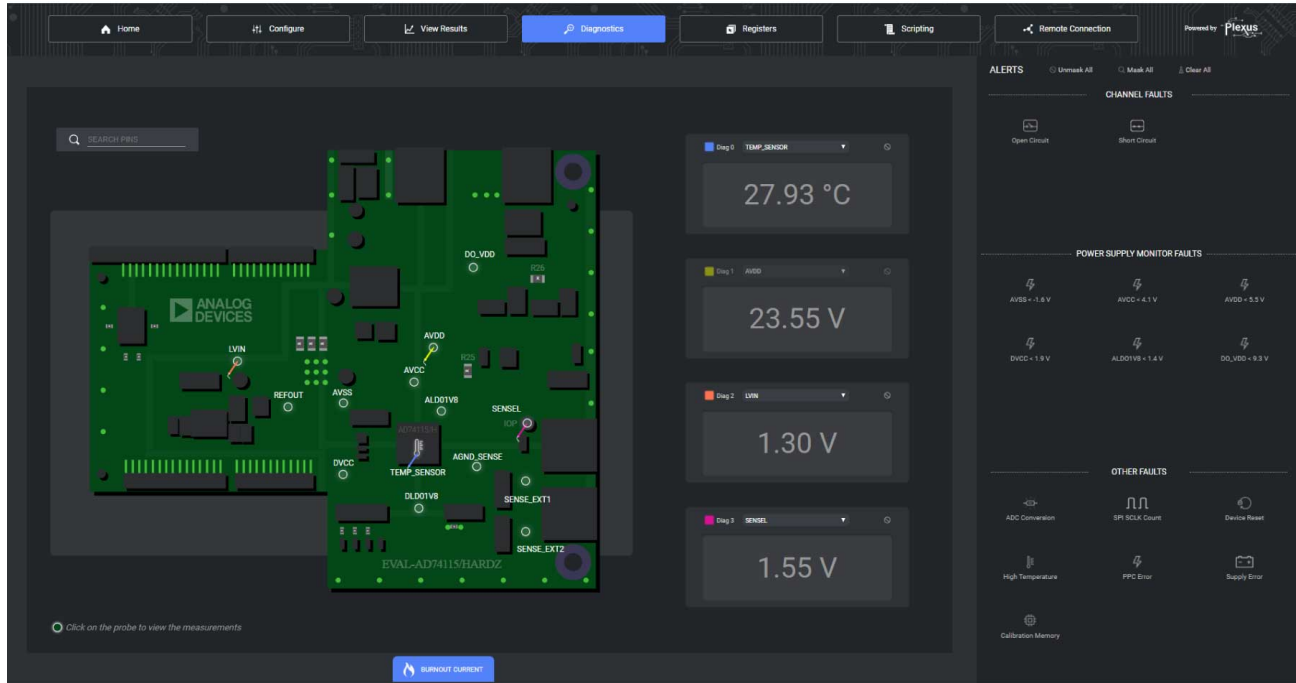

Figure 7. Diagnostics Tab

007

SOFTWARE QUICK START PROCEDURES

Register Map

The register map can also be used to interface directly to the [AD74115H](#).

The immediate mode allows register writes to execute as soon as the bit fields are changed.

In deferred mode, to apply register edits to the AD74115H click the **Write Register** button. To manually read from the device in deferred mode, click the **Read Register** button (see [Figure 8](#)).

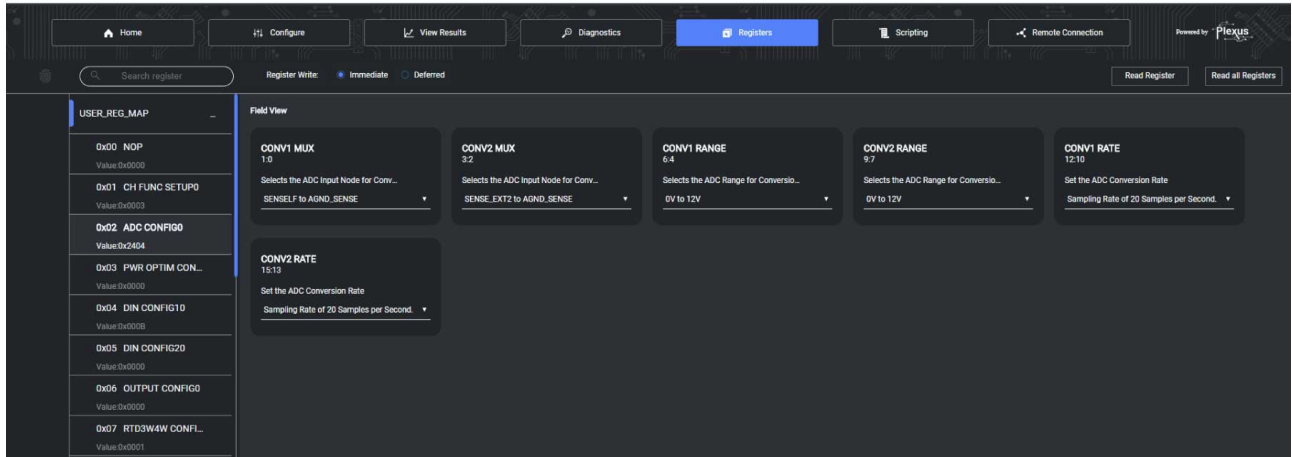

Figure 8. Register Map Display

000

SOFTWARE QUICK START PROCEDURES

Scripting Tab

The scripting tool allows simple scripts to be programmed, executed, and saved. When a script is written in the left panel, click the **Run** icon (see [Figure 9](#)) to execute the writes to the AD74115H. The panel on the right side of the page displays the results from any readbacks executed in the script. Commands supported by this

page are limited to write, read, delay and for loop operations (see [Figure 10](#)). The scripting feature validates the written syntax. The user can save and load configurations.



Figure 9. Run Icon

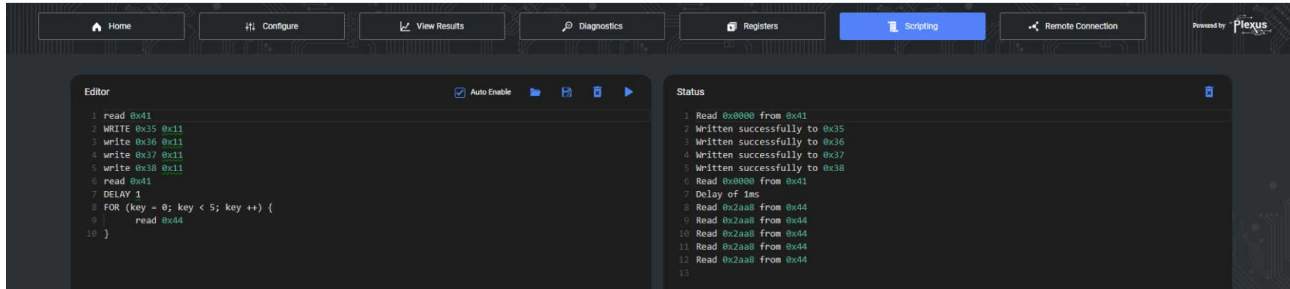

Figure 10. Scripting Page Display

010

SOFTWARE QUICK START PROCEDURES

DEVICE FUNCTION NOTES

The following sections outline the load connectivity and hardware requirements for the various functions of the [AD74115H](#).

Analog Outputs, Analog Input, and Digital Input Functions

Connect all loads between the I/OP and I/ON screw terminals.

Use the channel view dropdown menus to select the function of choice and configure the advanced settings as required.

Resistance Measurements

Take the 2-wire resistance measurements between the I/OP and I/ON screw terminals.

When measuring the 3-wire resistance temperature detectors (RTDs) with the evaluation GUI, connect the RTD as follows:

- ▶ Connect Lead 1 of the 3-wire RTD to the I/OP screw terminal.
- ▶ Connect Lead 2 of the 3-wire RTD to the SENSE_EXT1 terminal.
- ▶ Connect Lead 3 of the 3-wire RTD to the I/ON screw terminal.

When measuring the 4-wire RTDs with the evaluation GUI, connect the RTD as follows:

- ▶ Connect Lead 1 of the 4-wire RTD to I/OP terminal and connect its sense, Lead 2, to the SENSE_EXT2 terminal.
- ▶ Connect Lead 3 of the 4-wire RTD to I/ON terminal and connect its sense, Lead 4, to the SENSE_EXT1 terminal.

For the best 3-wire and 4-wire measurement results, configure the excitation current and ADC measurement range to suit the

chosen RTD range. Three measurement ranges are described in the AD74115H data sheet, along with the proposed measurement settings.

Digital Output

The [ADP1034](#) can provide the power required to power the internal digital output function. When using the internal digital output function, connect the DO_VDD power supply to be AVDD by connecting Pin 2 to Pin 3 of P15.

Configure the EVAL-AD74115H-ARDZ board correctly before setting the AD74115H as a digital output. The jumper settings required for the various internal digital output functions are outlined in [Table 2](#).

For the external digital output, an additional power supply is required to provide current to the external field-effect transistors (FETs).

When using the external digital output function, connect the DO_VDD power supply to be DO_SUPPLY terminal by connecting Pin 1 to Pin 2 of P15.

Take care with the external FETs because these FETs can be thermally damaged if short-circuit times are set too long. The FETs chosen for the external digital output function are the following:

- ▶ SI7113ADN-T1-GE3: P-channel metal-oxide semiconductor (PMOS) FET for sourcing current
- ▶ SIA416DJ-T1-GE3: N-channel MOS (NMOS) FET for sinking current

Table 2. Jumper Connections for Digital Output Modes

Digital Output Function	JP2	P6	P7	P12	P13
Internal Digital Output	Open	Pin 1 to Pin 2	Pin 1 to Pin 2	Pin 2 to Pin 3	Pin 2 to Pin 3
External Digital Output	Open	Pin 2 to Pin 3	Pin 2 to Pin 3	Pin 2 to Pin 3	Pin 2 to Pin 3
External Digital Output with Smart Diode	Closed	Pin 2 to Pin 3	Pin 2 to Pin 3	Pin 1 to Pin 2	Pin 1 to Pin 2

SOFTWARE QUICK START PROCEDURES

Differential Voltage Measurements

A differential voltage can be measured between the SENSE_EXT1 and SENSE_EXT2 terminals.

In the **View Results** Tab, configure the AD74115H for differential measurements as follows:

- ▶ Enable Conversion 2.
- ▶ Select the SENSE_EXT2 to SENSE_EXT1 measurement.
- ▶ The ± 12 V provides the widest measurement range.

Figure 11 shows the Conversion 2 results when SENSE_EXT1 is stepped from +4 V to -3 V and back to 0 V while SENSE_EXT2 is at 5 V.

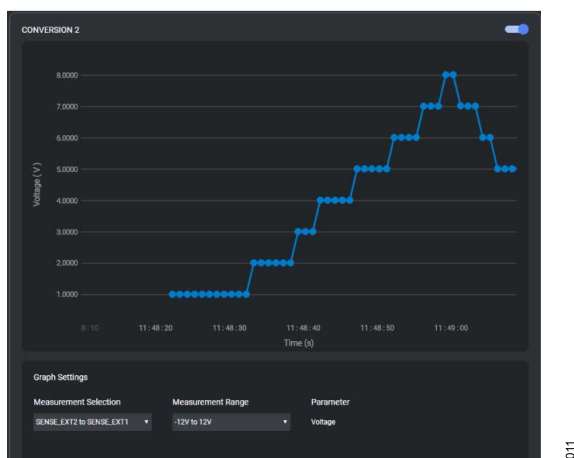

Figure 11. Differential Voltage Measurement Example

Programmable Power Control

The ADP1034 provides programmable power control (PCC) that allows dynamically changing the value of V_{AVDD} . Changing the value of V_{AVDD} results in power savings. The value of V_{AVDD} is set via a one-wire serial bus between the ADP1034 and the AD74115H.

The GUI allows users to change the V_{AVDD} value using the panel at the top (see Figure 12). Modify the desired AVDD value and press **Apply** button.

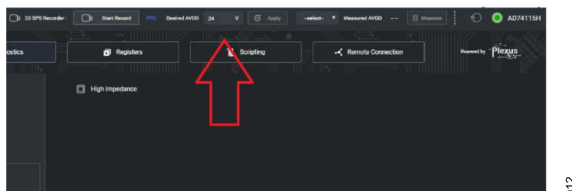

Figure 12. Top Panel of the AD74115H Evaluation GUI

The EVAL-AD74115H-ARDZ is designed with the maximum output voltage up to 24 V of V_{AVDD} . However, the ADP1034 can provide up to 28 V for V_{AVDD} , which is achieved by changing the Feedback 1 (FB1) resistor values of the ADP1034. Recommended values can be found at ADP1034 data sheet. This modification results in the

Desired AVDD value displayed in the GUI no longer corresponding to real value. For this reason, using the direct write to the PPC_TX register with Address 0x66 is recommended.

NO-OS DRIVER QUICK START PROCEDURES

USING THE AD74115H NO-OS DRIVERS

The [AD74115H](#) No-OS driver allows users to see how the AD74115H can be controlled via the SPI using the microcontroller.

For demonstration purposes, the microcontroller on the [SDP-K1](#) board was used. This setup is described in the [Mbed No-OS Drivers Project Setup](#) section.

See the [SPI Setup Using User Defined Microcontroller](#) section for information on the hardware setup needed for using your own microcontroller.

Mbed No-OS Drivers Project Setup

Take the following steps to set up the Mbed No-OS drivers:

1. Download and install Mbed Studio for the desktop by going to the Mbed Studio website.
2. Create a new project based on the example project, **mbed-os-example-blinky**. Add the **New Program** name, AD74115H, in this example (see [Figure 13](#)).

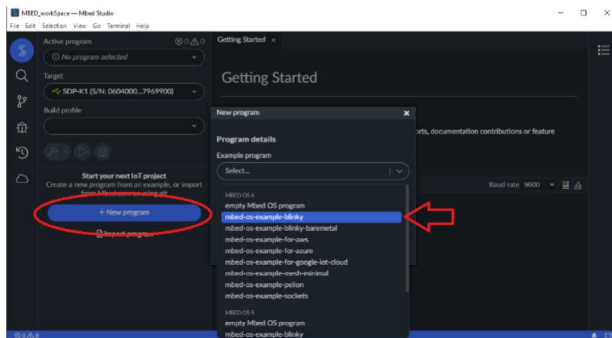

Figure 13. Create MBED Project

3. Choose the SDP-K1 board as the platform or target hardware (see [Figure 14](#)).

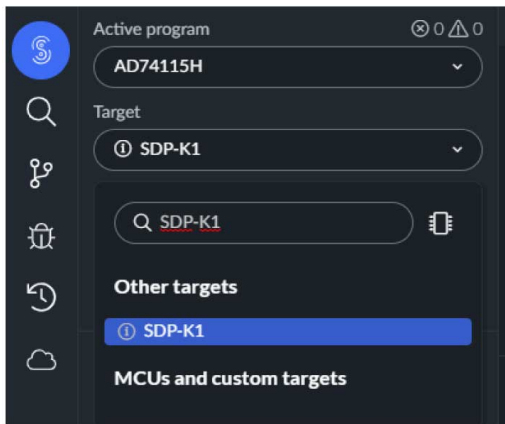

Figure 14. Choose SDP-K1 Platform

4. Wait until the libraries are imported (see [Figure 15](#)).

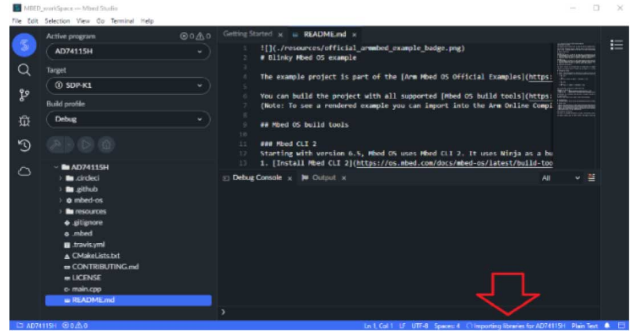

Figure 15. Wait Until Project Libraries Import

5. Remove the **main.cpp** file from the project.
6. Download **AD74115H_noOs_Drivers** files from [AD74115H](#) product page.
7. Copy paste all AD74115H driver files to your project folder.
8. Compile your project (see [Figure 16](#)).

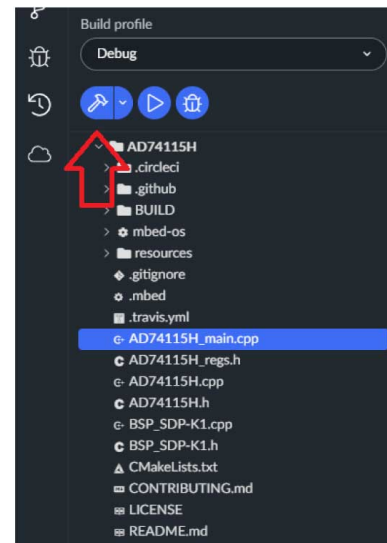

Figure 16. Compile MBED Project

9. Connect the SDP-K1 board to the EVAL-AD74115H-ARDZ.
10. Connect a USB cable to the PC and then to the SDP-K1 board.
11. Power up the EVAL-AD74115H-ARDZ with the relevant power supplies.
12. Download the code to the SDP-K1 board (see [Figure 17](#)).

NO-OS DRIVER QUICK START PROCEDURES

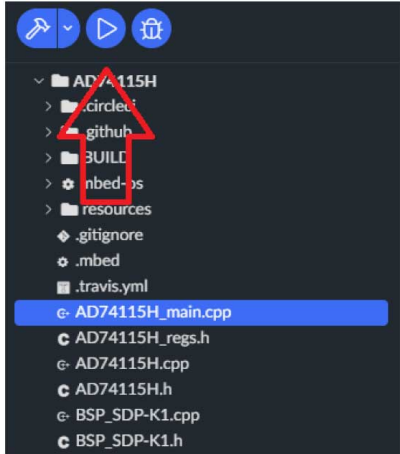
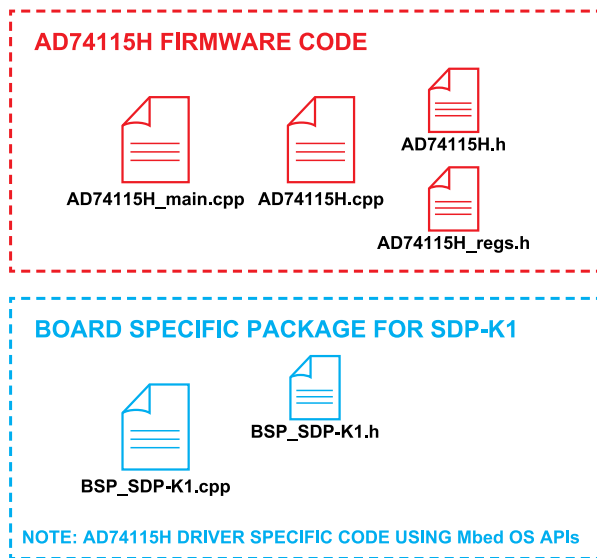

Figure 17. Download the Code to the SDP-K1 Board

Analog Devices has written permission to use these screenshots from Arm Limited. For further information on Arm, visit the Arm Limited website.

AD74115H Mbed No-OS Driver Structure

The AD74115H No-OS driver consists of several files divided into the following two groups:



- ▶ The AD74115H firmware code, which includes the following:
 - ▶ Portable part specific C firmware, these files include all functions concerning control, configuration, or setup of the AD74115H. (Note that Mbed Studio is using a C++ (.cpp) extension. However, the code was written in C to be easily compatible to user desired microcontrollers.)
 - ▶ The **AD74115H_main.cpp**, **AD74115H_regs.h**, **AD74115.cpp**, and **AD74115.h** files are included.
- ▶ Board specific package for the **SDP-K1**, which includes the following:
 - ▶ Platform specific SDP-K1 driver, these files control the SDP-K1 board, which communicates with the AD74115H via the SPI. These files are using Mbed OS. (Note that, once the SDP-K1 platform change is made to the user defined platform or microcontroller, users must modify these functions accordingly.)
 - ▶ The **BSP_SDP-K1.cpp** and **BSP_SDP-K1.h** files are included.

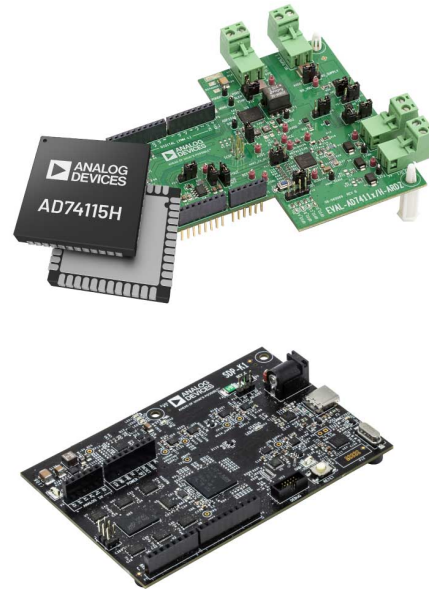

Figure 18. AD74115H No-OS Firmware Structure

NO-OS DRIVER QUICK START PROCEDURES

SPI SETUP USING USER DEFINED MICROCONTROLLER

Once a different platform other than the SDP-K1 is used, power up the digital input side of the ADP1034 by 3.3 V.

It is possible for users to control the AD74115H by using a user defined microcontroller. The SPI is provided via the Arduino-compatible shield pins. The Arduino connector pins, which are important for proper function, are encircled in red in Figure 19. The RESET pin must be controlled by the general-purpose input and output (GPIO) or be tied to the high level. Otherwise, the EVAL-AD74115H-ARDZ is held in a reset state.

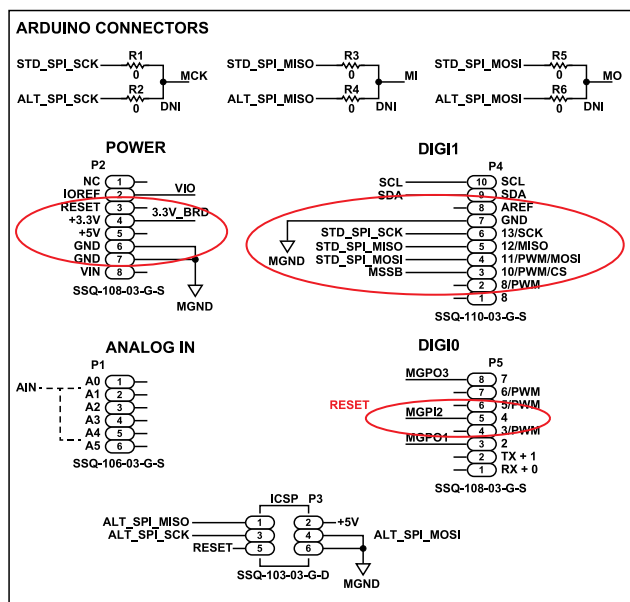

Figure 19. Arduino Connector During User-Defined SPI Setup

EVALUATION BOARD SCHEMATICS AND ARTWORK

120

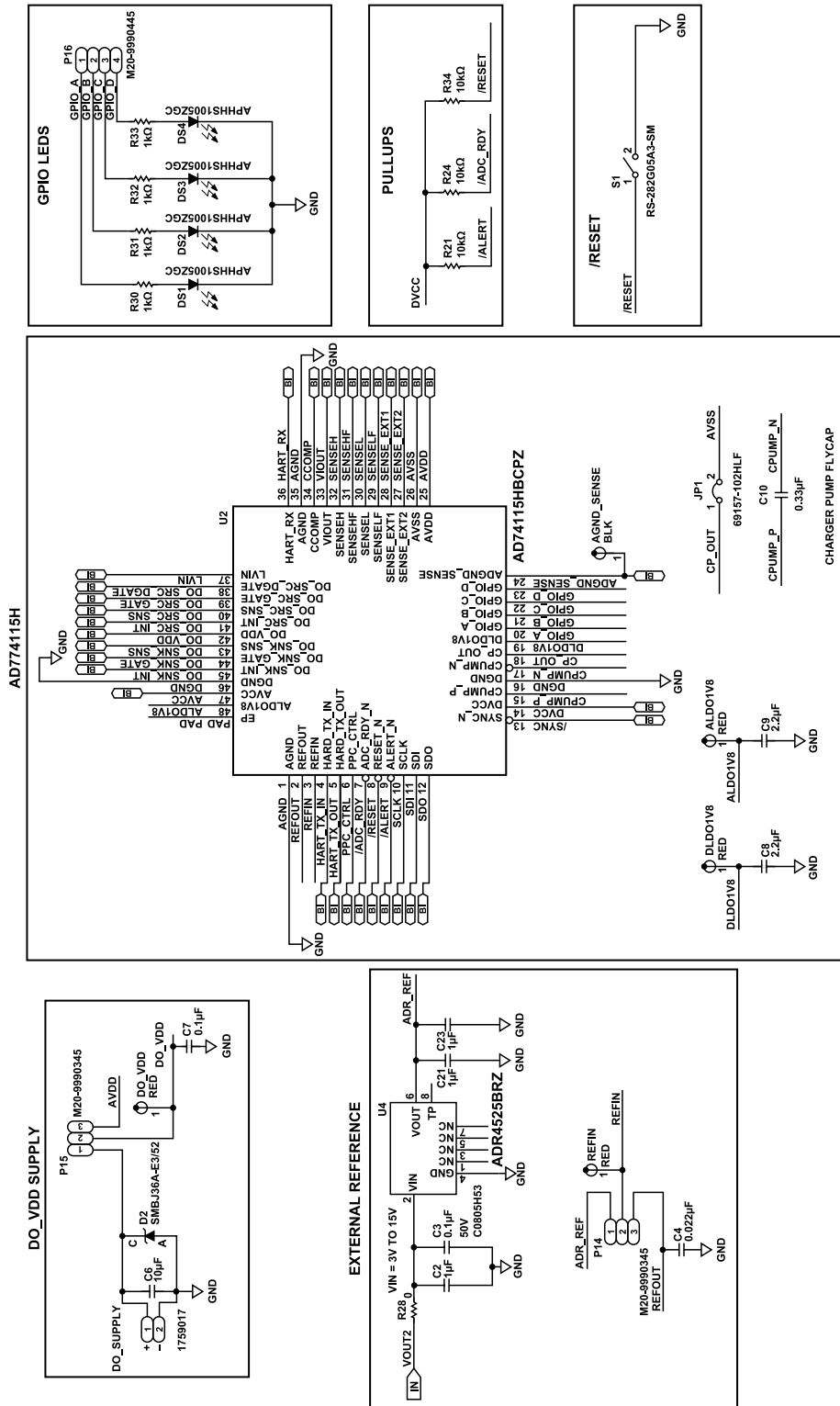

Figure 21. AD74115H with Optional Digital Output Supply, External Reference and GPIO Connections

EVALUATION BOARD SCHEMATICS AND ARTWORK

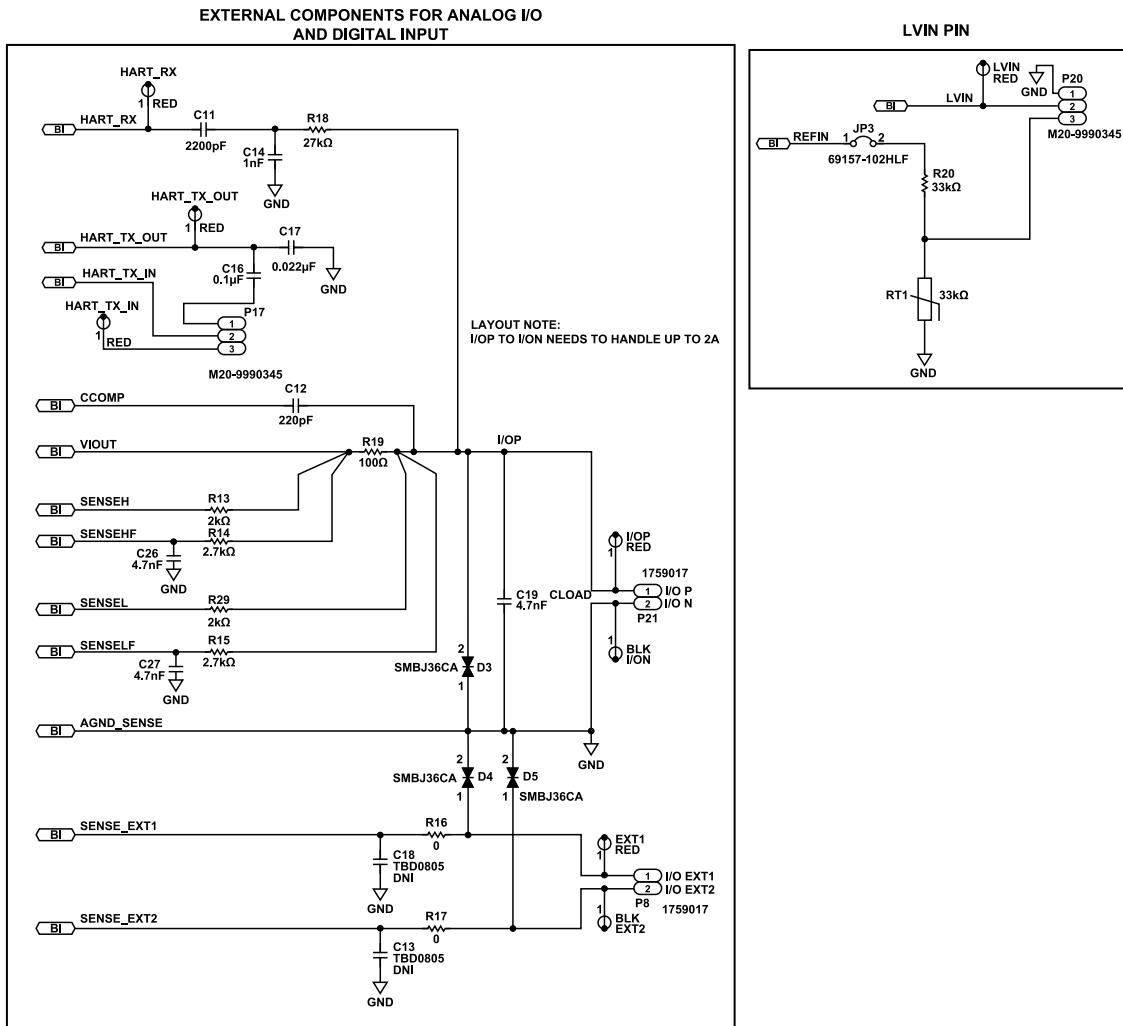

Figure 22. Channel Input and Output Circuitry Including Screw Terminals and LVIN Connections

EVALUATION BOARD SCHEMATICS AND ARTWORK

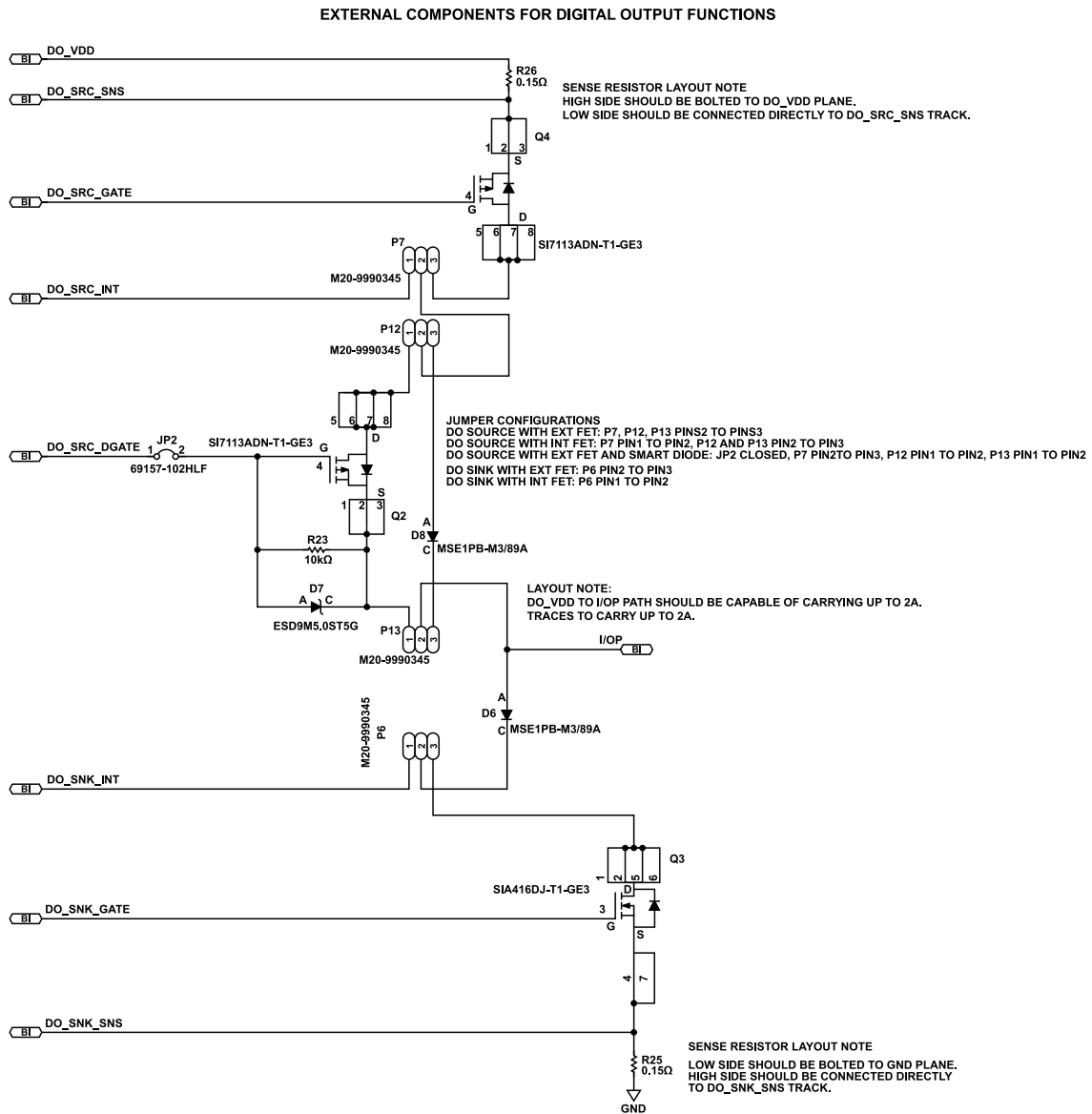

Figure 23. Digital Output Circuitry

EVALUATION BOARD SCHEMATICS AND ARTWORK

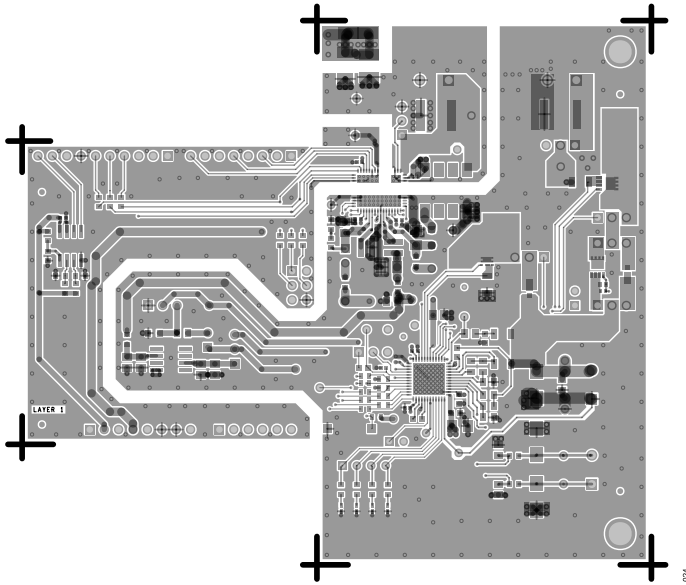

Figure 24. Layer 1, Top Layer

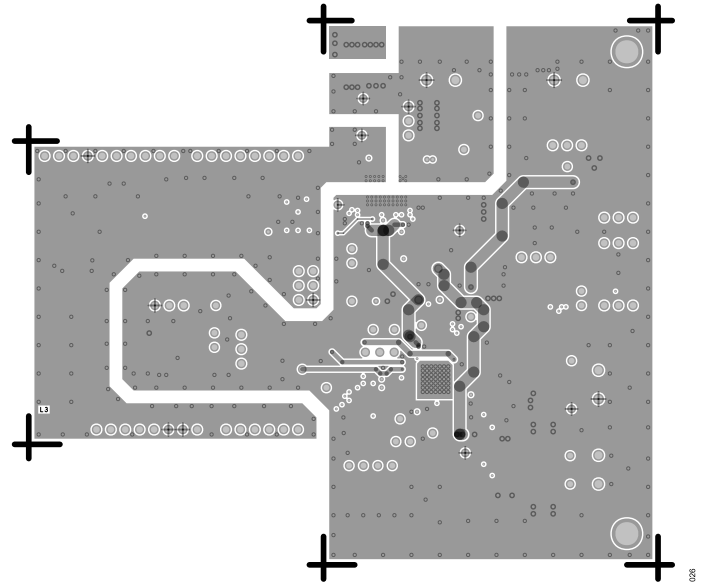

Figure 26. Layer 3, Power Layer

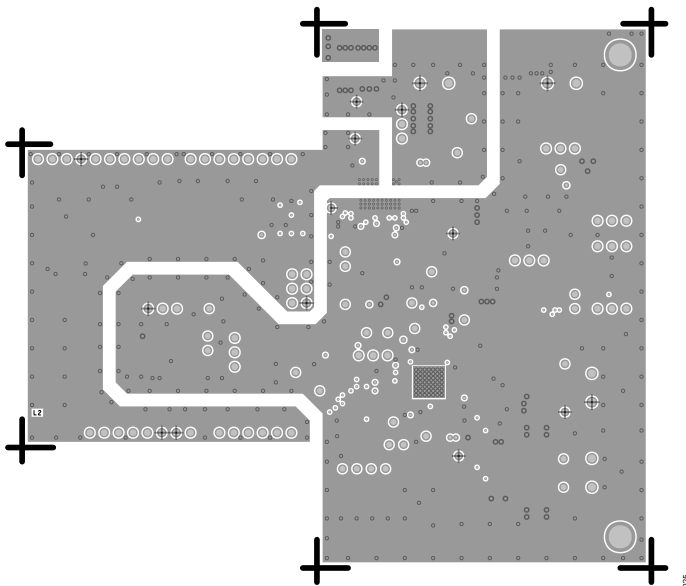

Figure 25. Layer 2, Ground Layer

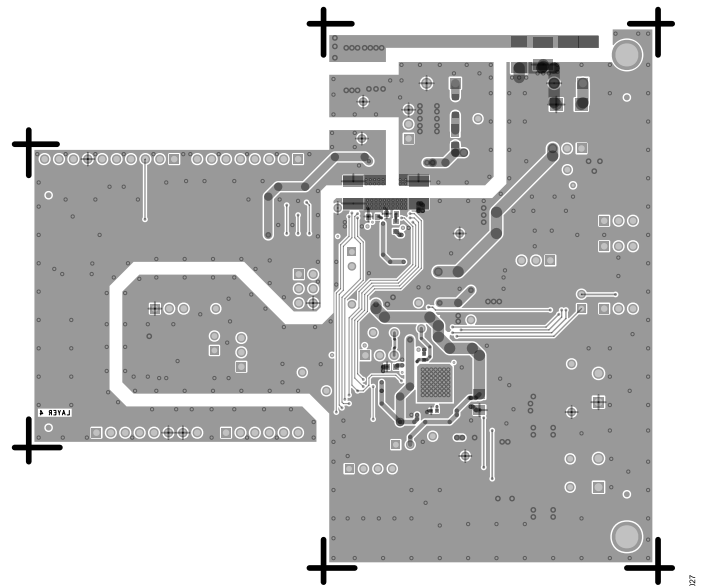

Figure 27. Layer 4, Bottom Layer

ORDERING INFORMATION

BILL OF MATERIALS

Table 3. Bill of Materials

Quantity	Reference Designator	Description	Manufacturer	Part Number
7	AGND_SENS E, EXT2, I/ON, MGND, PGNDP, SGND1, SGND2	Connector, printed circuit board (PCB), black test points	Vero Technologies	20-2137
17	ALDO1V8, AVCC, AVDD, AVSS, DLDO1V8, DO_VDD, DVCC, EXT1, HART_RX, HART_TX_IN, HART_TX_OUT, I/OP, LVIN, PPC_CTRL, REFIN, SWP, VINP	Connector, PCB, red test points	Vero Technologies	20-313137
1	C1	0.1 μ F ceramic capacitor, 16 V, 10%, X7R, 0402, AEC-Q200	Murata	GCM155R71C104KA55D
1	C10	0.33 μ F ceramic capacitor, 16 V, 20%, X7R, 0603	Samsung	CL10B334K08NNNC
1	C11	2200 pF capacitor, film, 63 V, 10%, 0805	Rubycon Corporation	63MU222KZ12012
1	C12	220 pF ceramic capacitor, 50 V, 5%, C0G, 0603	Yageo	CC0603JRNPO9BN221
1	C14	1 nF ceramic capacitor, 100 V, 10%, X7R, 0603	AVX Corporation	06031C102KAT2A
1	C16	0.1 μ F ceramic capacitor, 16 V, 5%, X7R, 0603	Kemet	C0603C104J4RACTU
1	C17	0.022 μ F ceramic capacitor, 25 V, 10%, X7R, 0402	Samsung	CL05B223KA5NNNC
3	C19, C26, C27	4.7 nF ceramic capacitors, 100 V, 10%, X7R, 0805	Würth Elektronik	8.85012E+11
3	C2, C21, C23	1 μ F ceramic capacitors, 25 V, 10%, X7R, 0805, AEC-Q200	Murata	GCM21BR71E105KA56L
4	C20, C25, C28, C40	3300 pF ceramic capacitors, 3000 V, 10%, X7R, 1812	Vishay	HV1812Y332KXHATHV
1	C22	4.7 μ F ceramic capacitor, 100 V, 10%, X7R, 2220	TDK	C5750X7R2A475K230KA
5	C24, C29, C30, C38, C39	0.1 μ F ceramic capacitors, 16 V, 10%, X7R, 0402	Kemet	C0402C104K4RACTU
1	C3	0.1 μ F ceramic capacitor, 50 V, 10%, X7R, 0805, AEC-Q200	AVX Corporation	08055C104K4T4A
1	C33	4.7 μ F ceramic capacitor, 50 V, 10%, X7R, 0805	Murata	GRM21BZ71H475KE15L
2	C34, C35	10 μ F ceramic capacitors, 50 V, 10%, X7R, 1206	Samsung	CL31B106KBHNNNE
2	C36, C37	0.1 μ F ceramic capacitors, 50 V, 10%, X7R, 0603	AVX Corporation	06035C104KAT2A
1	C4	0.022 μ F ceramic capacitor, 16 V, 10%, X7R, 0603	AVX Corporation	0603YC223KAT2A
1	C5	10 μ F ceramic capacitor, 16 V, 10%, X7R, 0805	Samsung	CL21B106KQNNNE
1	C6	10 μ F ceramic capacitor, 100 V, 20%, X7S, 2220, not recommended for new design (NRND)	TDK	C5750X7S2A106M230KB
1	C7	0.1 μ F ceramic capacitor, 100 V, 10%, X7R, 0805	TDK	C2012X7R2A104K125AA
2	C8, C9	2.2 μ F ceramic capacitors, 6.3 V, 20%, X5R, 0402, low effective series resistance (ESR), NRND	TDK	C1005X5R0J225M050BC
1	D1	Diode ultrafast rectifier, 1 A, 200 V, automotive	Diodes, Inc.	US1DWF-7
1	D10	Diode, zener, voltage regulator, 47 V, 0.5 W	On Semiconductor	MMSZ5261BT1G
1	D11	Diode, Schottky, barrier rectifier, 1 A, 200 V	Diodes, Inc.	DFLS1200Q-7
1	D2	Diode, TVS, single unidirectional, 36 V, 600 W	Vishay	SMBJ36A-E3/52

ORDERING INFORMATION

Table 3. Bill of Materials

Quantity	Reference Designator	Description	Manufacturer	Part Number
3	D3, D4, D5	Diodes, TVS, bidirectional	Fairchild Semiconductor	SMBJ36CA
2	D6, D8	Diodes, electrostatic discharge (ESD), capability rectifier, 1 A	Vishay	MSE1PB-M3/89A
1	D7	Diode, TVS unidirectional	On Semiconductor	ESD9M5.0ST5G
4	DO_SUPPLY, P8, P18, P21	Connector PCB, two position, headers	Phoenix Contact	1759017
4	DS1, DS2, DS3, DS4	Light emitting diodes (LEDs) green, surface-mount devices (SMD)	Kingbright	APHHS1005ZGC
4	JP1, JP2, JP3, JP8	Connector, PCB, Berg, jumpers, male, two position, 1X, M000385	Amphenol, FCI	69157-102HLF
2	L1, L2	Inductors, shield power, 0.39 A, 3 Ω dc resistance	Coilcraft, Inc.	XFL3012-104MEB
1	P1	Connector, PCB, receptacle, 25 mil, square post, 2.54 mm pitch	Samtec	SSQ-106-03-G-S
9	P6, P7, P12, P13, P14, P15, P17, P19, P20	Connector, PCB, headers, 2.54 mm pitch, single in-line, vertical PC tail	Harwin	M20-9990345
1	P16	Connector, PCB, vertical PC tail pin header	Harwin	M20-9990445
2	P2, P5	Connectors, PCB, receptacle, 25 mil, square post, 2.54 mm pitch	Samtec	SSQ-108-03-G-S
1	P3	Connector, PCB, receptacle, 25 mil, square post, dual row, 2.54 mm pitch	Samtec	SSQ-103-03-G-D
1	P4	Connector, PCB, receptacle, 25 mil, square post, 2.54 mm pitch	Samtec	SSQ-110-03-G-S
2	Q2, Q4	Transistors, P-channel MOSFET, 100 V, 10.8 A	Vishay	SI7113ADN-T1-GE3
1	Q3	Transistor, N-channel MOSFET, 100 V, 11.3 A	Vishay	SIA416DJ-T1-GE3
16	R1, R3, R5, R16, R17, R28, R35, R36, R37, R38, R39, R40, R41, R47, R48, R49	0 Ω resistors, jumper, 1/10 W, 0603, AEC-Q200	Panasonic	ERJ-3GEY0R00V
3	R8, R9, R12	100 k Ω resistors, SMD, 1%, 1/16 W, 0603	Multicomp (SPC)	MC 0.063W 0603 1% 100K
1	R13	2 k Ω resistor, SMD, 0.01%, 1/8 W, 0805, AEC-Q200	Stackpole Electronics, Inc.	RNCF0805TKY2K00
2	R14, R15	2.7 k Ω resistors, SMD, 0.5%, 1/4 W, 0805, AEC-Q200	Panasonic	ERJ-PB6D2701V
1	R18	27 k Ω resistor, SMD, 1%, 1/8 W, 1206	Multicomp (SPC)	MC 0.125W 1206 1% 27K.
1	R19	100 Ω resistor, SMD, 0.05%, 1/4 W, 1206, AEC-Q200	SUSUMU CO, LTD	RG3216N-1000-W-T1
1	R20	33 k Ω resistor, SMD, 0.1%, 1/8 W, 0805, AEC-Q200, high reliability	Panasonic	ERA-6AEB333V
3	R21, R24, R34	10 k Ω resistors, SMD, 1%, 1/10 W, 0603, AEC-Q200	Panasonic	ERJ-3EKF1002V
1	R23	10 k Ω resistor, SMD, 1%, 1/16 W, 0402, AEC-Q200	Vishay	CRCW040210K0FKED
2	R25, R26	0.15 Ω resistors, SMD, 1%, 1/4 W, 1206	BOURNS	CRL1206-FW-R150ELF
1	R29	2 k Ω resistor, SMD, 1%, 1/8 W, 0805, AEC-Q200	Panasonic	ERJ-6ENF2001V
4	R30, R31, R32, R33	1 k Ω resistors, SMD, 1%, 1/10 W, 0603, AEC-Q200	Panasonic	ERJ-3EKF1001V
1	R42	3.48 M Ω resistor, SMD, 1%, 1/10 W, 0603, AEC-Q200	Vishay	CRCW06033M48FKEA
1	R43	118 k Ω resistor, SMD, 1%, 1/10 W, 0603, AEC-Q200	Panasonic	ERJ-3EKF1183V
1	R44	100 k Ω resistor, SMD, 1%, 1/10 W, 0603, AEC-Q200	Panasonic	ERJ-3EKF1003V
1	R45	191 k Ω resistor, SMD, 1%, 1/10 W, 0603, AEC-Q200	Vishay	CRCW0603191KFKEA
1	R46	3.4 M Ω resistor, SMD, 1%, 1/10 W, 0603, AEC-Q200	Vishay	CRCW06033M40FKEA
1	RT1	33 k Ω thermistor, negative temperature coefficient, 5%, 0805, AEC-Q200	Vishay	NTCS0805E3333JHT
1	S1	Tactile switch, single-pole, single throw normally open, 0.05 A, 12 V	C&K	RS-282G05A3-SM RT
1	T1	Transformer flyback low leakage, 4.5 V to 6 V input	Coilcraft, Inc.	ZA9644-AED
1	U1	IC 32 KBIT serial EEPROM	Microchip Technology	24AA32A-I/SN

ORDERING INFORMATION

Table 3. Bill of Materials

Quantity	Reference Designator	Description	Manufacturer	Part Number
1	U2	Single-channel, software configurable input and output with HART modem	Analog Devices	AD74115HBCPZ
1	U3	3-channel isolated micropower management unit with seven digital isolators and programmable power control	Analog Devices	ADP1034ACP0Z-1-R7
1	U4	Ultralow noise, high accuracy 2.5 V voltage reference	Analog Devices	ADR4525BRZ
13	Not applicable	Jumpers, open top, 2.54 mm center, black	Sullins	QPC02SXGN-RC
2	Not applicable	Board support snap lock screw mount ¼ inch, nylon	Essentra	TCBS-12-01
4	Not applicable	Plugs, terminal block, two position, 5.08 mm	Phoenix Contact	1757019
2	C13, C18	Capacitors, C0805, do not integrate (DNI)	Not applicable	Not applicable
2	C31, C32	10 µF ceramic capacitors, 50 V, 10%, X7R, 1206, DNI	Samsung	CL31B106KBHNNNE
6	R2, R4, R6, R7, R10, R11	0 Ω resistors, SMD, jumper, 1/10 W, 0603, AEC-Q200, DNI	Panasonic	ERJ-3GEY0R00V
2	R27, R50	4.7 MΩ resistors, SMD, 5%, 1/2 W, 2010, high voltage, DNI	Bourns	CHV2010-JW-475ELF
4	TP1, TP2, TP3, TP4	Connector, PCB, test points, DNI	Harwin	S1751-46

ORDERING INFORMATION**NOTES****ESD Caution**

ESD (electrostatic discharge) sensitive device. Charged devices and circuit boards can discharge without detection. Although this product features patented or proprietary protection circuitry, damage may occur on devices subjected to high energy ESD. Therefore, proper ESD precautions should be taken to avoid performance degradation or loss of functionality.

Legal Terms and Conditions

By using the evaluation board discussed herein (together with any tools, components documentation or support materials, the "Evaluation Board"), you are agreeing to be bound by the terms and conditions set forth below ("Agreement") unless you have purchased the Evaluation Board, in which case the Analog Devices Standard Terms and Conditions of Sale shall govern. Do not use the Evaluation Board until you have read and agreed to the Agreement. Your use of the Evaluation Board shall signify your acceptance of the Agreement. This Agreement is made by and between you ("Customer") and Analog Devices, Inc. ("ADI"), with its principal place of business at Subject to the terms and conditions of the Agreement, ADI hereby grants to Customer a free, limited, personal, temporary, non-exclusive, non-sublicensable, non-transferable license to use the Evaluation Board FOR EVALUATION PURPOSES ONLY. Customer understands and agrees that the Evaluation Board is provided for the sole and exclusive purpose referenced above, and agrees not to use the Evaluation Board for any other purpose. Furthermore, the license granted is expressly made subject to the following additional limitations: Customer shall not (i) rent, lease, display, sell, transfer, assign, sublicense, or distribute the Evaluation Board; and (ii) permit any Third Party to access the Evaluation Board. As used herein, the term "Third Party" includes any entity other than ADI, Customer, their employees, affiliates and in-house consultants. The Evaluation Board is NOT sold to Customer; all rights not expressly granted herein, including ownership of the Evaluation Board, are reserved by ADI. CONFIDENTIALITY. This Agreement and the Evaluation Board shall all be considered the confidential and proprietary information of ADI. Customer may not disclose or transfer any portion of the Evaluation Board to any other party for any reason. Upon discontinuation of use of the Evaluation Board or termination of this Agreement, Customer agrees to promptly return the Evaluation Board to ADI. ADDITIONAL RESTRICTIONS. Customer may not disassemble, decompile or reverse engineer chips on the Evaluation Board. Customer shall inform ADI of any occurred damages or any modifications or alterations it makes to the Evaluation Board, including but not limited to soldering or any other activity that affects the material content of the Evaluation Board. Modifications to the Evaluation Board must comply with applicable law, including but not limited to the RoHS Directive. TERMINATION. ADI may terminate this Agreement at any time upon giving written notice to Customer. Customer agrees to return to ADI the Evaluation Board at that time. LIMITATION OF LIABILITY. THE EVALUATION BOARD PROVIDED HEREUNDER IS PROVIDED "AS IS" AND ADI MAKES NO WARRANTIES OR REPRESENTATIONS OF ANY KIND WITH RESPECT TO IT. ADI SPECIFICALLY DISCLAIMS ANY REPRESENTATIONS, ENDORSEMENTS, GUARANTEES, OR WARRANTIES, EXPRESS OR IMPLIED, RELATED TO THE EVALUATION BOARD INCLUDING, BUT NOT LIMITED TO, THE IMPLIED WARRANTY OF MERCHANTABILITY, TITLE, FITNESS FOR A PARTICULAR PURPOSE OR NON-INFRINGEMENT OF INTELLECTUAL PROPERTY RIGHTS. IN NO EVENT WILL ADI AND ITS LICENSORS BE LIABLE FOR ANY INCIDENTAL, SPECIAL, INDIRECT, OR CONSEQUENTIAL DAMAGES RESULTING FROM CUSTOMER'S POSSESSION OR USE OF THE EVALUATION BOARD, INCLUDING BUT NOT LIMITED TO LOST PROFITS, DELAY COSTS, LABOR COSTS OR LOSS OF GOODWILL. ADI'S TOTAL LIABILITY FROM ANY AND ALL CAUSES SHALL BE LIMITED TO THE AMOUNT OF ONE HUNDRED US DOLLARS (\$100.00). EXPORT. Customer agrees that it will not directly or indirectly export the Evaluation Board to another country, and that it will comply with all applicable United States federal laws and regulations relating to exports. GOVERNING LAW. This Agreement shall be governed by and construed in accordance with the substantive laws of the Commonwealth of Massachusetts (excluding conflict of law rules). Any legal action regarding this Agreement will be heard in the state or federal courts having jurisdiction in Suffolk County, Massachusetts, and Customer hereby submits to the personal jurisdiction and venue of such courts. The United Nations Convention on Contracts for the International Sale of Goods shall not apply to this Agreement and is expressly disclaimed.

