

FINISH TYPE	"0" TIN	"1" 15MICROINCH GOLD	"2" 30MICROINCH GOLD				
CKT	HDR ASSY PN	HDR ASSY PN	HDR ASSY PN	A	B	C	D
2	2189890200	2189890201	2189890202	9.65	3.00	14.20	2.95
3	2189890300	2189890301	2189890302	12.65	6.00	17.20	2.95
4	2189890400	2189890401	2189890402	15.65	9.00	20.20	7.70
5	2189890500	2189890501	2189890502	18.65	12.00	23.20	10.70

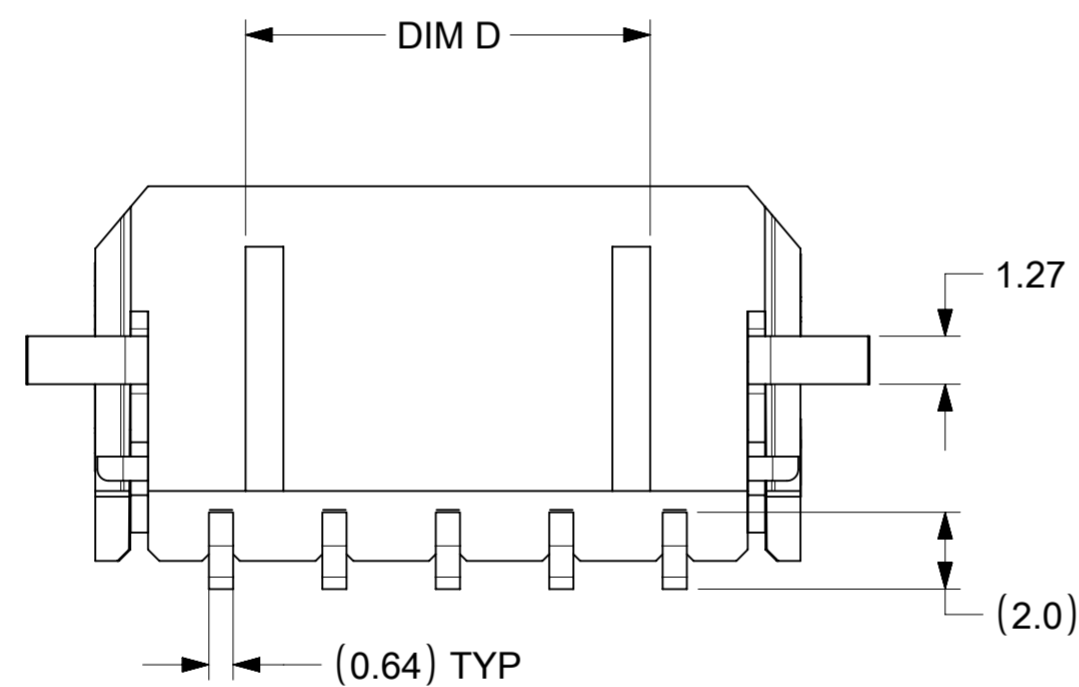
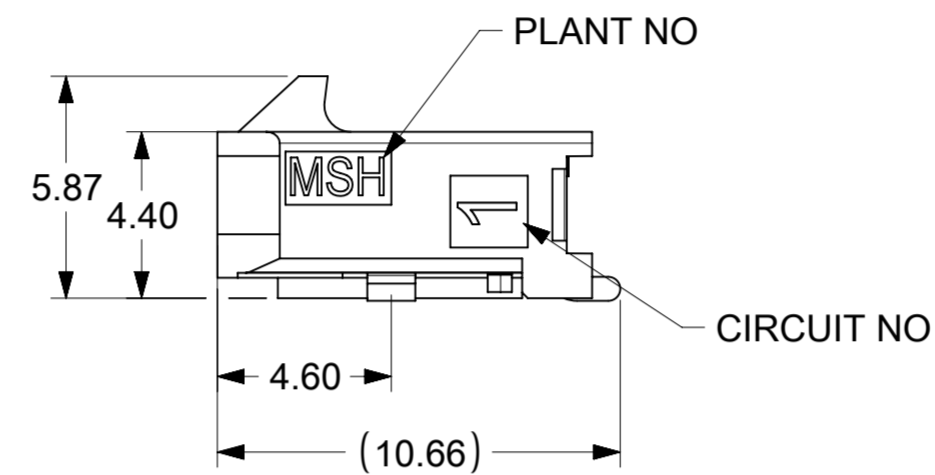
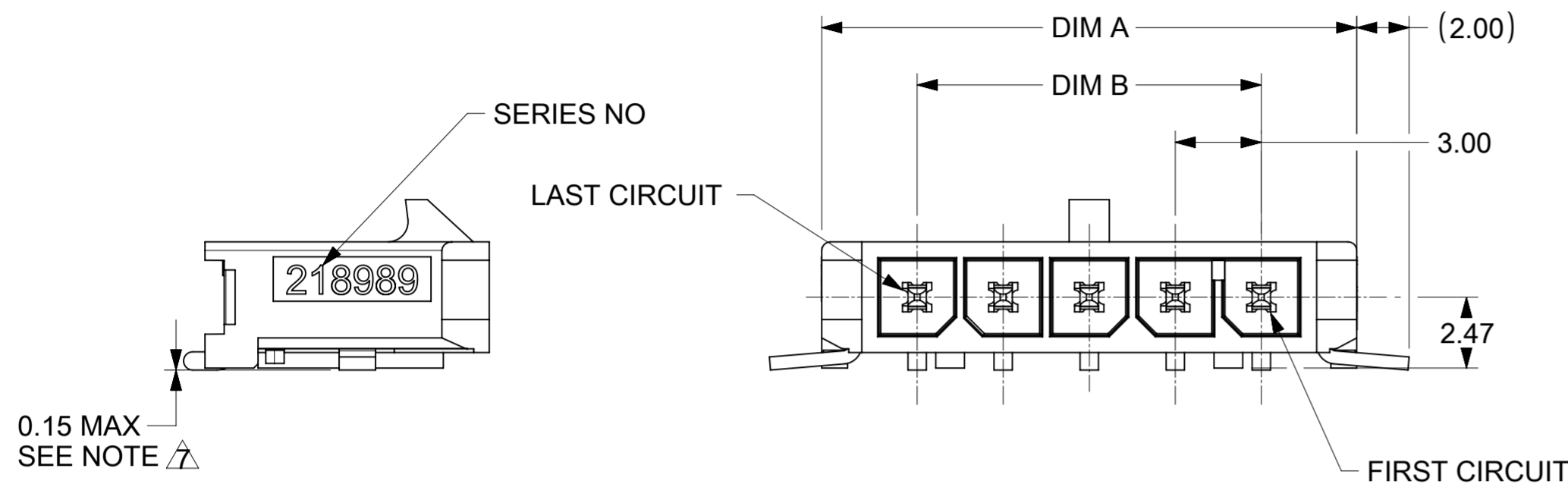

NOTES:

- HOSING MATERIAL: GLASS FILLED LIQUID CRYSTAL POLYMER, UL 94V-0, COLOR: BLACK  
TERMINAL MATERIAL: HIGH COPPER ALLOY
- FINISH:  
OPTION "0": REFLOW MATTE TIN OVER NICKEL  
OPTION "1": SELECT 15MICROINCH GOLD AND SELECT MATTE TIN OVER NICKEL.  
OPTION "2": SELECT 30MICROINCH GOLD AND SELECT MATTE TIN OVER NICKEL.
- PRODUCT SPECIFICATION : 2064600000-PS
- PRODUCT TEST SUMMARY: 2064600000-TS
- T&R PACK : 2189890001-PK
- MATE WITH RECEPTACLE 215759
- THE COPLANARITY DIMENSION IS ESTABLISHED BY PLACING THE ASSEMBLY ON A FLAT SURFACE. THE DISTANCE FROM THAT SURFACE TO THE BOTTOM OF ANY TERMINAL OR NAIL MUST NOT EXCEED 0.15
- THIS PART CONFORMS TO CLASS 'B' REQUIREMENTS OF COSMETIC SPECIFICATION PS-45499-002.
- METAL TAB MAY BE FLUSH WITH PCB. NO EXPOSED TRACES OR VIAS ALLOWED NEAR THESE AREAS.

LEGEND

218989 - \* \* \* \*

SERIES NO. \_\_\_\_\_

CKT NO. \_\_\_\_\_

OPTION  
0: RIGHT ANGLE WITH NAIL  
1: RIGHT ANGLE WITH CLIP  
2: VERTICAL WITH NAIL  
3: VERTICAL WITH CLIP

PLATING OPTION  
0: TIN  
1: 15MICROINCH AU  
2: 30MICROINCH AU

THIS DRAWING CONTAINS INFORMATION THAT IS PROPRIETARY TO MOLEX ELECTRONIC TECHNOLOGIES, LLC AND SHOULD NOT BE USED WITHOUT WRITTEN PERMISSION									
DIMENSION UNITS	SCALE	CURRENT REV DESC:				<b>molex</b>			
mm	NTS								
GENERAL TOLERANCES (UNLESS SPECIFIED)						MICRO-FIT + SINGLE ROW RIGHT ANGLE SMT HEADER WITH NAIL			
ANGULAR TOL	± 3.0°								
4 PLACES	±	EC NO: 724761			PRODUCT CUSTOMER DRAWING				
3 PLACES	±	DRWN: ZIXUAQ	2022/09/08						
2 PLACES	± 0.25	CHK'D: XQZHANG	2022/10/17		DOCUMENT NUMBER: 2189890000-SD DOC TYPE: PSD DOC PART: 000 REVISION: A				
1 PLACE	± 0.36	APPR: XQZHANG	2022/10/17						
0 PLACES	±	INITIAL REVISION:							
DRAFT WHERE APPLICABLE MUST REMAIN WITHIN DIMENSIONS		DRWN: ZIXUAQ	2022/09/08		MATERIAL NUMBER: SEE TABLE		CUSTOMER: GENERAL MARKET		SHEET NUMBER: 1 OF 2
THIRD ANGLE PROJECTION		DRAWING: A2-SIZE	SERIES: 218989						

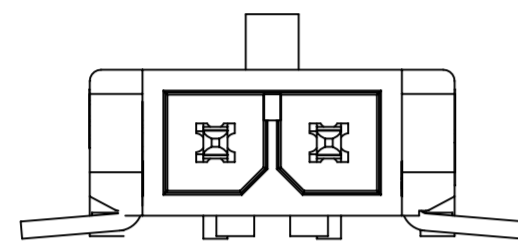

2CKT

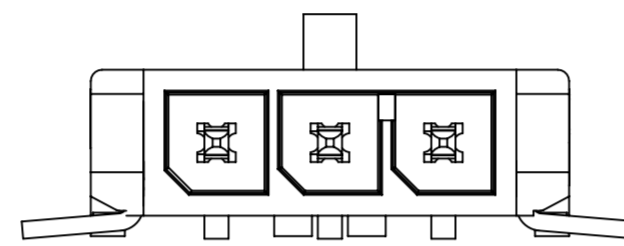

4CKT

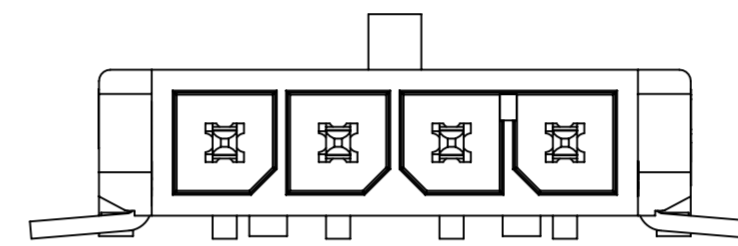

6CKT

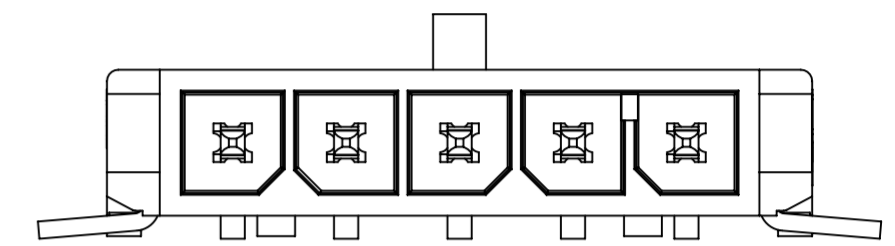

8CKT

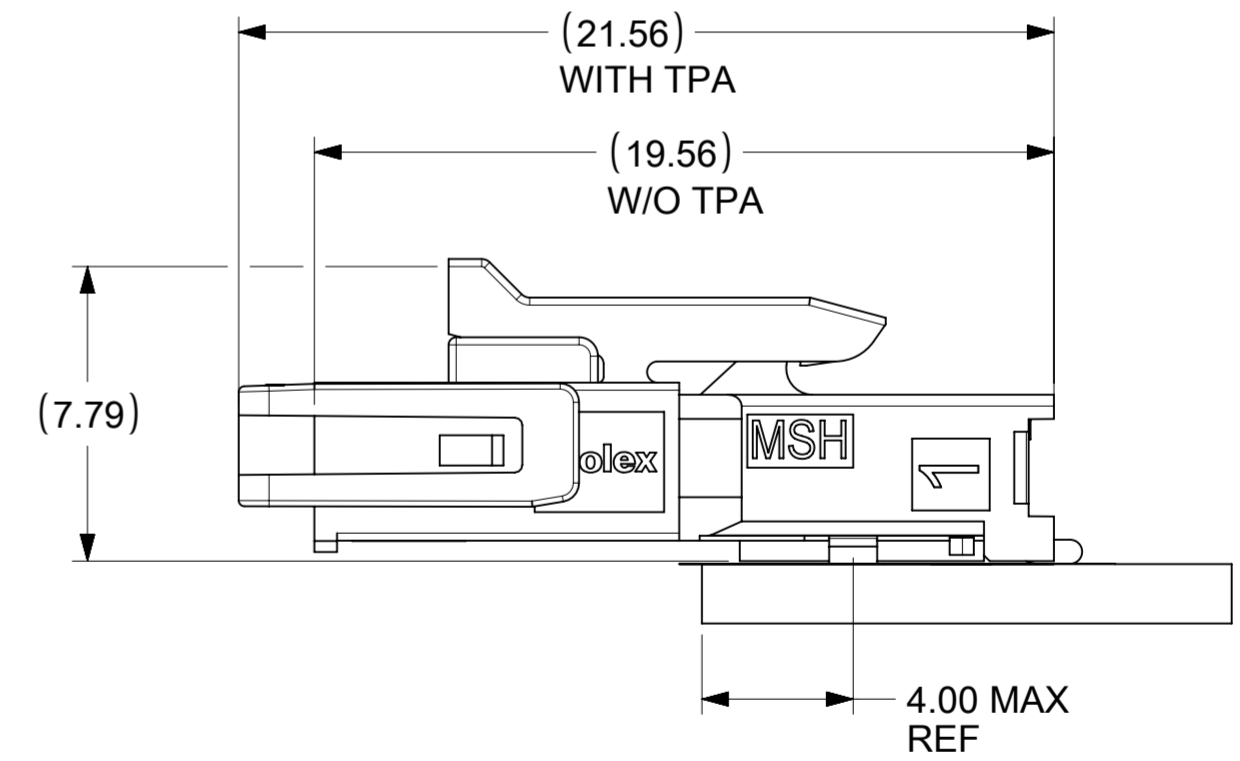
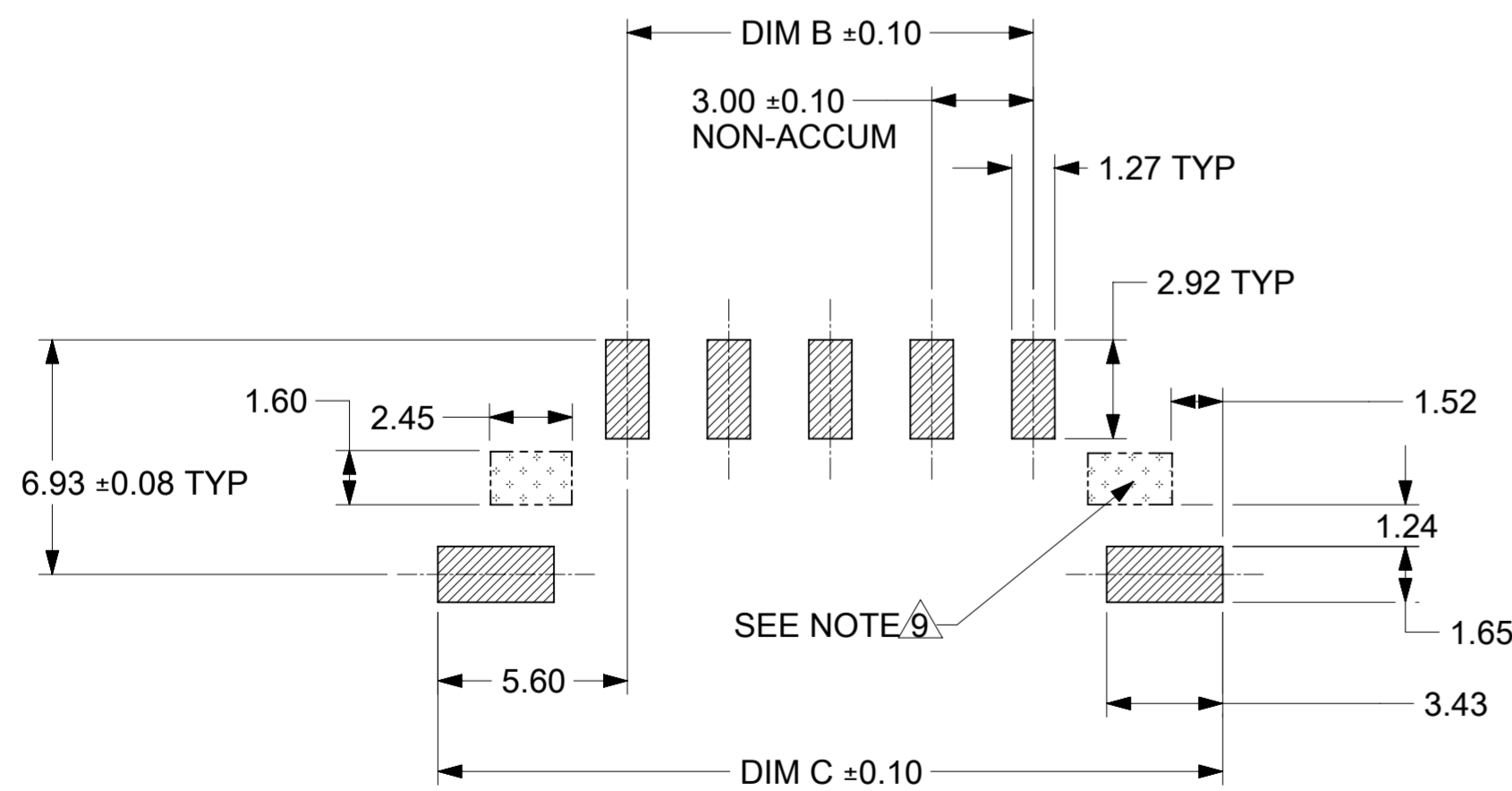

THIS DRAWING CONTAINS INFORMATION THAT IS PROPRIETARY TO MOLEX ELECTRONIC TECHNOLOGIES, LLC AND SHOULD NOT BE USED WITHOUT WRITTEN PERMISSION									
DIMENSION UNITS	SCALE	CURRENT REV DESC:							
mm	NTS								
GENERAL TOLERANCES (UNLESS SPECIFIED)					MICRO-FIT + SINGLE ROW RIGHT ANGLE SMT HEADER WITH NAIL  PRODUCT CUSTOMER DRAWING				
ANGULAR TOL	±	3.0°	EC NO: 724761						
4 PLACES	±		DRWN: ZIXUAQ	2022/09/08	DOCUMENT NUMBER: 2189890000-SD DOC TYPE: PSD DOC PART: 000 REVISION: A				
3 PLACES	±		CHK'D: XQZHANG	2022/10/17					
2 PLACES	±	0.25	APPR: XQZHANG	2022/10/17	MATERIAL NUMBER: SEE TABLE CUSTOMER: GENERAL MARKET SHEET NUMBER: 2 OF 2				
1 PLACE	±	0.36	INITIAL REVISION:						
0 PLACES	±		DRWN: ZIXUAQ	2022/09/08					
DRAFT WHERE APPLICABLE MUST REMAIN WITHIN DIMENSIONS		THIRD ANGLE PROJECTION		DRAWING	SERIES				
				A2-SIZE	218989				

DOCUMENT STATUS	P1	RELEASE DATE	2022/10/17	06:34:12
-----------------	----	--------------	------------	----------