



## Unidirectional TVSarray

### DESCRIPTION

This USB50403 – USB50424 Transient Voltage Suppressor (TVS) family is packaged in a SOT-143 configuration giving protection to 1 unidirectional data or interface line. It is designed for use in applications where protection is required at the board level from voltage transients caused by electrostatic discharge (ESD) as defined in IEC 61000-4-2, electrical fast transients (EFT) per IEC 61000-4-4, and effects of secondary effects of lightning. It is also available in RoHS compliant versions.

These TVS arrays have a peak power rating of 500 watts for an 8/20  $\mu$ sec pulse. This array is suitable for protection of sensitive circuitry consisting of TTL, CMOS, DRAM's, SRAM's, HCMOS, HSIC microprocessors, and Universal Serial Bus (USB) and I/O transceivers.

**Important:** For the latest information, visit our website <http://www.microsemi.com>.

### FEATURES

- Protects 1 unidirectional line.
- Surge protection per IEC 61000-4-2 and IEC 61000-4-4.
- Provides electrically isolated protection.
- UL 94V-0 flammability classification.
- Ultra low capacitance, 3 pF per line pair.
- Ultra low leakage.
- RoHS compliant versions available.

### APPLICATIONS / BENEFITS

- EIA-RS485 data rates: 5 Mbs
- 10 Base T Ethernet.
- USB data rate: 900 Mbs

### MAXIMUM RATINGS

Parameters/Test Conditions	Symbol	Value	Unit
Junction and Storage Temperature	$T_J$ and $T_{STG}$	-55 to +150	$^{\circ}C$
Peak Pulse Power @ 8/20 $\mu$ s (see <a href="#">Figure 1</a> )	$P_{PP}$	500	W
Impulse Repetition Rate	df	< 0.1	%
Capacitance (f = 1 MHz) @ 0 V	C	3	pF
Solder Temperature @ 10 s	$T_{SP}$	260	$^{\circ}C$

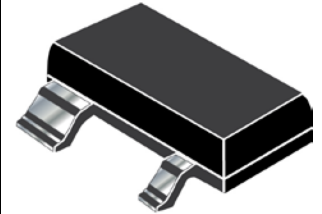

### SOT-143 Package

Also available in:

**Bidirectional SOT-143**  
(surface mount)

 [USB50403C – USB50424C](#)

#### MSC – Lawrence

6 Lake Street,  
Lawrence, MA 01841  
Tel: 1-800-446-1158 or  
(978) 620-2600  
Fax: (978) 689-0803

#### MSC – Ireland

Gort Road Business Park,  
Ennis, Co. Clare, Ireland  
Tel: +353 (0) 65 6840044  
Fax: +353 (0) 65 6822298

**Website:**

[www.microsemi.com](http://www.microsemi.com)

**MECHANICAL and PACKAGING**

- CASE: Molded SOT-143 surface mount.
- TERMINALS: Tin-lead or RoHS compliant annealed matte-tin plating.
- MARKING: See electrical characteristics table.
- POLARITY: Pin #1 defined by dot on top of package.
- TAPE & REEL option: Per EIA standard 481-1-A. Consult factory for quantities.
- WEIGHT: Approximately 0.035 grams.
- See [Package Dimensions](#) on last page.

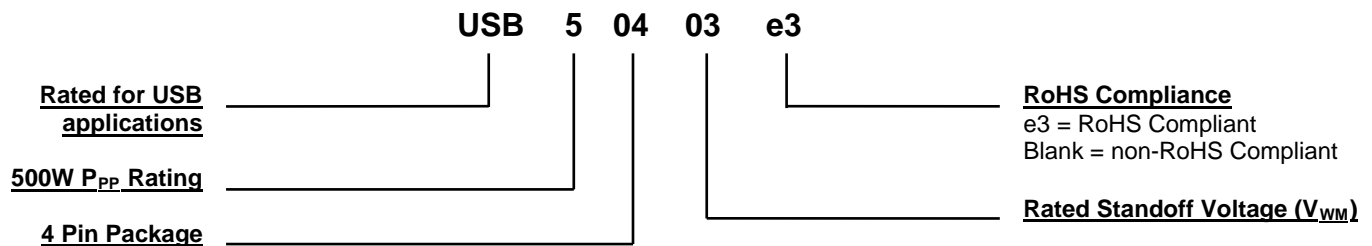
**PART NOMENCLATURE**

**SYMBOLS & DEFINITIONS**

Symbol	Definition
V <sub>WM</sub>	Stand Off Voltage: Maximum dc voltage that can be applied over the operating temperature range. V <sub>wm</sub> must be selected to be equal or be greater than the operating voltage of the line to be protected.
V <sub>(BR)</sub>	Minimum Breakdown Voltage: The minimum voltage the device will exhibit at a specified current.
V <sub>C</sub>	Clamping Voltage: Maximum clamping voltage across the TVS device when subjected to a given current at a pulse time of 20 μs.
I <sub>D</sub>	Standby Current: Leakage current at V <sub>WM</sub> .
C	Capacitance: Capacitance of the TVS as defined @ 0 volts at a frequency of 1 MHz and stated in picofarads.

**ELECTRICAL CHARACTERISTICS**

PART NUMBER	DEVICE MARKING*	STAND-OFF VOLTAGE	BREAKDOWN VOLTAGE	CLAMPING VOLTAGE	CLAMPING VOLTAGE	STANDBY CURRENT	CAPACITANCE	TEMPERATURE COEFFICIENT
		V <sub>WM</sub>	V <sub>(BR)</sub>	V <sub>C</sub>	V <sub>C</sub>	I <sub>D</sub>	(f= 1 MHz)	OF V <sub>(BR)</sub>
		Volts	@1 mA	@ 1 Amp	@ 5 Amp	@ V <sub>WM</sub>	@ 0 V	α <sub>VBR</sub>
		MAX	MIN	MAX	MAX	MAX	MAX	MAX
USB50403	AA	3.3	4	8	11	200	3	-5
USB50405	AB	5.0	6.0	10.8	13	20	3	1
USB50412	AC	12.0	13.3	19	26	1	3	8
USB50415	AD	15.0	16.7	24	32	1	3	11
USB50424	AE	24.0	26.7	43	57	1	3	28

\* Device marking has an e3 suffix added for the RoHS compliant option, e.g. AAe3, ABe3, ACe3, ADe3, and AEe3.

GRAPHS

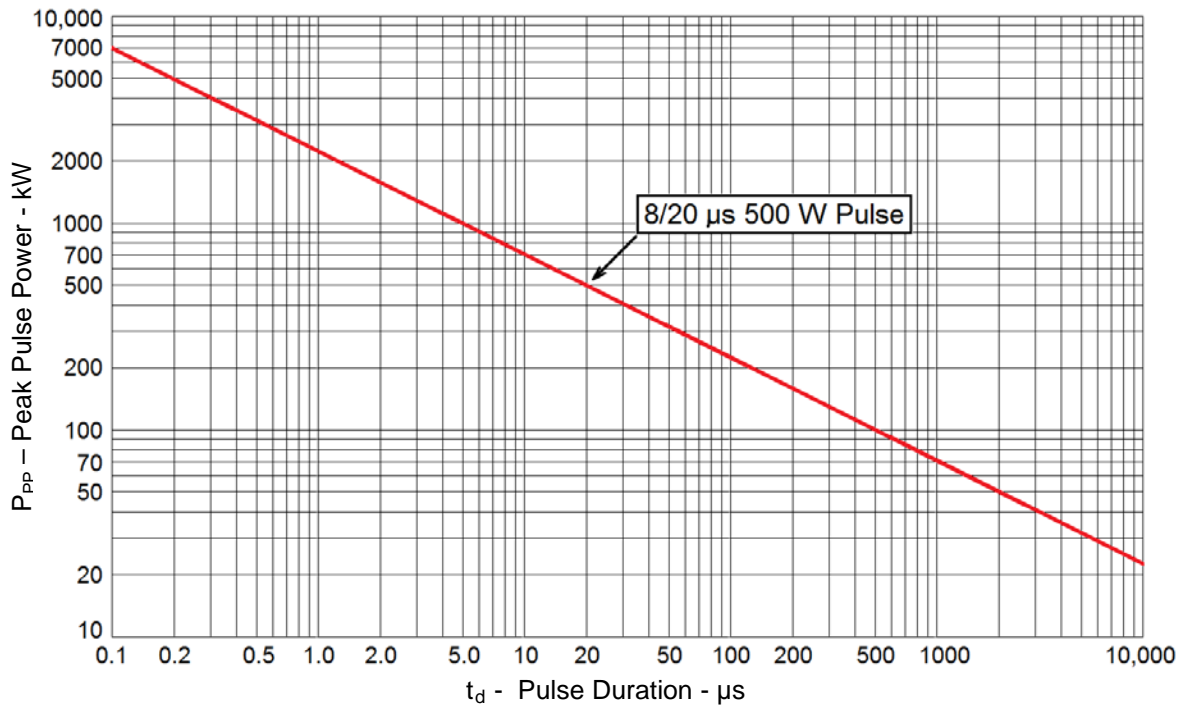

**FIGURE 1**  
Peak Pulse Power vs Pulse Time

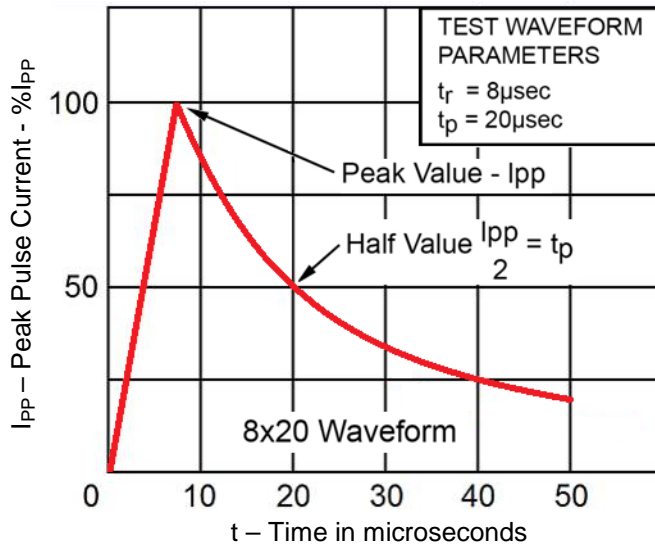

**FIGURE 2**  
Pulse Waveform

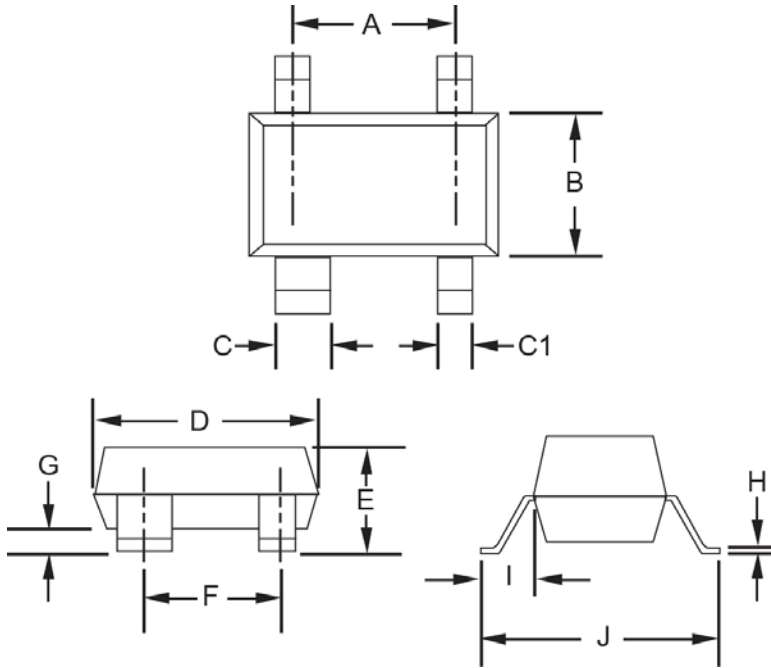
**PACKAGE DIMENSIONS**

Ltr	Dimensions			
	Inch		Millimeters	
	Min	Max	Min	Max
A	0.070	0.080	1.78	2.03
B	0.047	0.053	1.20	1.40
C	0.027	0.033	0.69	0.84
C1	0.012	0.018	0.30	0.46
D	0.107	0.113	2.72	2.87
E	0.042	0.045	1.07	1.14
F	0.067	0.079	1.70	2.01
G	0.002	0.008	0.051	0.20
H	0.003	0.009	0.076	0.23
I	0.018	0.023	0.46	0.58
J	0.083	0.093	2.11	2.36

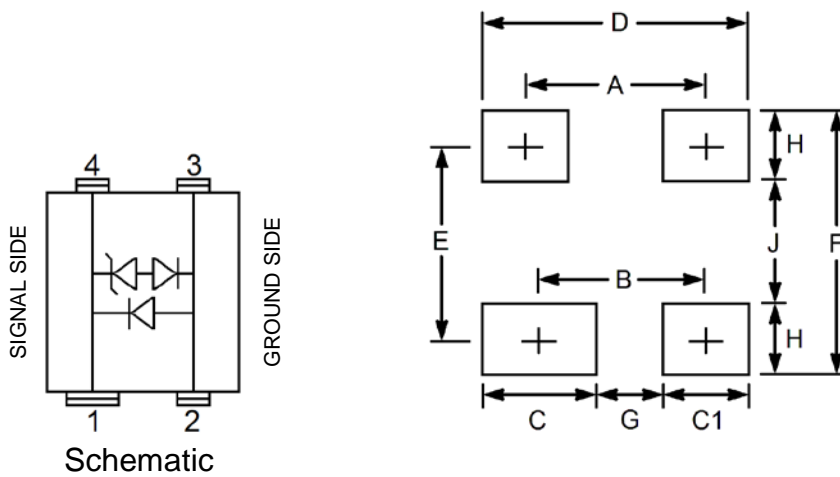
**PAD LAYOUT**

Ltr	Dimensions	
	Inch	Millimeters
	Typ	Typ
A	0.079	2.00
B	0.071	1.80
C	0.047	1.20
C1	0.033	0.85
D	0.112	2.85
E	0.075	1.90
F	0.108	2.75
G	0.310	0.80
H	0.033	0.85
J	0.041	1.05