

# PXE30-xxWSxx Single Output DC/DC Converters

10 to 40 Vdc or 18 to 75 Vdc input, 1.5 to 15 Vdc Single Output, 30W



## Features

- 30 WATTS MAXIMUM OUTPUT POWER
- OUTPUT CURRENT UP TO 8A
- STANDARD 2" X 1.6" X 0.4" PACKAGE
- HIGH EFFICIENCY UP TO 88%
- 4:1 WIDE INPUT VOLTAGE RANGE
- SIX-SIDED CONTINUOUS SHIELD
- FIXED SWITCHING FREQUENCY
- CE MARK MEETS 2006/95/EC, 93/68/EEC AND 2004/108/EC
- UL60950-1, EN60950-1 AND IEC60950-1 LICENSED
- ISO9001 CERTIFIED MANUFACTURING FACILITIES
- COMPLIANT TO RoHS EU DIRECTIVE 2002/95/EC

## Options

- Negative logic Remote On/Off

## APPLICATIONS

Wireless Network  
Telecom/Datacom  
Industry Control System  
Measurement  
Semiconductor Equipment

## General Description

The PXE30-xxWSxx series offers 30 watts of output power from a 2 x 1.6 x 0.4 inch package .It has a 4:1 wide input voltage of 10-40VDC or 18-75VDC and features 1600VDC of isolation, short-circuit and over-voltage protection.

## Table of Contents

Absolute Maximum Rating	P2	Heat Sink Consideration	P38
Output Specification	P2	Remote ON/OFF Control	P39
Input Specification	P3	Mechanical Data	P40
General Specification	P4	Recommended Pad Layout	P41
Characteristic Curves	P5	Output Voltage Adjustment	P42
Test Configurations	P33	Soldering and Reflow Consideration	P44
EMC Considerations	P34	Packaging Information	P44
Input Source Impedance	P36	Part Number Structure	P45
Output Over Current Protection	P36	Safety and Installation Instruction	P46
Output Over Voltage Protection	P37	MTBF and Reliability	P46
Short Circuit Protection	P37		
Thermal Consideration	P37		

Absolute Maximum Rating				
Parameter	Model	Min	Max	Unit
Input Voltage Continuous	24WSxx		40	Vdc
	48WSxx		75	
Transient (100ms)	24WSxx		50	
	48WSxx		100	
Input Voltage Variation (complies with EST300 132 part 4.4)	All		5	V/ms
Operating Ambient Temperature (with derating)	All	-40	85	°C
Operating Case Temperature	All		100	°C
Storage Temperature	All	-55	105	°C

Output Specification					
Parameter	Model	Min	Typ	Max	Unit
Output Voltage ( $V_{in} = V_{in(nom)}$ ; Full Load ; $T_A=25^\circ\text{C}$ )	xxWS1P5	1.485	1.5	1.515	Vdc
	xxWS1P8	1.782	1.8	1.818	
	xxWS2P5	2.475	2.5	2.525	
	xxWS3P3	3.267	3.3	3.333	
	xxWS05	4.95	5	5.05	
	xxWS12	11.88	12	12.12	
	xxWS15	14.85	15	15.15	
Voltage Adjustability	All	-10		+10	%
Output Regulation Line ( $V_{in}(\text{min})$ to $V_{in}(\text{max})$ at Full Load) Load (Min. to 100% of Full Load)	All	-0.5		+0.5	%
		-0.5		+0.5	
Output Ripple & Noise Peak-to-Peak (20MHz bandwidth) (Measured with a 0.1 $\mu\text{F}$ /50V MLCC)	xxWS1P5		60		mVp-p
	xxWS1P8		60		
	xxWS2P5		60		
	xxWS3P3		60		
	xxWS05		75		
	xxWS12		100		
	xxWS15		100		
Temperature Coefficient	All	-0.02		+0.02	%/°C
Output Voltage Overshoot ( $V_{in}(\text{min})$ to $V_{in}(\text{max})$ ; Full Load ; $T_A=25^\circ\text{C}$ )	All		0	5	% $V_b$
Dynamic Load Response ( $V_{in} = V_{in(nom)}$ ; $T_A=25^\circ\text{C}$ ) Load step change from 75% to 100% or 100 to 75% of Full Load Peak Deviation Setting Time ( $V_{OUT}$ -10% peak deviation)	All		250		mV
			250		$\mu\text{S}$
Output Current	xxWS1P5	0		8000	mA
	xxWS1P8	0		8000	
	xxWS2P5	0		8000	
	xxWS3P3	0		6000	
	xxWS05	0		6000	
	xxWS12	0		2500	
	xxWS15	0		2000	

Output Specification(Continued)					
Parameter	Model	Min	Typ	Max	Unit
Output Over Voltage Protection (Zener diode clamp)	xxWS1P5		3.9		Vdc
	xxWS1P8		3.9		
	xxWS2P5		3.9		
	xxWS3P3		3.9		
	xxWS05		6.2		
	xxWS12		15		
	xxWS15		18		
Output Over Current Protection	All			150	% FL.
Output Short Circuit Protection	All	Hiccup, automatic recovery			

Input Specification					
Parameter	Model	Min	Typ	Max	Unit
Operating Input Voltage	24WSxx	10	24	40	Vdc
	48WSxx	18	48	75	
Input Current (Maximum value at $V_{in} = V_{in(nom)}$ ; Full Load)	24WS1P5			658	mA
	24WS1P8			759	
	24WS2P5			1029	
	24WS3P3			994	
	24WS05			1506	
	24WS12			1506	
	24WS15			1488	
	48WS1P5			329	
	48WS1P8			380	
	48WS2P5			508	
	48WS3P3			497	
	48WS05			744	
	48WS12			753	
	48WS15			744	
	Input Standby Current (Typical value at $V_{in} = V_{in(nom)}$ ; No Load)	24WS1P5		35	
24WS1P8			35		
24WS2P5			40		
24WS3P3			50		
24WS05			65		
24WS12			65		
24WS15			70		
48WS1P5			20		
48WS1P8			20		
48WS2P5			25		
48WS3P3			30		
48WS05			30		
48WS12			35		
48WS15			45		
Under Voltage Lockout Turn-on Threshold		24WSxx			10
	48WSxx			18	

Input Specification(Continued)					
Parameter	Model	Min	Typ	Max	Unit
Under Voltage Lockout Turn-off Threshold	24WSxx 48WSxx		8 16		Vdc
Input Reflected Ripple Current (5 to 20MHz, 12 $\mu$ H Source Impedance)	All		20		mAp-p
Start Up Time (Vin = Vin(nom) and Constant Resistive Load) Power Up Remote ON/OFF	All		10 10		mS
Remote ON/OFF Control (The ON/OFF pin voltage is referenced to -VIN) Positive Logic DC-DC ON(Open) DC-DC OFF(Short) Negative Logic DC-DC ON(Short) DC-DC OFF(Open)	All	3 0 0 3		12 1.2 1.2 12	Vdc
Remote Off Input Current	All		3		mA
Input Current of Remote Control Pin	All	-0.5		0.5	mA

General Specification					
Parameter	Model	Min	Typ	Max	Unit
Efficiency (Vin = Vin(nom) ; Full Load ; TA=25°C)	24WS1P5 24WS1P8 24WS2P5 24WS3P3 24WS05 24WS12 24WS15 48WS1P5 48WS1P8 48WS2P5 48WS3P3 48WS05 48WS12 48WS15		80 83 85 87 87 87 88 80 83 86 87 88 87 88		%
Isolation Voltage Input to Output Input to Case, Output to Case	All	1600 1600			Vdc
Isolation Resistance	All	1			G $\Omega$
Isolation Capacitance	All			1000	pF
Switching Frequency	All		300		KHz
Weight	All		48		g
MTBF Bellcore TR-NWT-000332, TC=40°C MIL-HDBK-217F	All		1.315 $\times$ 10 <sup>6</sup> 3.456 $\times$ 10 <sup>5</sup>		hours
Over Temperature Protection	All		115		°C

Characteristic Curves

All test conditions are at 25°C. The figures are for PXE30-24WS1P5

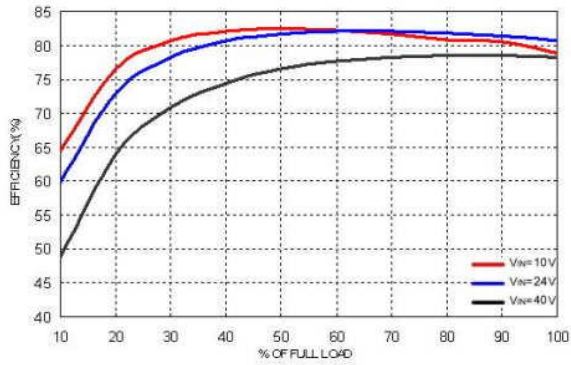

Efficiency Versus Output Current

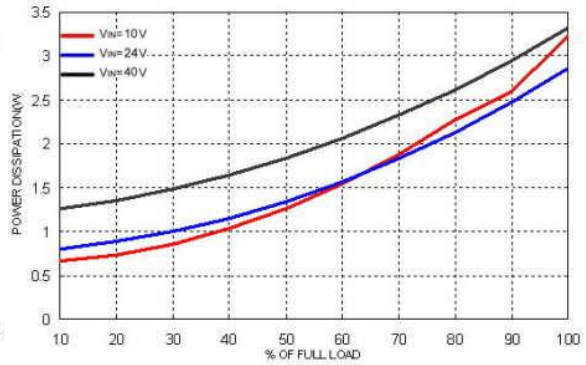

Power Dissipation Versus Output Current

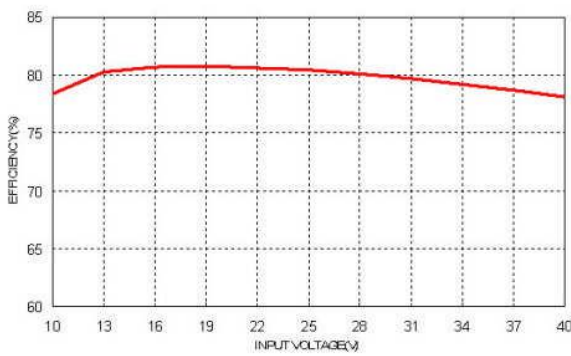

Efficiency Versus Input Voltage. Full Load

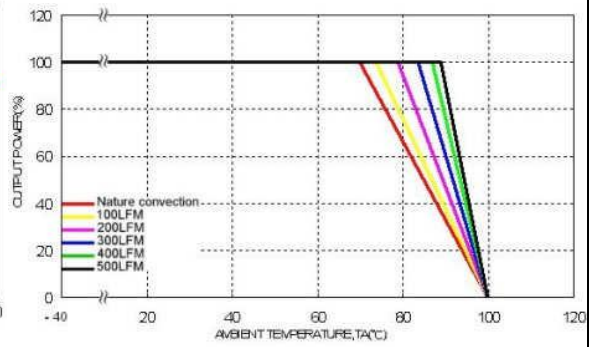

Derating Output Current Versus Ambient Temperature and Airflow Vin=Vin(nom)

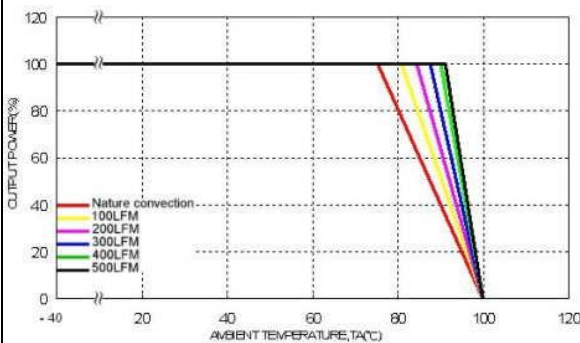

Derating Output Current Versus Ambient Temperature with Heat-Sink and Airflow, Vin = Vin(nom)

Characteristic Curves (Continued)

All test conditions are at 25°C. The figures are for PXE30-24WS1P5

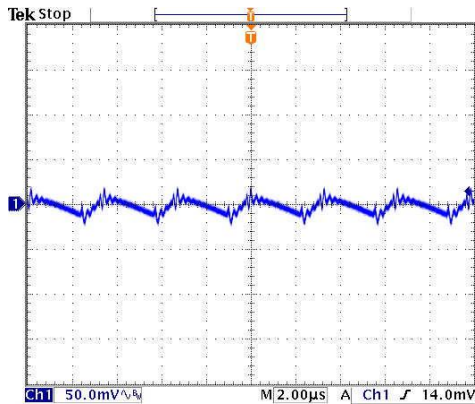

Typical Output Ripple and Noise.  
Vin=Vin(nom), Full Load

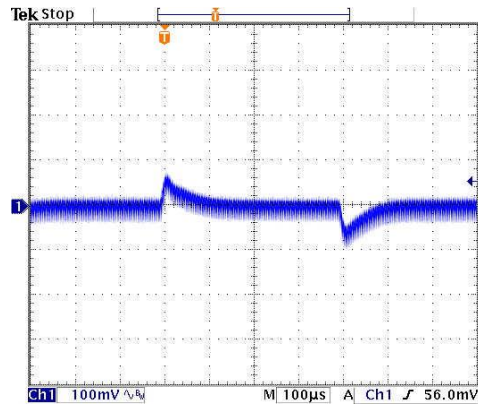

Transient Response to Dynamic Load Change from 100% to 75% to 100% of Full Load ; Vin=Vin(nom)

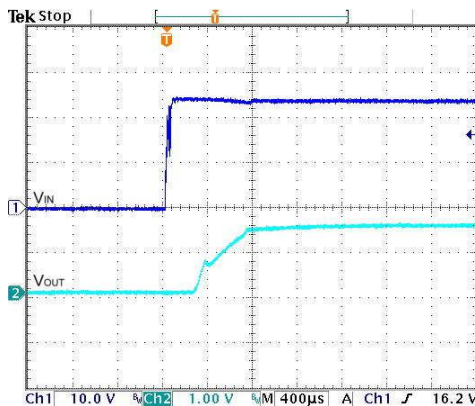

Typical Input Start-Up and Output Rise Characteristic  
Vin=Vin(nom), Full Load

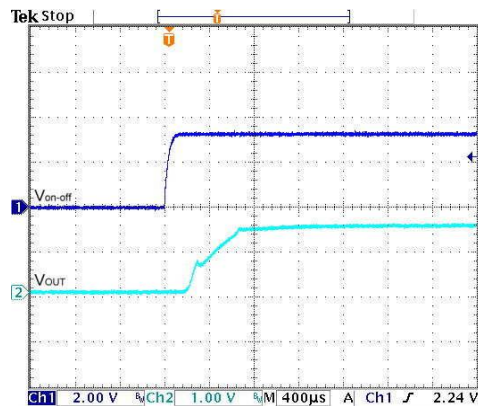

Using ON/OFF Voltage Start-Up and Vo Rise Characteristic  
Vin=Vin(nom), Full Load

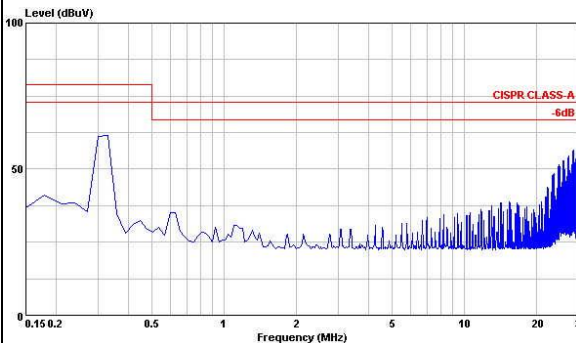

Conduction Emission of EN55022 Class A  
Vin=Vin(nom), Full Load

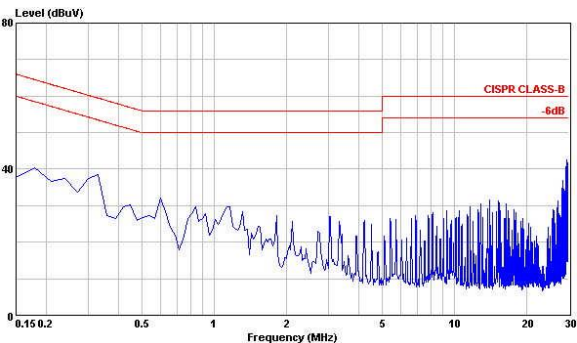

Conduction Emission of EN55022 Class B  
Vin=Vin(nom), Full Load

Characteristic Curves (Continued)

All test conditions are at 25°C. The figures are for PXE30-24WS1P8

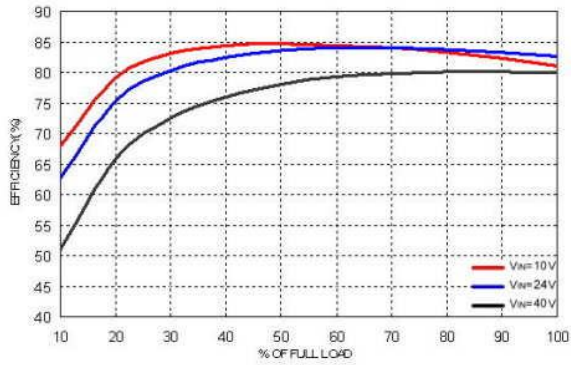

Efficiency Versus Output Current

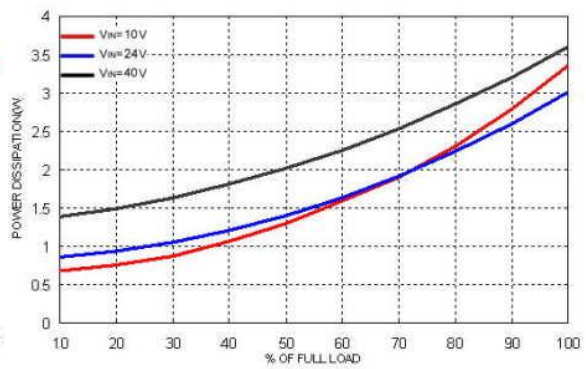

Power Dissipation Versus Output Current

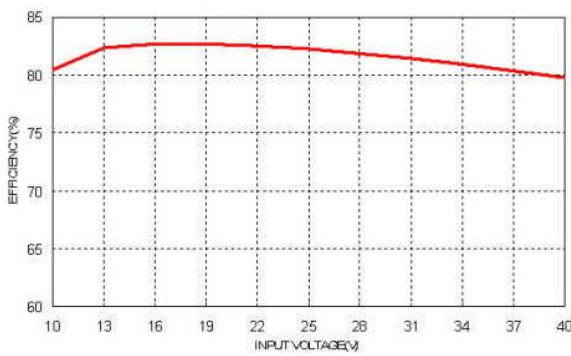

Efficiency Versus Input Voltage. Full Load

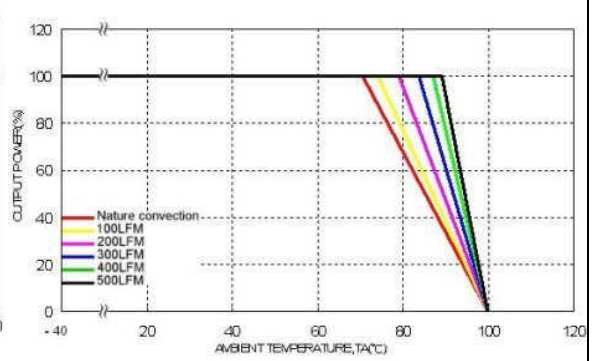

Derating Output Current Versus Ambient Temperature and Airflow Vin=Vin(nom)

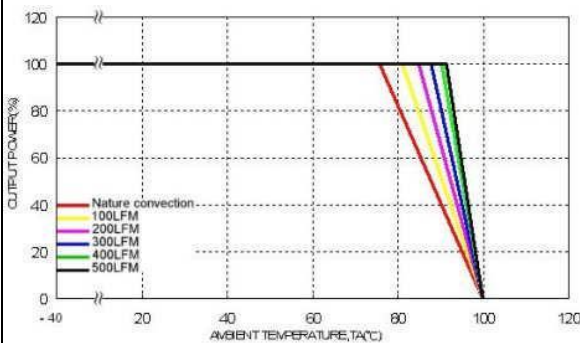

Derating Output Current Versus Ambient Temperature with Heat-Sink and Airflow, Vin = Vin(nom)

Characteristic Curves (Continued)

All test conditions are at 25°C. The figures are for PXE30-24WS1P8

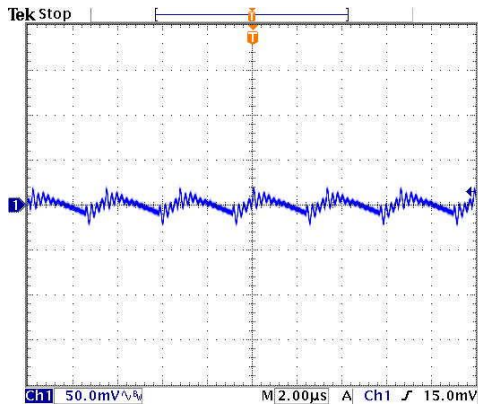

Typical Output Ripple and Noise.  
Vin=Vin(nom), Full Load

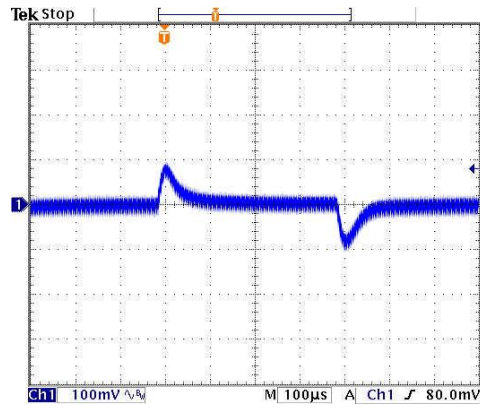

Transient Response to Dynamic Load Change from 100% to 75% to 100% of Full Load ; Vin=Vin(nom)

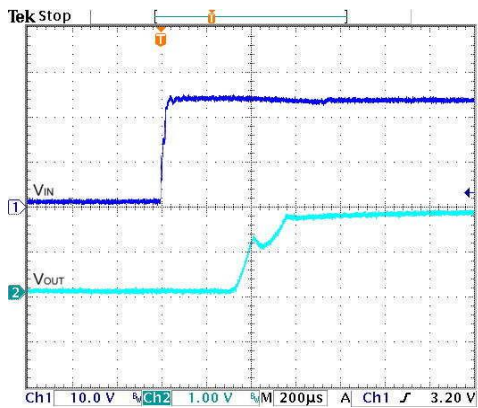

Typical Input Start-Up and Output Rise Characteristic  
Vin=Vin(nom), Full Load

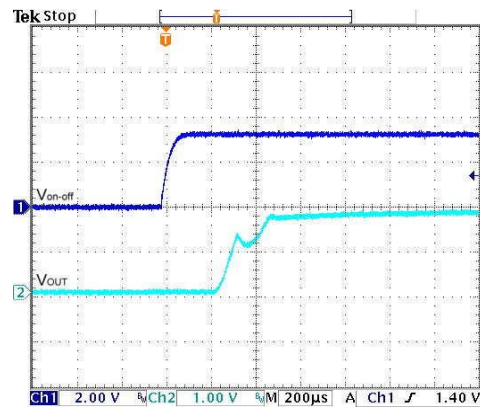

Using ON/OFF Voltage Start-Up and Vo Rise Characteristic  
Vin=Vin(nom), Full Load

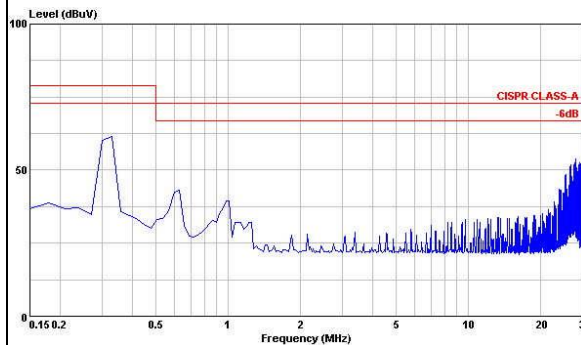

Conduction Emission of EN55022 Class A  
Vin=Vin(nom), Full Load

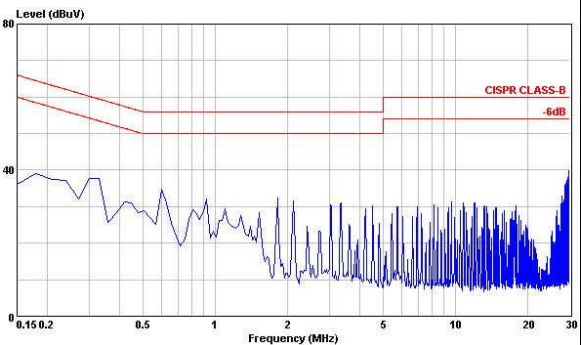

Conduction Emission of EN55022 Class B  
Vin=Vin(nom), Full Load



Characteristic Curves (Continued)

All test conditions are at 25°C. The figures are for PXE30-24WS2P5

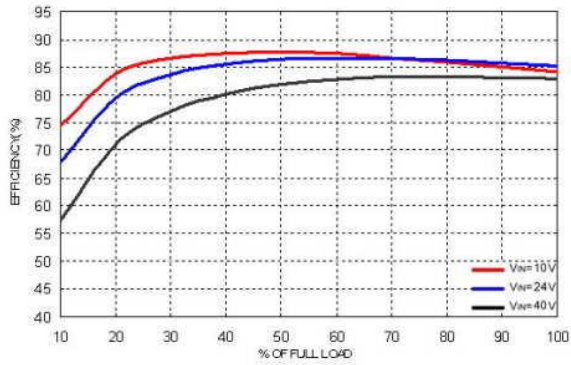

Efficiency Versus Output Current

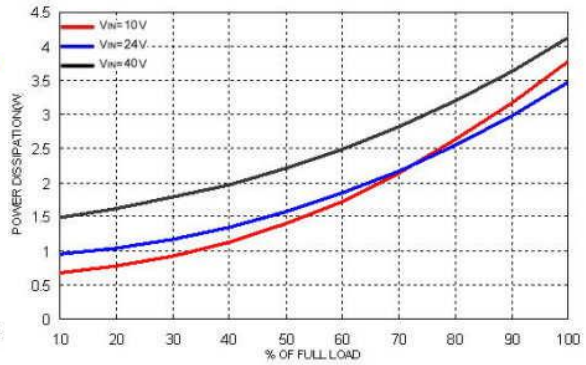

Power Dissipation Versus Output Current

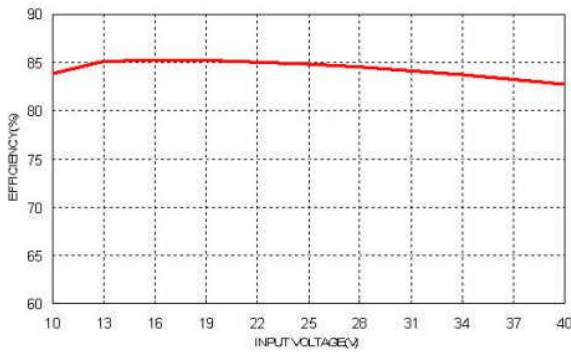

Efficiency Versus Input Voltage. Full Load

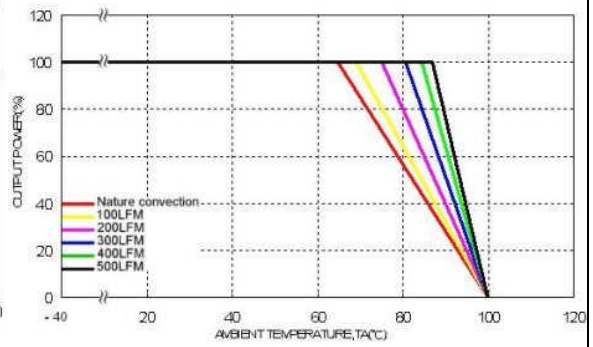

Derating Output Current Versus Ambient Temperature and Airflow Vin=Vin(nom)

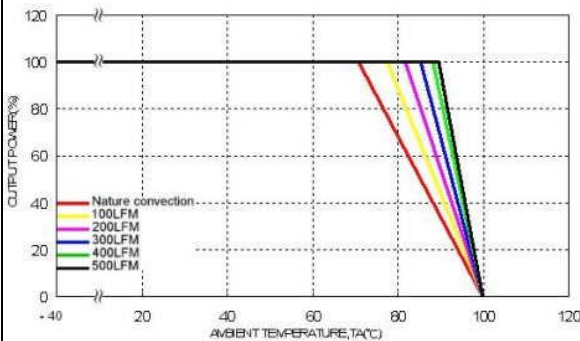

Derating Output Current Versus Ambient Temperature with Heat-Sink and Airflow, Vin = Vin(nom)

Characteristic Curves (Continued)

All test conditions are at 25°C. The figures are for PXE30-24WS2P5

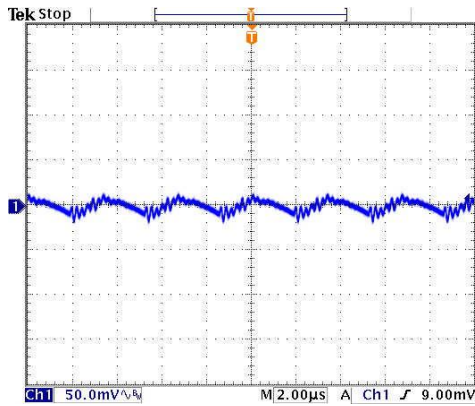

Typical Output Ripple and Noise.  
Vin=Vin(nom), Full Load

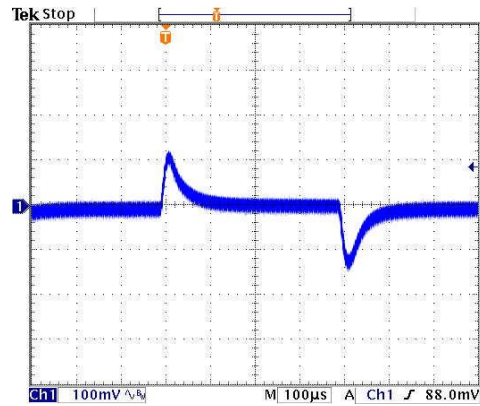

Transient Response to Dynamic Load Change from 100% to 75% to 100% of Full Load ; Vin=Vin(nom)

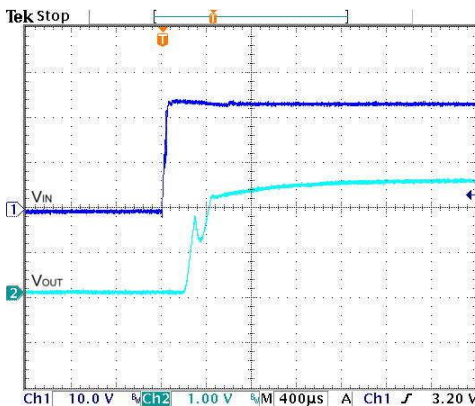

Typical Input Start-Up and Output Rise Characteristic  
Vin=Vin(nom), Full Load

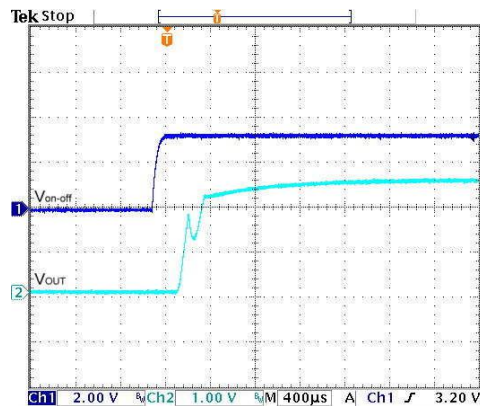

Using ON/OFF Voltage Start-Up and Vo Rise Characteristic  
Vin=Vin(nom), Full Load

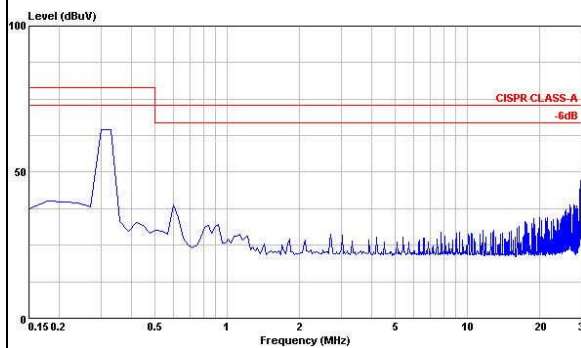

Conduction Emission of EN55022 Class A  
Vin=Vin(nom), Full Load

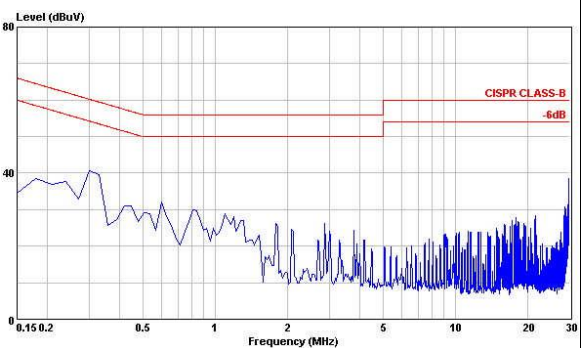

Conduction Emission of EN55022 Class B  
Vin=Vin(nom), Full Load

Characteristic Curves (Continued)

All test conditions are at 25°C. The figures are identical for PXE30-24WS3P3

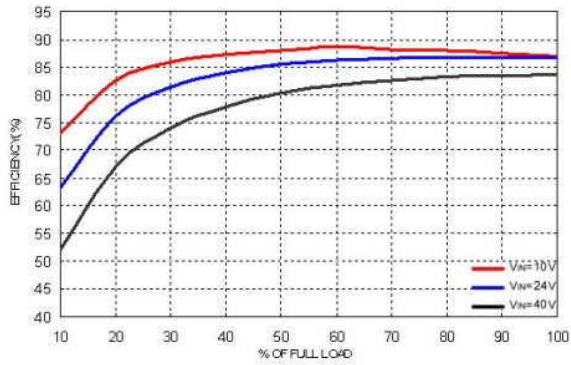

Efficiency Versus Output Current

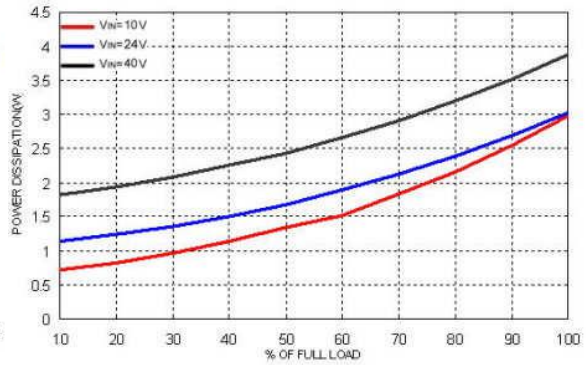

Power Dissipation Versus Output Current

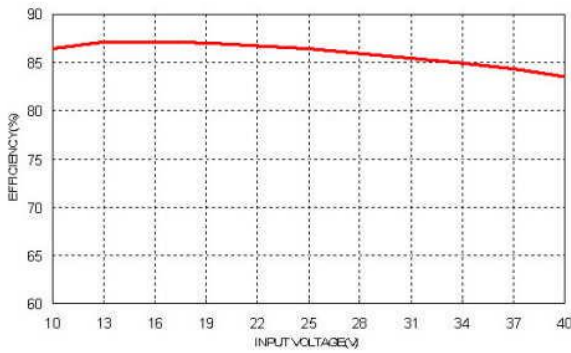

Efficiency Versus Input Voltage. Full Load

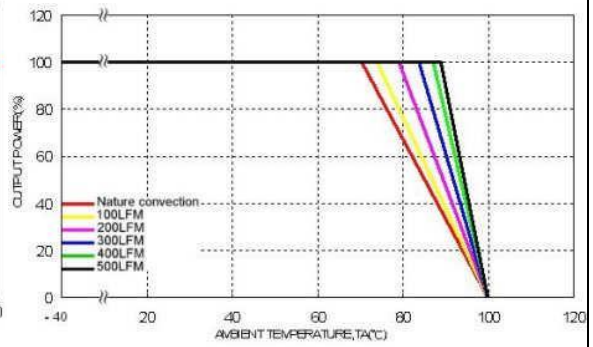

Derating Output Current Versus Ambient Temperature and Airflow Vin=Vin(nom)

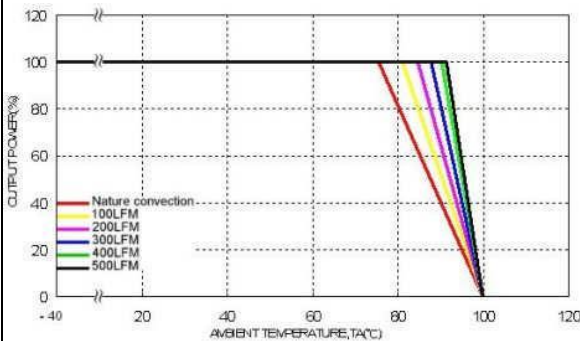

Derating Output Current Versus Ambient Temperature with Heat-Sink and Airflow, Vin = Vin(nom)

Characteristic Curves (Continued)

All test conditions are at 25°C. The figures are for PXE30-24WS3P3

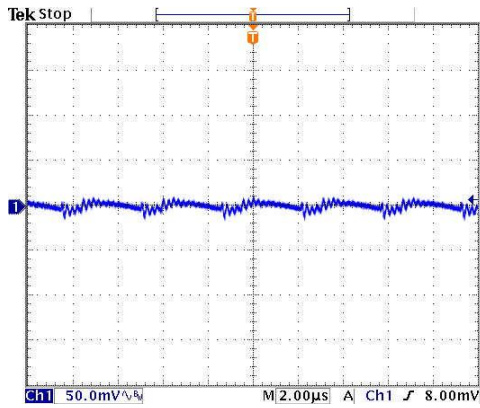

Typical Output Ripple and Noise.  
Vin=Vin(nom), Full Load

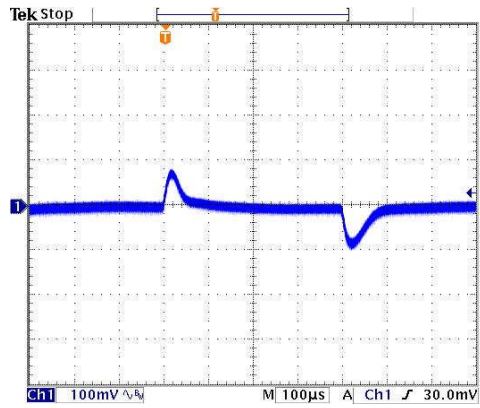

Transient Response to Dynamic Load Change from 100% to 75% to 100% of Full Load ; Vin=Vin(nom)

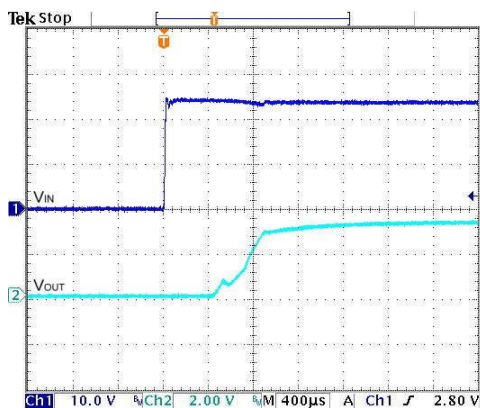

Typical Input Start-Up and Output Rise Characteristic  
Vin=Vin(nom), Full Load

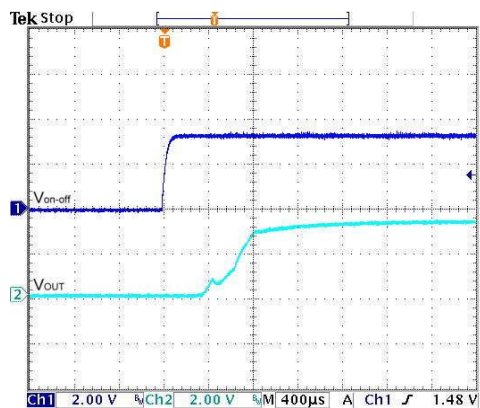

Using ON/OFF Voltage Start-Up and V<sub>O</sub> Rise Characteristic  
Vin=Vin(nom), Full Load

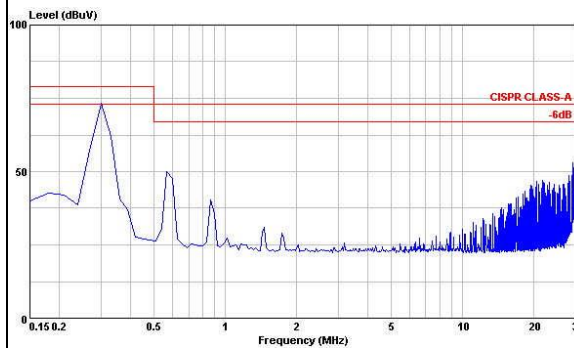

Conduction Emission of EN55022 Class A  
Vin=Vin(nom), Full Load

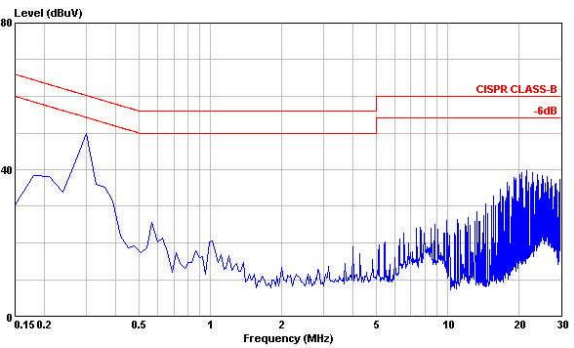

Conduction Emission of EN55022 Class B  
Vin=Vin(nom), Full Load

Characteristic Curves (Continued)

All test conditions are at 25°C. The figures are for PXE30-24WS05

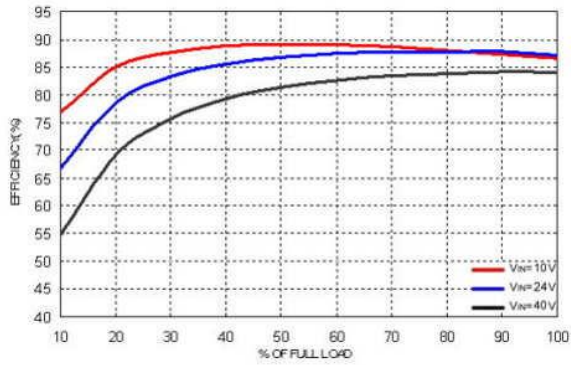

Efficiency Versus Output Current

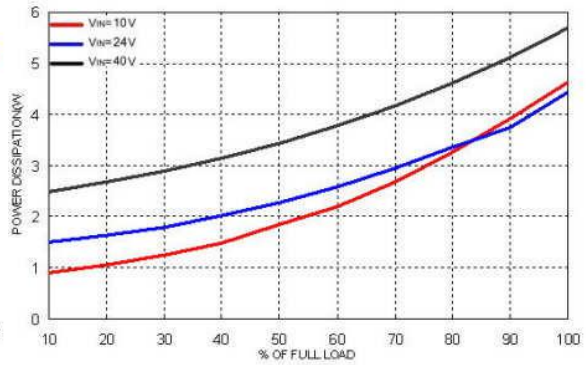

Power Dissipation Versus Output Current

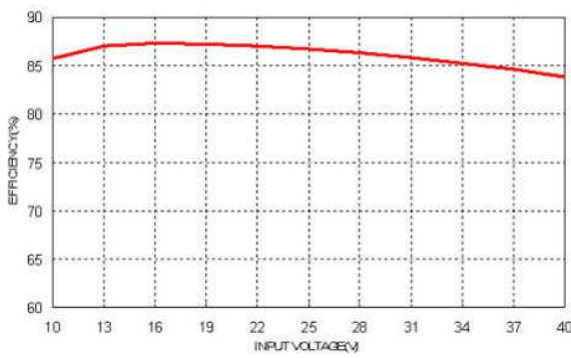

Efficiency Versus Input Voltage. Full Load

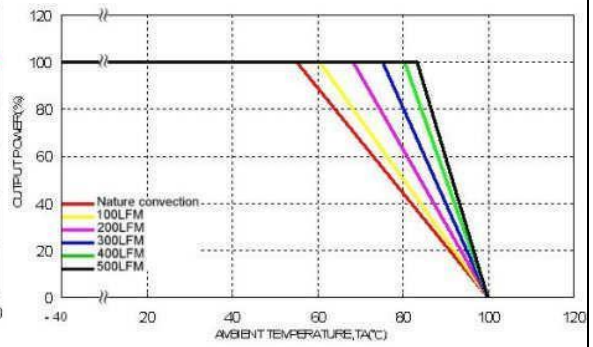

Derating Output Current Versus Ambient Temperature and Airflow Vin=Vin(nom)

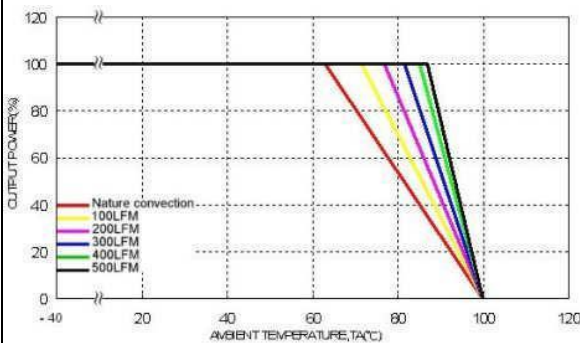

Derating Output Current Versus Ambient Temperature with Heat-Sink and Airflow, Vin = Vin(nom)

Characteristic Curves (Continued)

All test conditions are at 25°C. The figures are for PXE30-24WS05

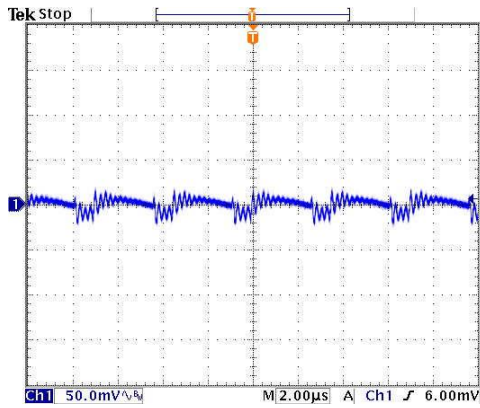

Typical Output Ripple and Noise.  
Vin=Vin(nom), Full Load

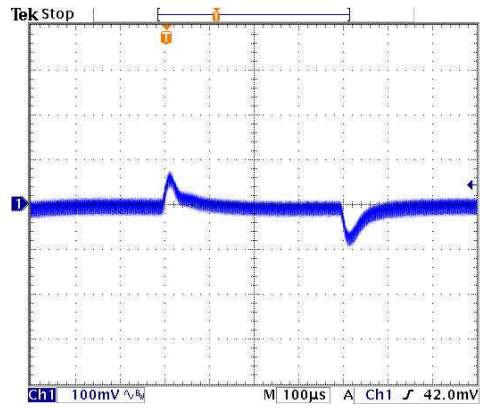

Transient Response to Dynamic Load Change from 100% to 75% to 100% of Full Load ; Vin=Vin(nom)

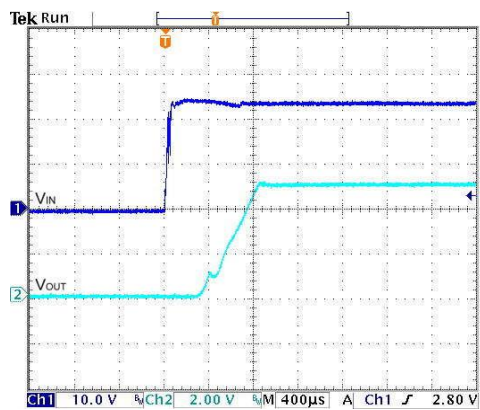

Typical Input Start-Up and Output Rise Characteristic  
Vin=Vin(nom), Full Load

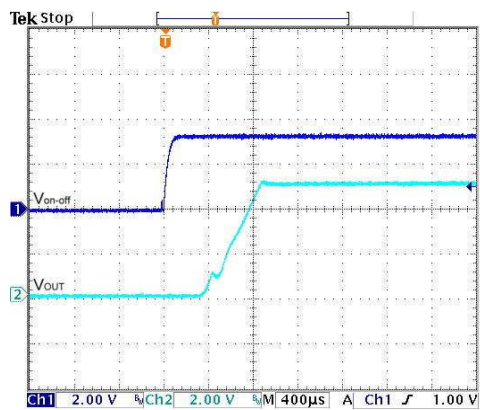

Using ON/OFF Voltage Start-Up and V<sub>o</sub> Rise Characteristic  
Vin=Vin(nom), Full Load

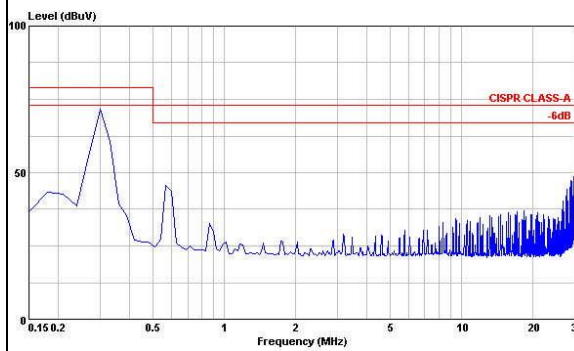

Conduction Emission of EN55022 Class A  
Vin=Vin(nom), Full Load

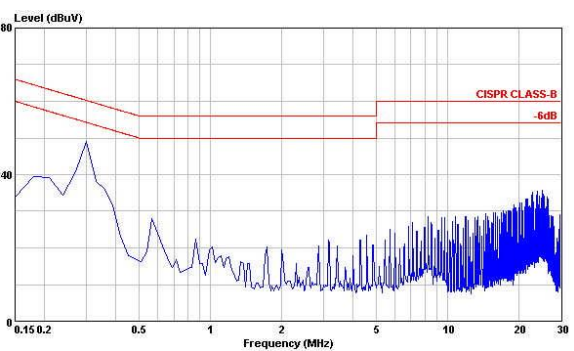

Conduction Emission of EN55022 Class B  
Vin=Vin(nom), Full Load

Characteristic Curves (Continued)

All test conditions are at 25°C. The figures are for PXE30-24WS12

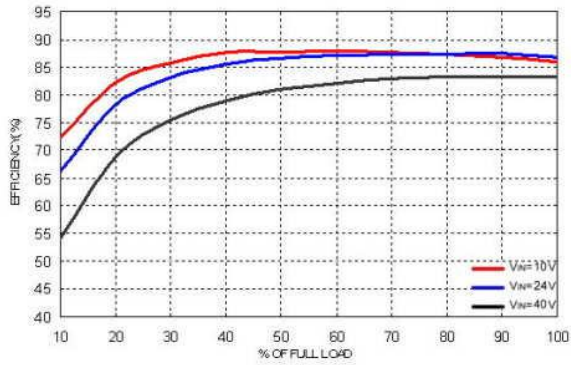

Efficiency Versus Output Current

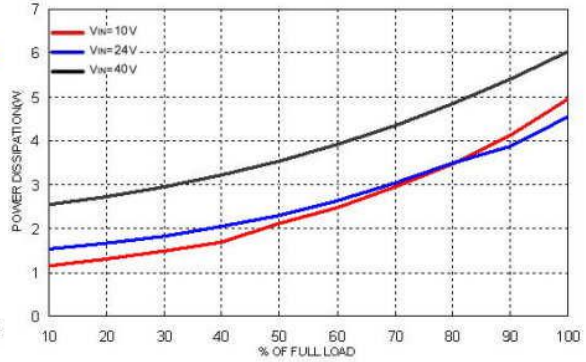

Power Dissipation Versus Output Current

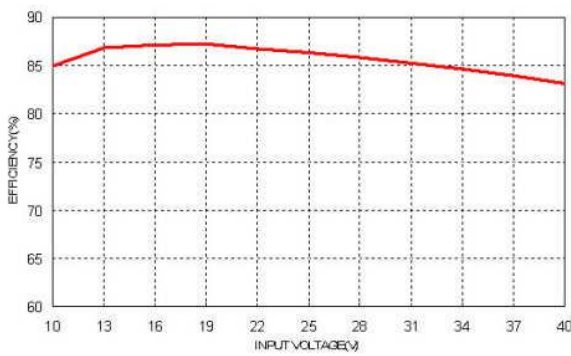

Efficiency Versus Input Voltage. Full Load

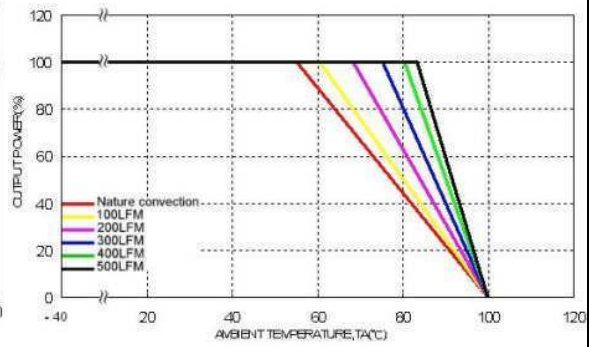

Derating Output Current Versus Ambient Temperature and Airflow Vin=Vin(nom)

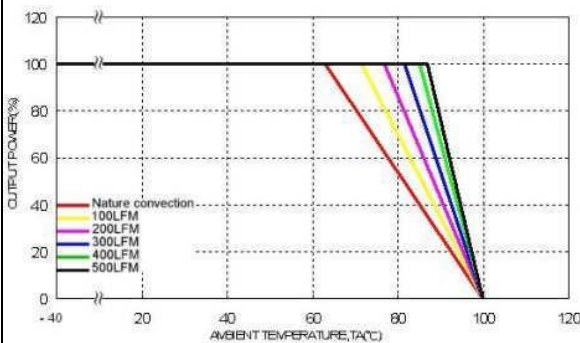

Derating Output Current Versus Ambient Temperature with Heat-Sink and Airflow, Vin = Vin(nom)

Characteristic Curves (Continued)

All test conditions are at 25°C. The figures are for PXE30-24WS12

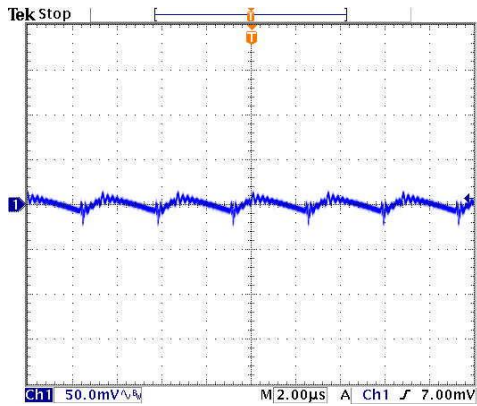

Typical Output Ripple and Noise.  
Vin=Vin(nom), Full Load

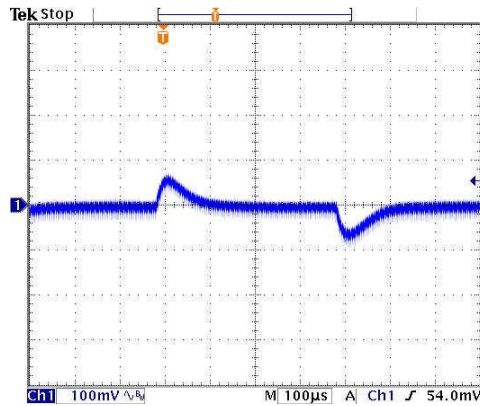

Transient Response to Dynamic Load Change from 100% to 75% to 100% of Full Load ; Vin=Vin(nom)

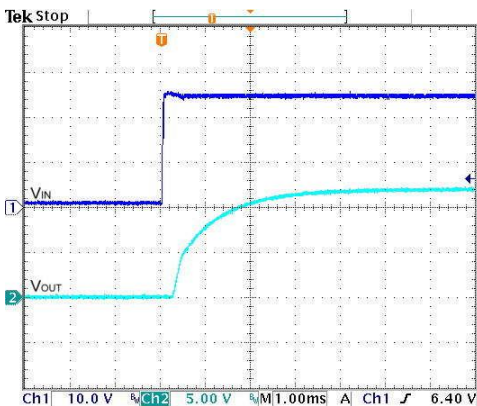

Typical Input Start-Up and Output Rise Characteristic  
Vin=Vin(nom), Full Load

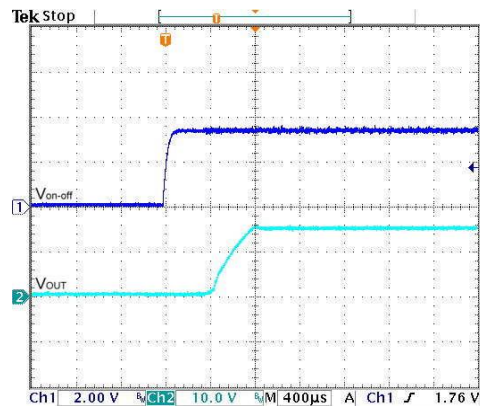

Using ON/OFF Voltage Start-Up and V<sub>O</sub> Rise Characteristic  
Vin=Vin(nom), Full Load

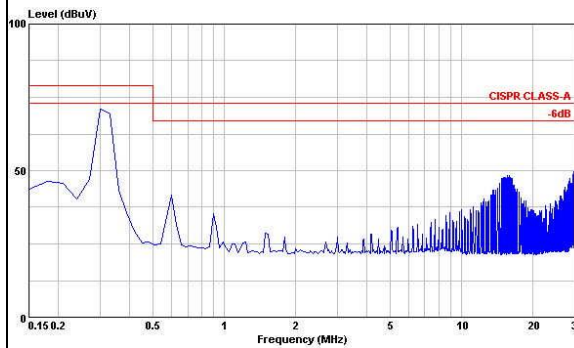

Conduction Emission of EN55022 Class A  
Vin=Vin(nom), Full Load

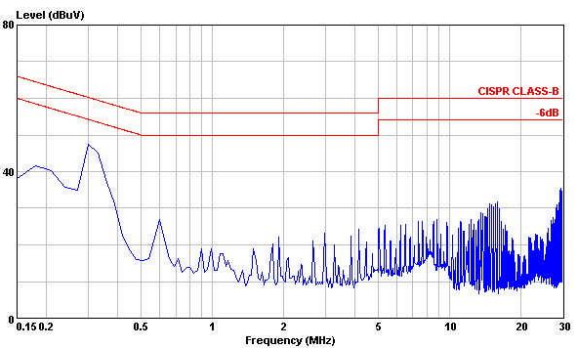

Conduction Emission of EN55022 Class B  
Vin=Vin(nom), Full Load



Characteristic Curves (Continued)

All test conditions are at 25°C. The figures are for PXE30-24WS15

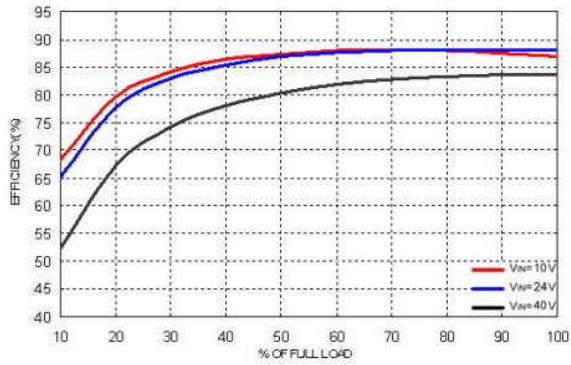

Efficiency Versus Output Current

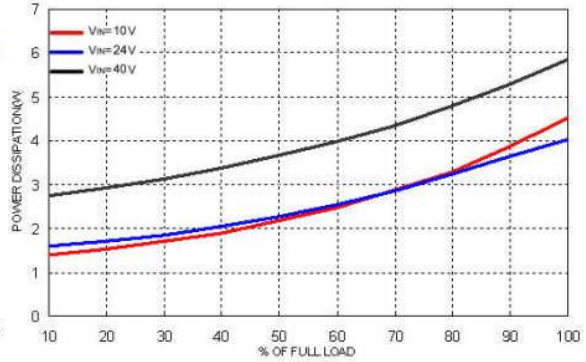

Power Dissipation Versus Output Current

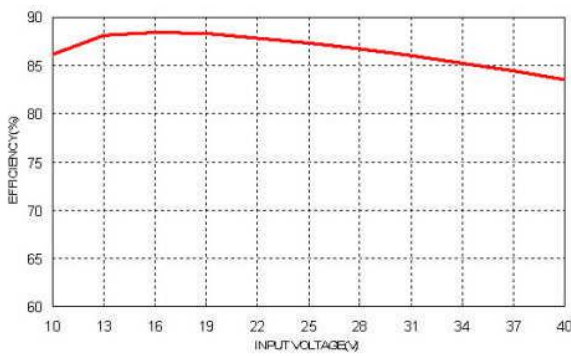

Efficiency Versus Input Voltage. Full Load

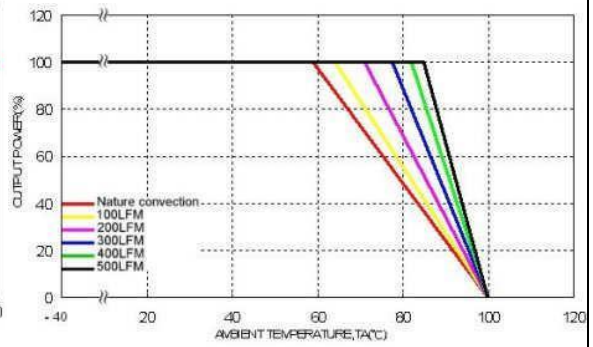

Derating Output Current Versus Ambient Temperature and Airflow  $V_{in}=V_{in}(nom)$

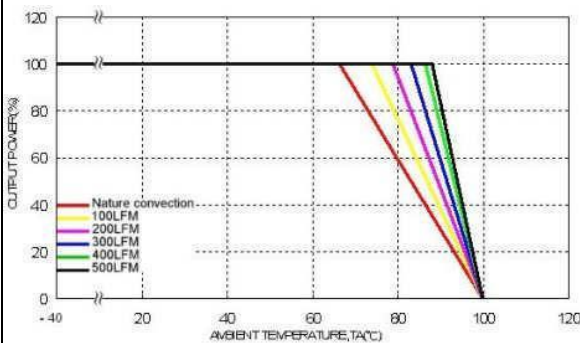

Derating Output Current Versus Ambient Temperature with Heat-Sink and Airflow,  $V_{in} = V_{in}(nom)$

Characteristic Curves (Continued)

All test conditions are at 25°C. The figures are identical for PXE30-24WS15

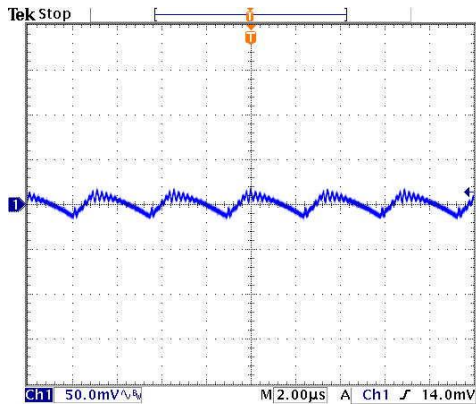

Typical Output Ripple and Noise.  
Vin=Vin(nom), Full Load

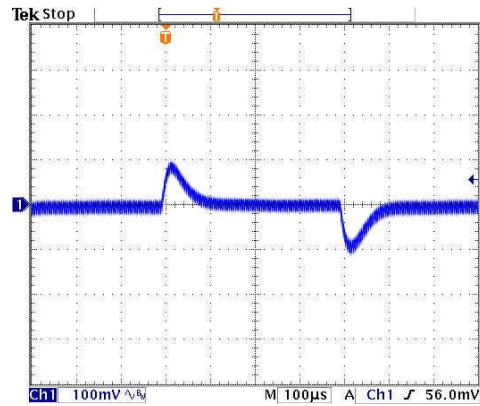

Transient Response to Dynamic Load Change from 100% to 75% to 100% of Full Load ; Vin=Vin(nom)

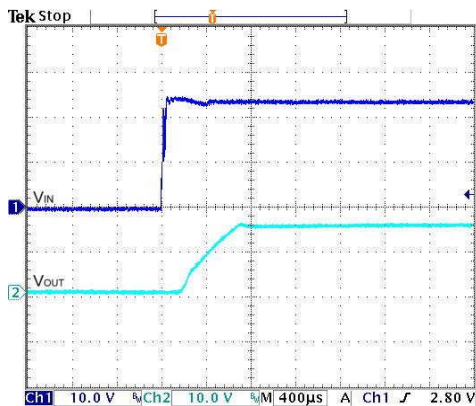

Typical Input Start-Up and Output Rise Characteristic  
Vin=Vin(nom), Full Load

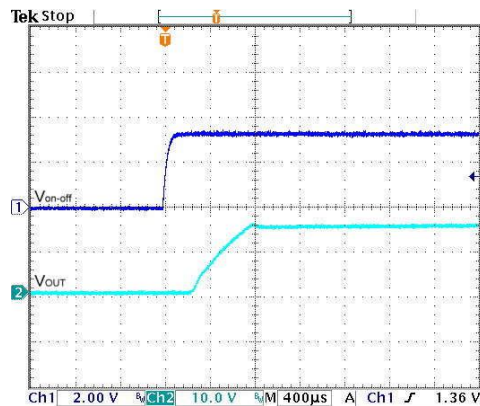

Using ON/OFF Voltage Start-Up and V<sub>O</sub> Rise Characteristic  
Vin=Vin(nom), Full Load

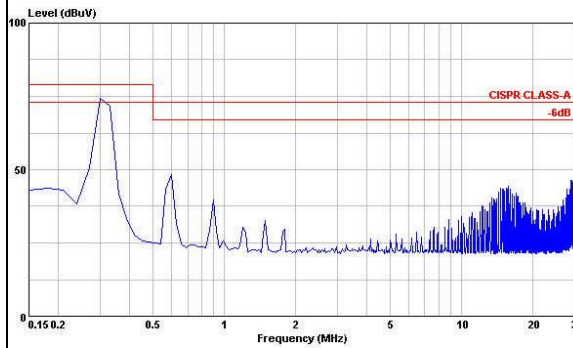

Conduction Emission of EN55022 Class A  
Vin=Vin(nom), Full Load

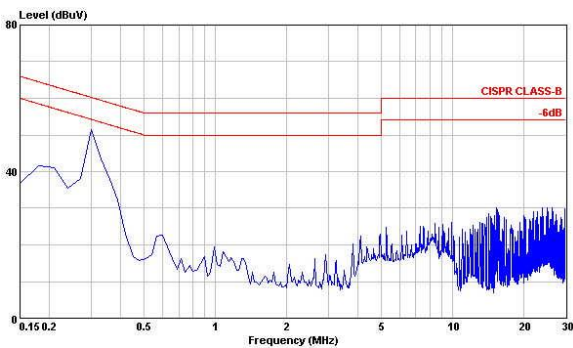

Conduction Emission of EN55022 Class B  
Vin=Vin(nom), Full Load

Characteristic Curves (Continued)

All test conditions are at 25°C. The figures are for PXE30-48WS1P5

Efficiency Versus Output Current

Power Dissipation Versus Output Current

Efficiency Versus Input Voltage. Full Load

Derating Output Current Versus Ambient Temperature and  
Airflow  $V_{in}=V_{in(nom)}$

Derating Output Current Versus Ambient Temperature with Heat-Sink  
and Airflow,  $V_{in} = V_{in(nom)}$

Characteristic Curves (Continued)

All test conditions are at 25°C. The figures are for PXE30-48WS1P5

Typical Output Ripple and Noise.  
Vin=Vin(nom), Full Load

Transient Response to Dynamic Load Change from  
100% to 75% to 100% of Full Load ; Vin=Vin(nom)

Typical Input Start-Up and Output Rise Characteristic  
Vin=Vin(nom), Full Load

Using ON/OFF Voltage Start-Up and Vo Rise Characteristic  
Vin=Vin(nom), Full Load

Conduction Emission of EN55022 Class A  
Vin=Vin(nom), Full Load

Conduction Emission of EN55022 Class B  
Vin=Vin(nom), Full Load

Characteristic Curves (Continued)

All test conditions are at 25°C. The figures are for PXE30-48WS1P8

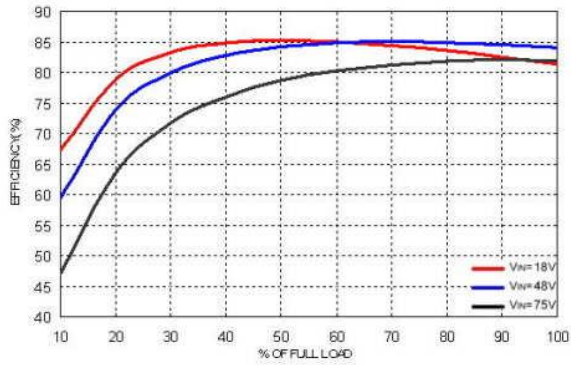

Efficiency Versus Output Current

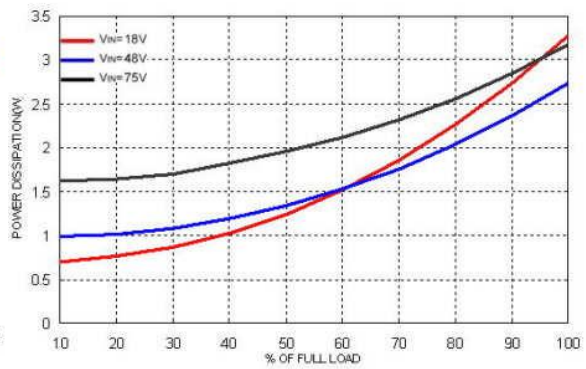

Power Dissipation Versus Output Current

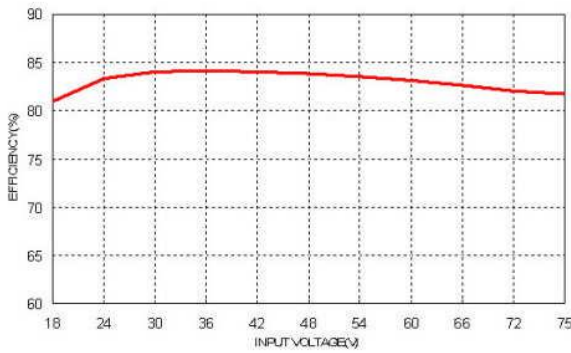

Efficiency Versus Input Voltage. Full Load

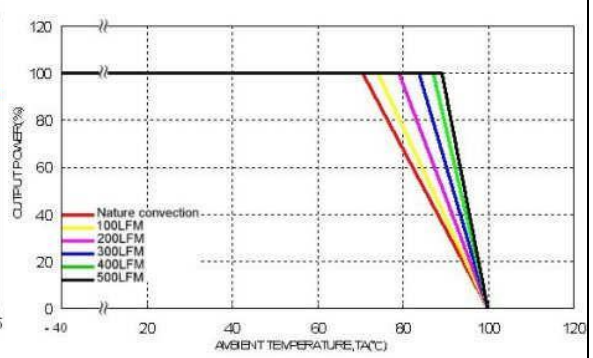

Derating Output Current Versus Ambient Temperature and Airflow Vin=Vin(nom)

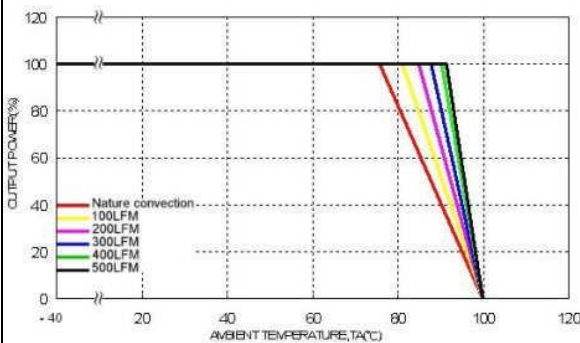

Derating Output Current Versus Ambient Temperature with Heat-Sink and Airflow, Vin = Vin(nom)

Characteristic Curves (Continued)

All test conditions are at 25°C. The figures are for PXE30-48WS1P8

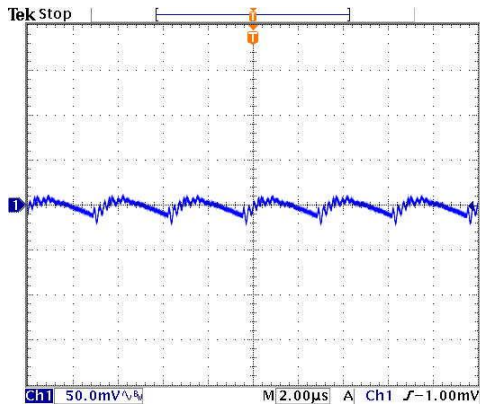

Typical Output Ripple and Noise.  
Vin=Vin(nom), Full Load

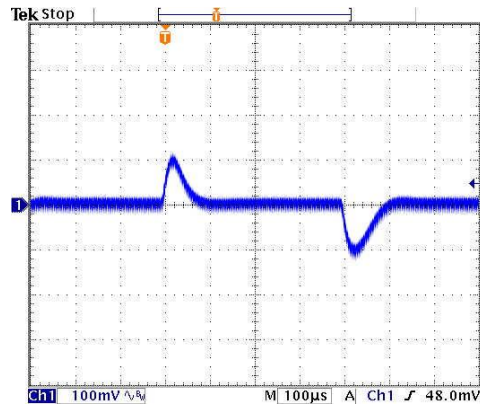

Transient Response to Dynamic Load Change from 100% to 75% to 100% of Full Load ; Vin=Vin(nom)

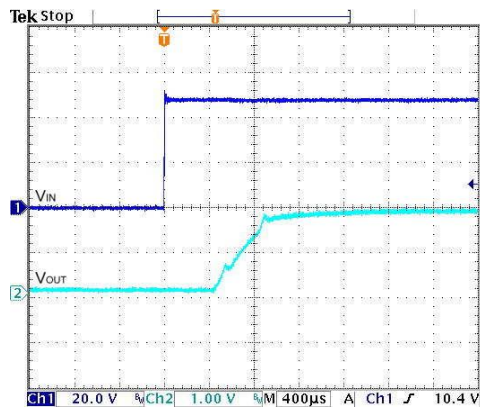

Typical Input Start-Up and Output Rise Characteristic  
Vin=Vin(nom), Full Load

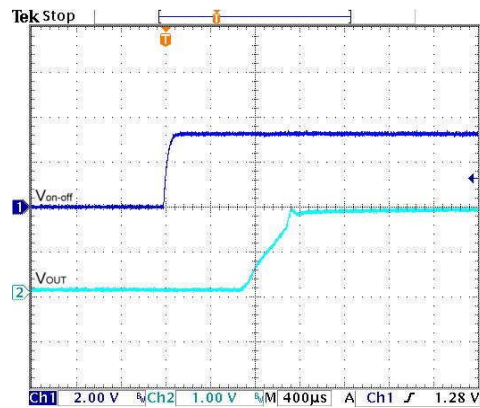

Using ON/OFF Voltage Start-Up and V<sub>O</sub> Rise Characteristic  
Vin=Vin(nom), Full Load

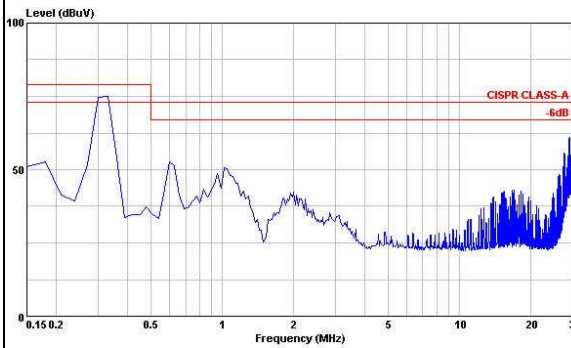

Conduction Emission of EN55022 Class A  
Vin=Vin(nom), Full Load

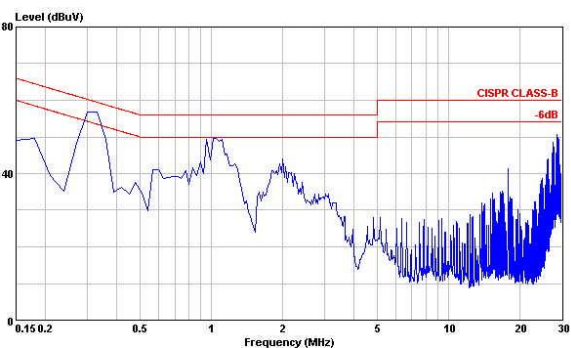

Conduction Emission of EN55022 Class B  
Vin=Vin(nom), Full Load

Characteristic Curves (Continued)

All test conditions are at 25°C. The figures are for PXE30-48WS2P5

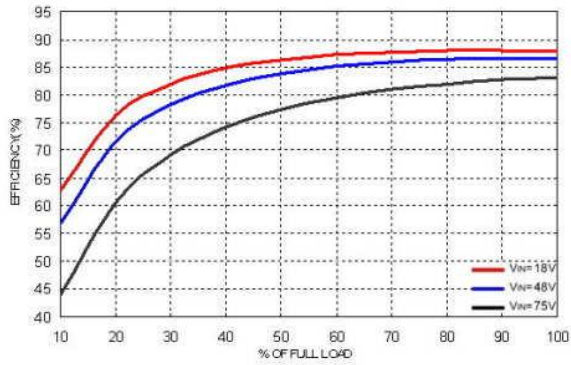

Efficiency Versus Output Current

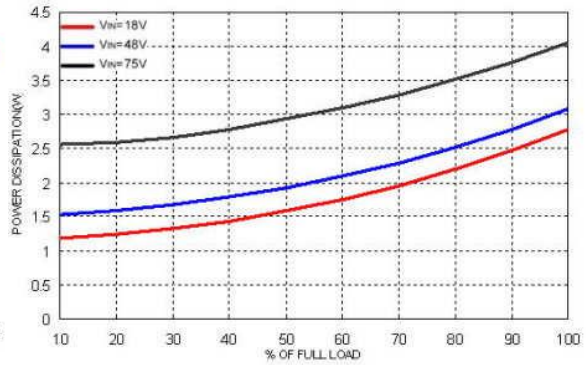

Power Dissipation Versus Output Current

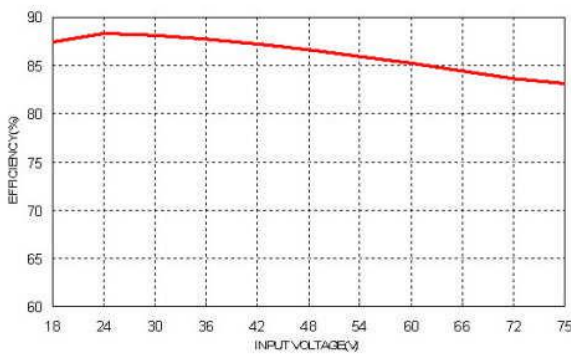

Efficiency Versus Input Voltage. Full Load

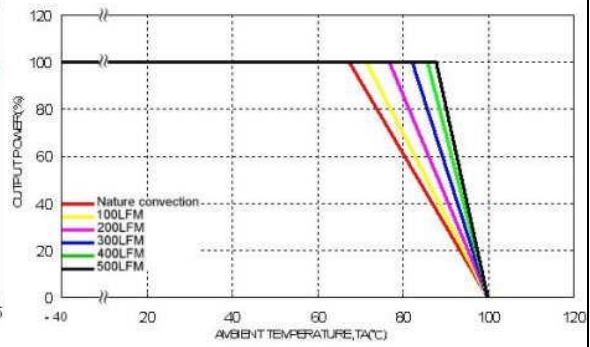

Derating Output Current Versus Ambient Temperature and Airflow Vin=Vin(nom)

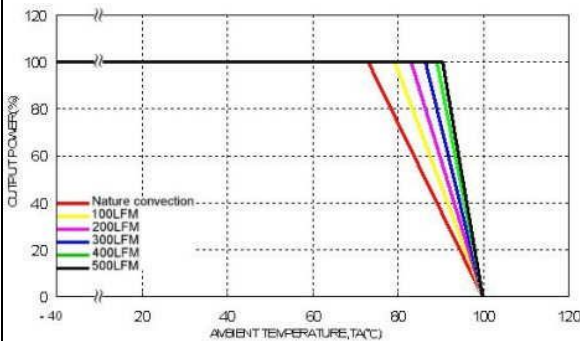

Derating Output Current Versus Ambient Temperature with Heat-Sink and Airflow, Vin = Vin(nom)

Characteristic Curves (Continued)

All test conditions are at 25°C. The figures are for PXE30-48WS2P5

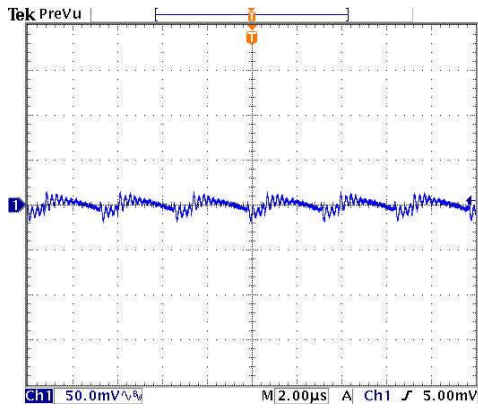

Typical Output Ripple and Noise.  
Vin=Vin(nom), Full Load

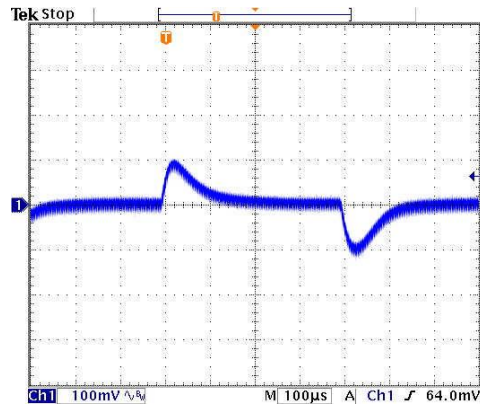

Transient Response to Dynamic Load Change from 100% to 75% to 100% of Full Load ; Vin=Vin(nom)

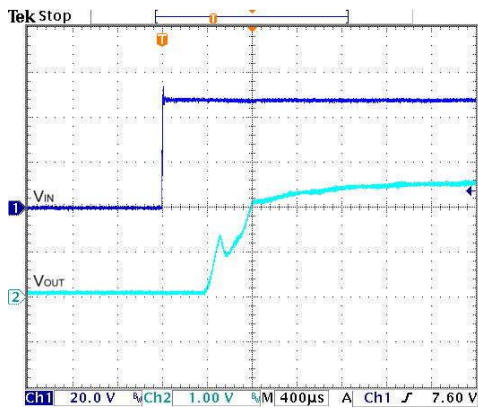

Typical Input Start-Up and Output Rise Characteristic  
Vin=Vin(nom), Full Load

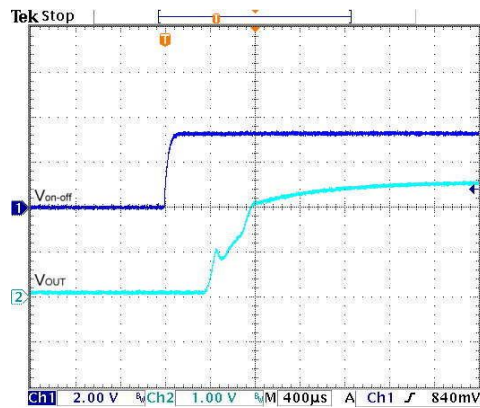

Using ON/OFF Voltage Start-Up and Vo Rise Characteristic  
Vin=Vin(nom), Full Load

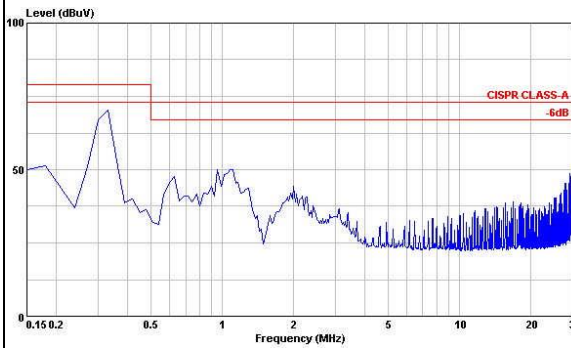

Conduction Emission of EN55022 Class A  
Vin=Vin(nom), Full Load

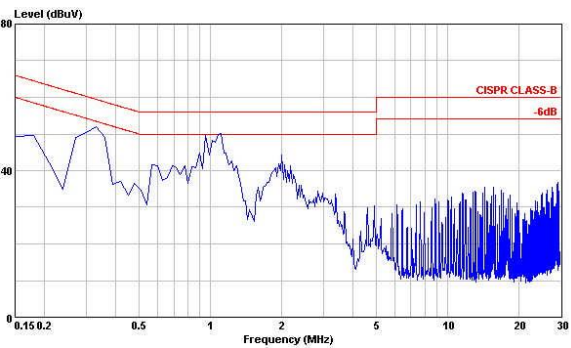

Conduction Emission of EN55022 Class B  
Vin=Vin(nom), Full Load



Characteristic Curves (Continued)

All test conditions are at 25°C. The figures are for PXE30-48WS3P3

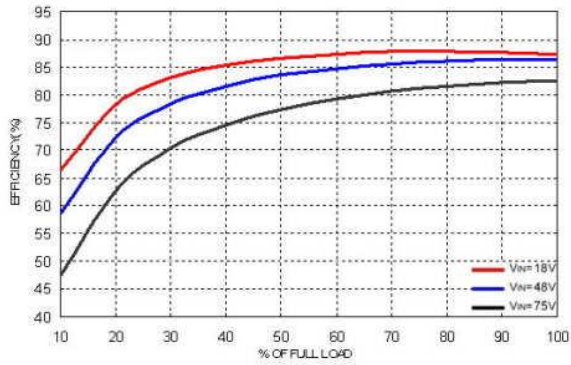

Efficiency Versus Output Current

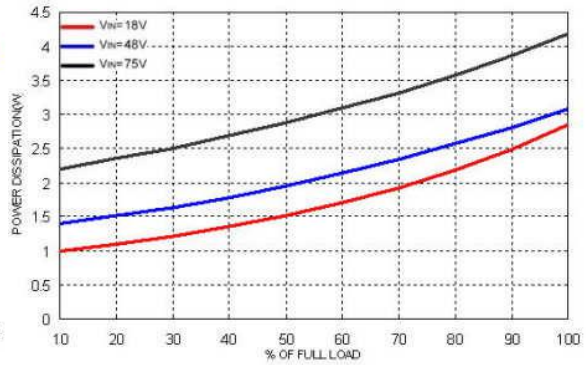

Power Dissipation Versus Output Current

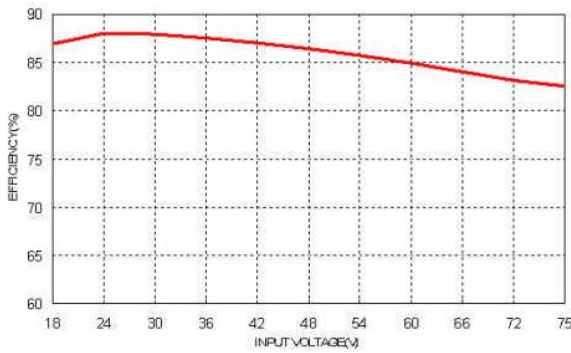

Efficiency Versus Input Voltage. Full Load

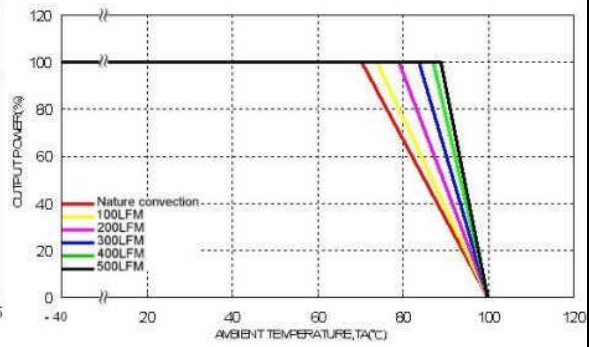

Derating Output Current Versus Ambient Temperature and Airflow Vin=Vin(nom)

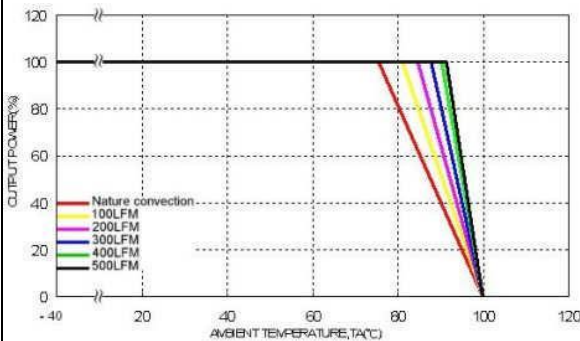

Derating Output Current Versus Ambient Temperature with Heat-Sink and Airflow, Vin = Vin(nom)

Characteristic Curves (Continued)

All test conditions are at 25°C. The figures are for PXE30-48WS3P3

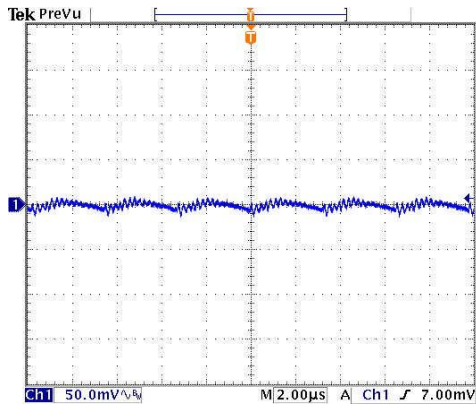

Typical Output Ripple and Noise.  
Vin=Vin(nom), Full Load

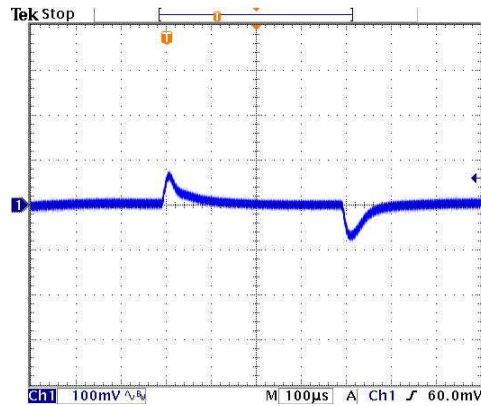

Transient Response to Dynamic Load Change from 100% to 75% to 100% of Full Load ; Vin=Vin(nom)

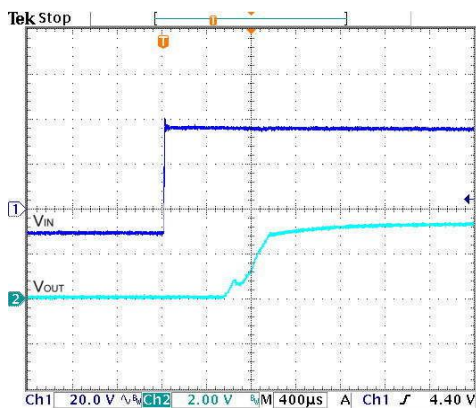

Typical Input Start-Up and Output Rise Characteristic  
Vin=Vin(nom), Full Load

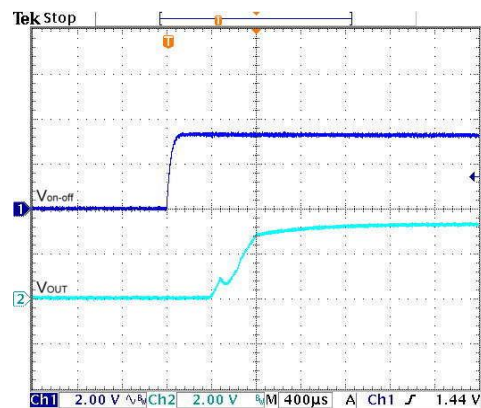

Using ON/OFF Voltage Start-Up and V<sub>O</sub> Rise Characteristic  
Vin=Vin(nom), Full Load

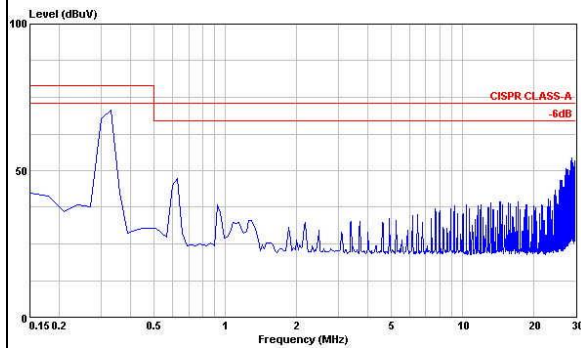

Conduction Emission of EN55022 Class A  
Vin=Vin(nom), Full Load

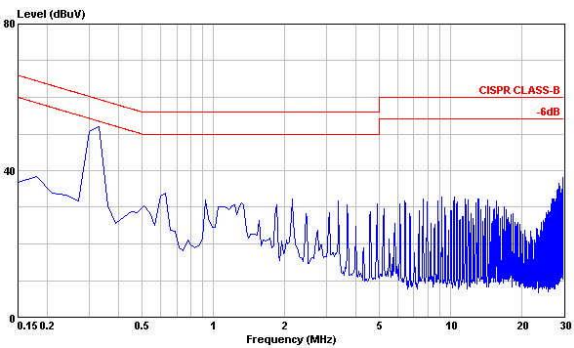

Conduction Emission of EN55022 Class B  
Vin=Vin(nom), Full Load

Characteristic Curves (Continued)

All test conditions are at 25°C. The figures are for PXE30-48WS05

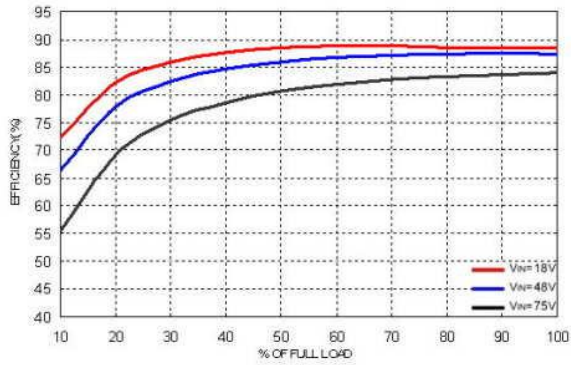

Efficiency Versus Output Current

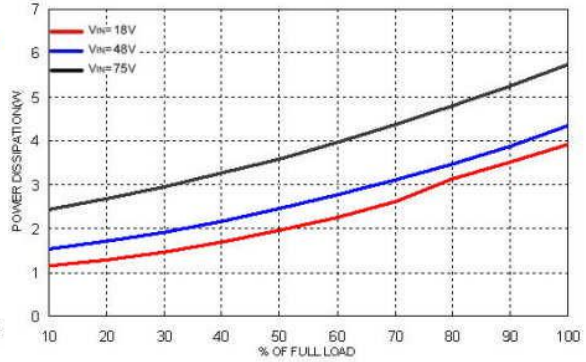

Power Dissipation Versus Output Current

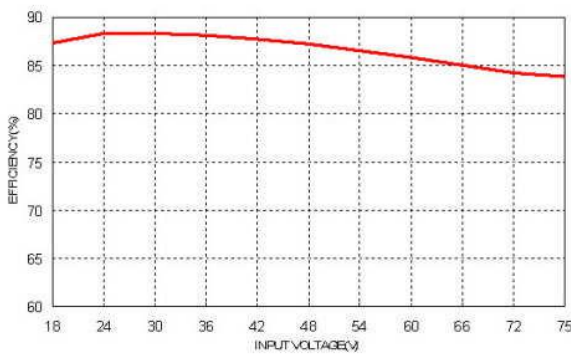

Efficiency Versus Input Voltage. Full Load

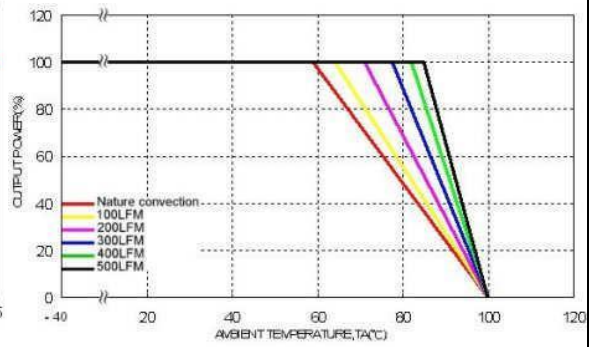

Derating Output Current Versus Ambient Temperature and Airflow Vin=Vin(nom)

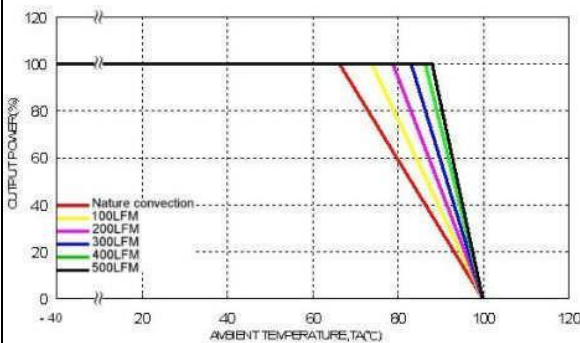

Derating Output Current Versus Ambient Temperature with Heat-Sink and Airflow, Vin = Vin(nom)

Characteristic Curves (Continued)

All test conditions are at 25°C. The figures are identical for PXE30-48WS05

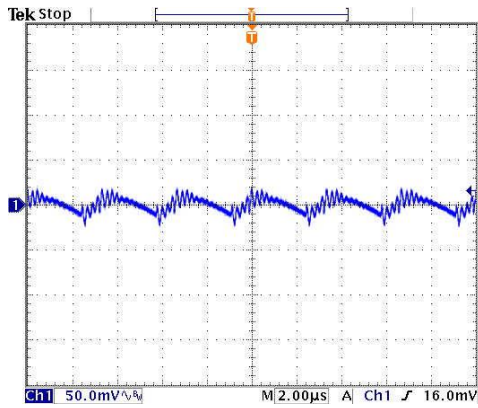

Typical Output Ripple and Noise.  
Vin=Vin(nom), Full Load

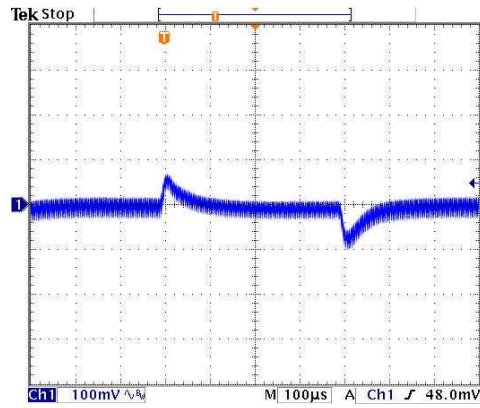

Transient Response to Dynamic Load Change from 100% to 75% to 100% of Full Load ; Vin=Vin(nom)

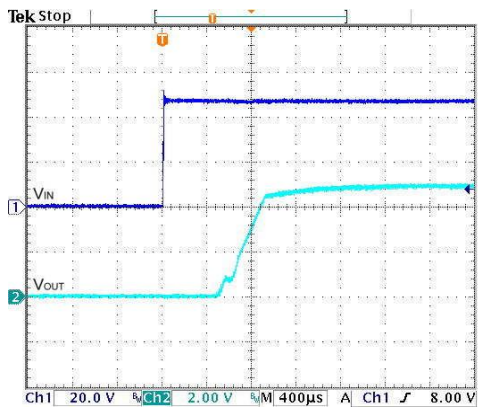

Typical Input Start-Up and Output Rise Characteristic  
Vin=Vin(nom), Full Load

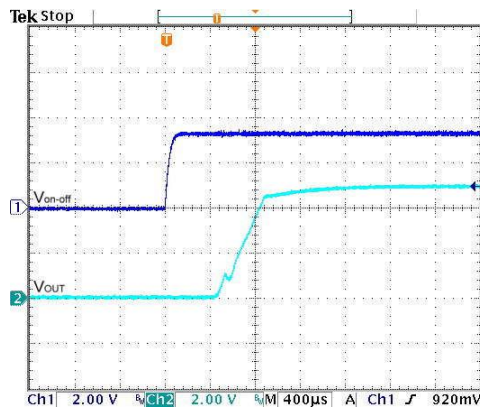

Using ON/OFF Voltage Start-Up and Vo Rise Characteristic  
Vin=Vin(nom), Full Load

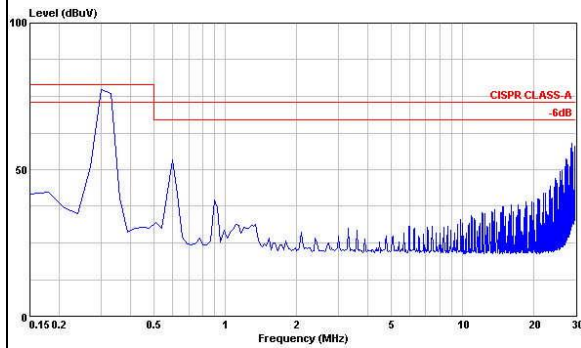

Conduction Emission of EN55022 Class A  
Vin=Vin(nom), Full Load

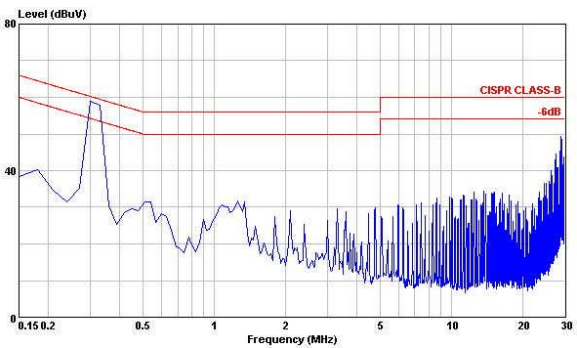

Conduction Emission of EN55022 Class B  
Vin=Vin(nom), Full Load

Characteristic Curves (Continued)

All test conditions are at 25°C. The figures are for PXE30-48WS12

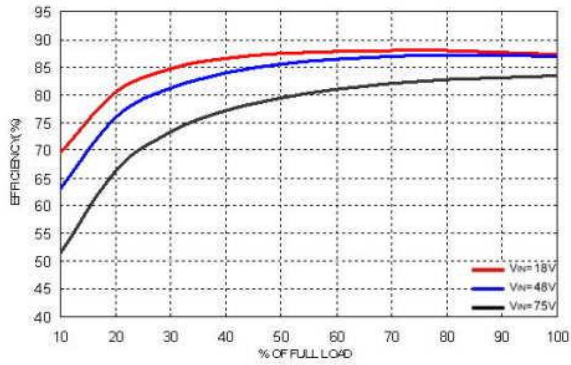

Efficiency Versus Output Current

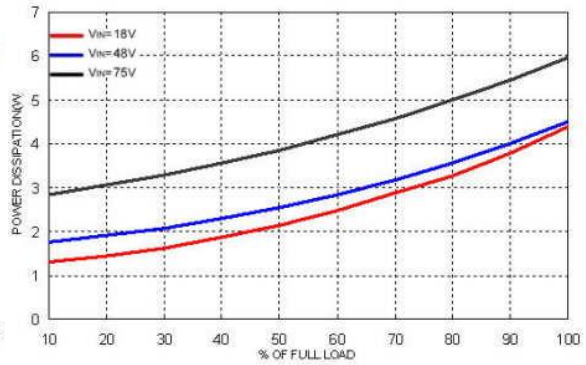

Power Dissipation Versus Output Current

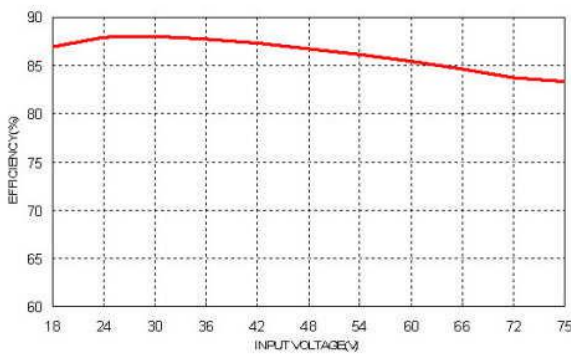

Efficiency Versus Input Voltage. Full Load

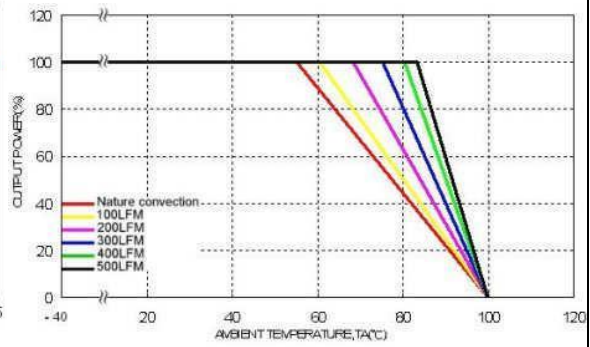

Derating Output Current Versus Ambient Temperature and Airflow Vin=Vin(nom)

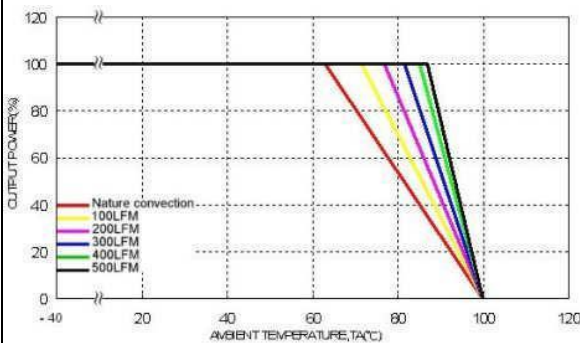

Derating Output Current Versus Ambient Temperature with Heat-Sink and Airflow, Vin = Vin(nom)

Characteristic Curves (Continued)

All test conditions are at 25°C. The figures are for PXE30-48WS12

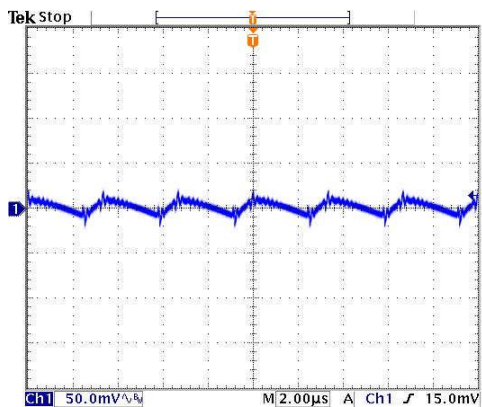

Typical Output Ripple and Noise.  
Vin=Vin(nom), Full Load

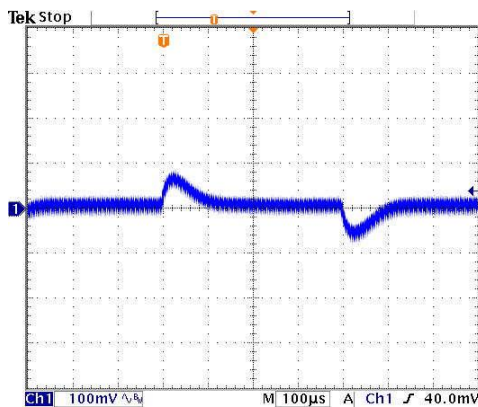

Transient Response to Dynamic Load Change from 100% to 75% to 100% of Full Load ; Vin=Vin(nom)

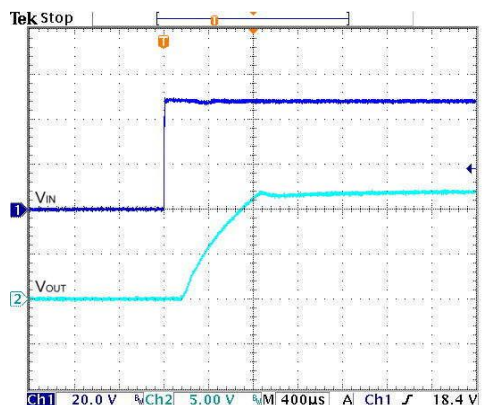

Typical Input Start-Up and Output Rise Characteristic  
Vin=Vin(nom), Full Load

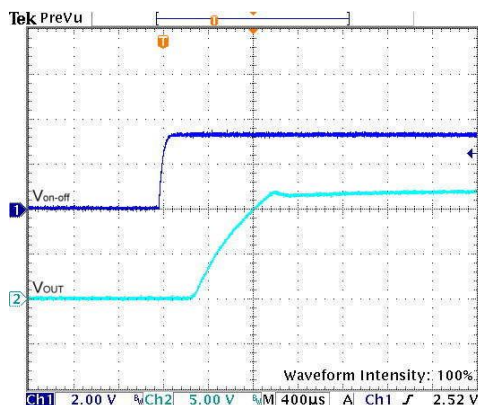

Using ON/OFF Voltage Start-Up and Vo Rise Characteristic  
Vin=Vin(nom), Full Load

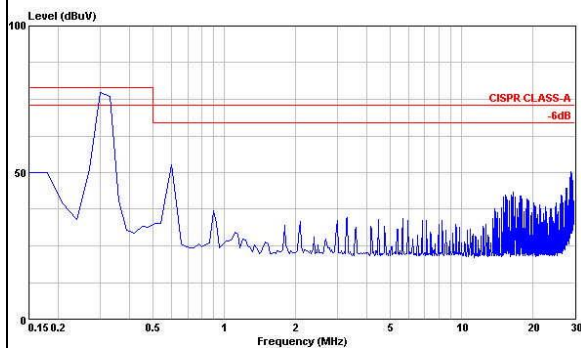

Conduction Emission of EN55022 Class A  
Vin=Vin(nom), Full Load

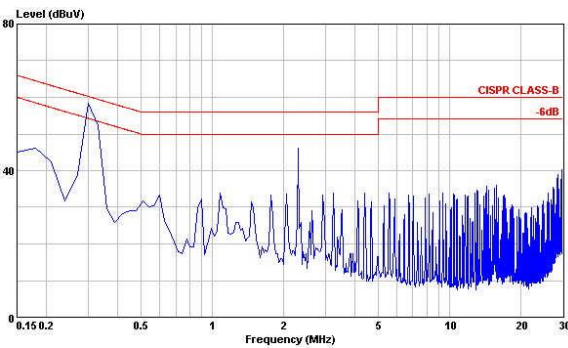

Conduction Emission of EN55022 Class B  
Vin=Vin(nom), Full Load

Characteristic Curves (Continued)

All test conditions are at 25°C. The figures are for PXE30-48WS15

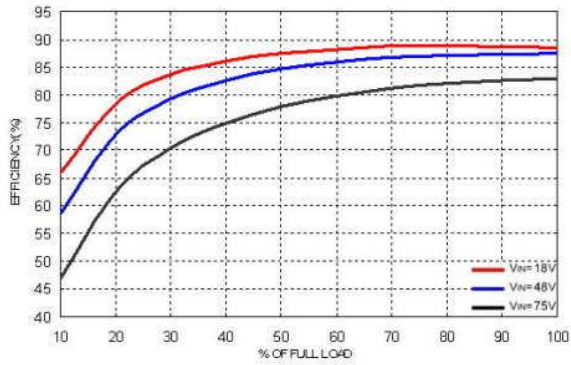

Efficiency Versus Output Current

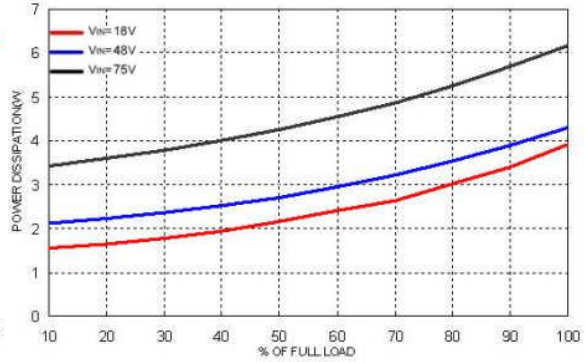

Power Dissipation Versus Output Current

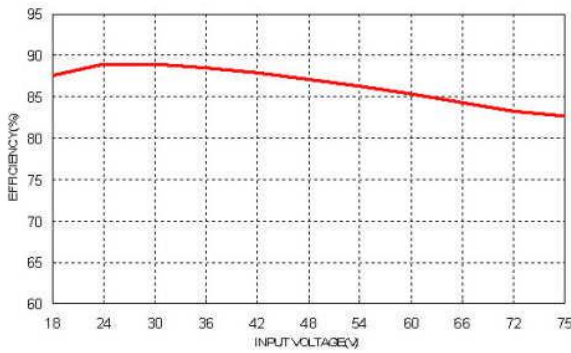

Efficiency Versus Input Voltage. Full Load

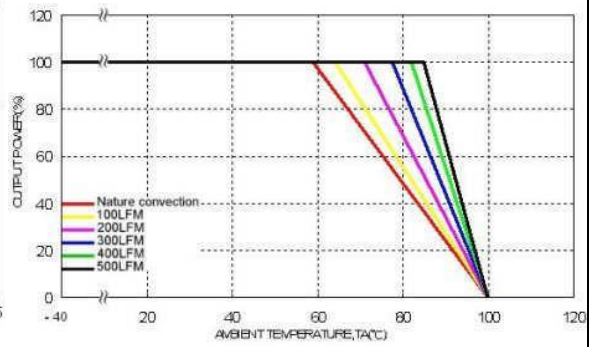

Derating Output Current Versus Ambient Temperature and Airflow Vin=Vin(nom)

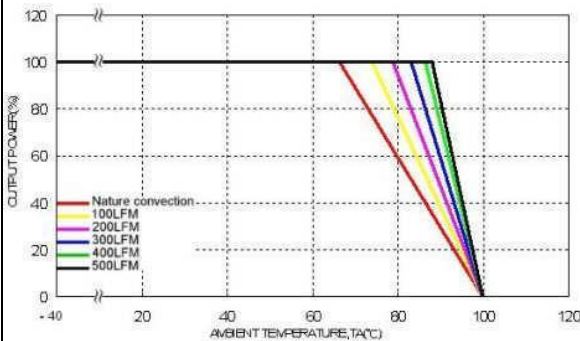

Derating Output Current Versus Ambient Temperature with Heat-Sink and Airflow, Vin = Vin(nom)

Characteristic Curves (Continued)

All test conditions are at 25°C. The figures are for PXE30-48WS15

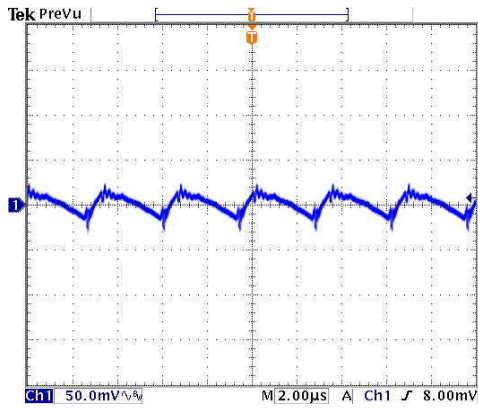

Typical Output Ripple and Noise.  
Vin=Vin(nom), Full Load

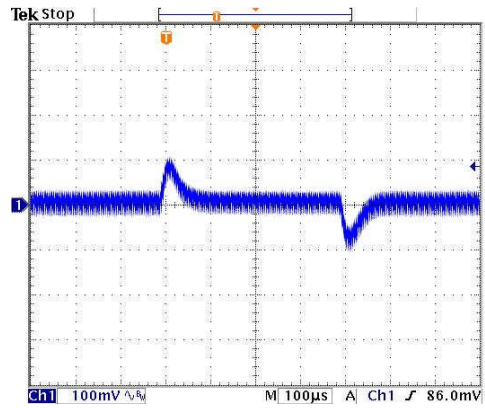

Transient Response to Dynamic Load Change from 100% to 75% to 100% of Full Load ; Vin=Vin(nom)

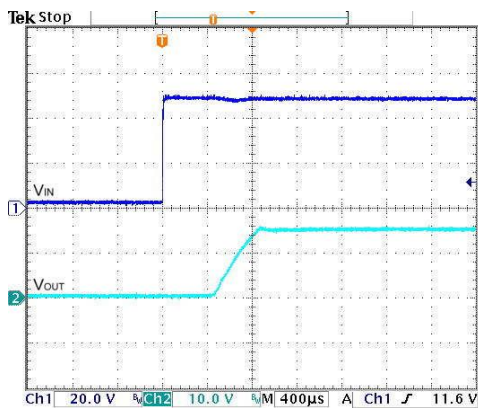

Typical Input Start-Up and Output Rise Characteristic  
Vin=Vin(nom), Full Load

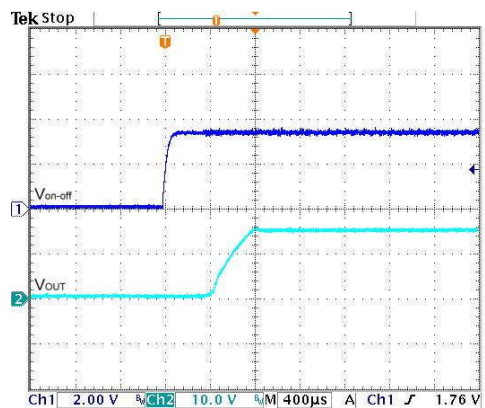

Using ON/OFF Voltage Start-Up and Vo Rise Characteristic  
Vin=Vin(nom), Full Load

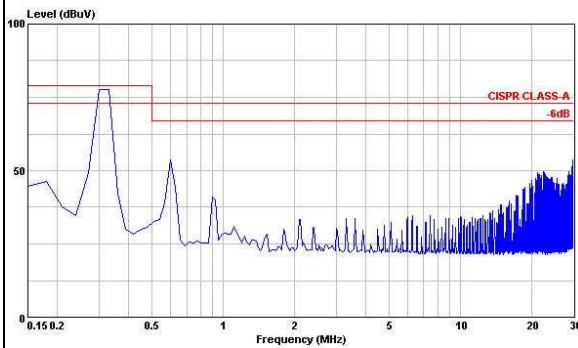

Conduction Emission of EN55022 Class A  
Vin=Vin(nom), Full Load

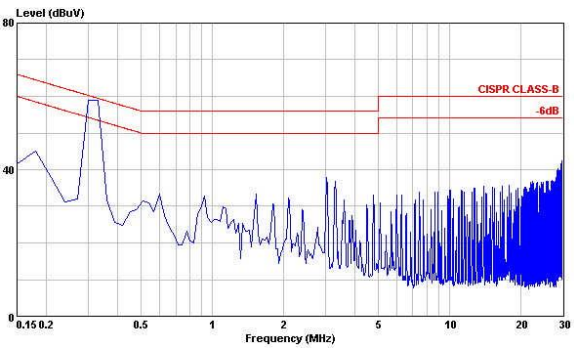

Conduction Emission of EN55022 Class B  
Vin=Vin(nom), Full Load



Test Configurations

Input reflected-ripple current measurement test:

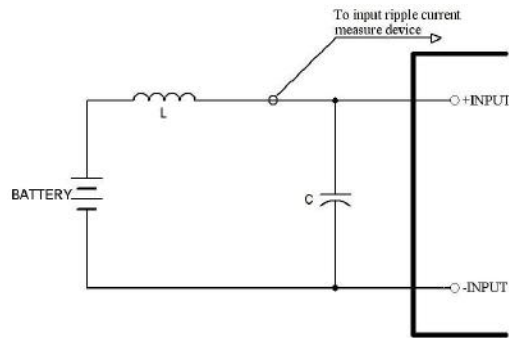

Component	Value	Voltage	Reference
L	12μH	---	---
C	220μF	100V	Aluminum Electrolytic Capacitor

Peak-to-peak output ripple & noise measurement test:

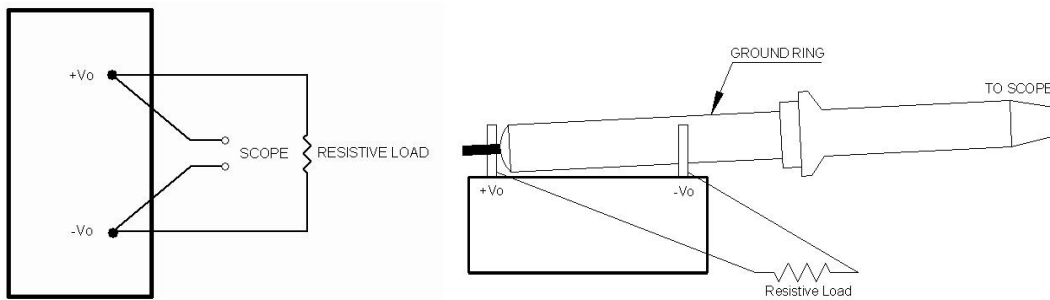

Output voltage and efficiency measurement test:

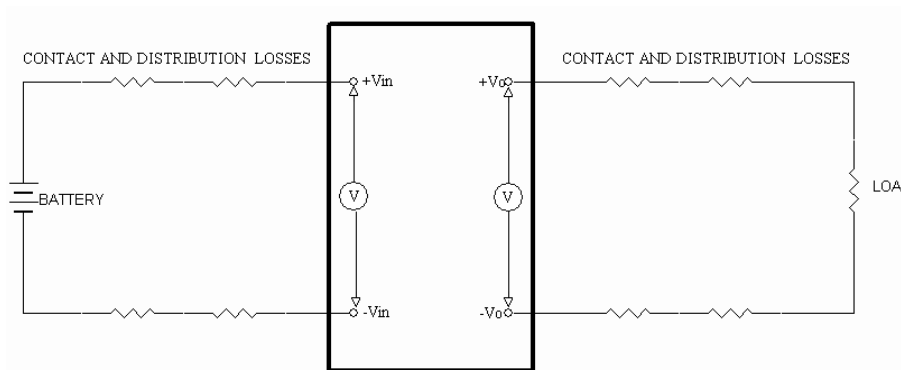

Note: All measurements are taken at the module terminals.

$$Efficiency = \left( \frac{V_o \times I_o}{V_{in} \times I_{in}} \right) \times 100\%$$

EMC Considerations

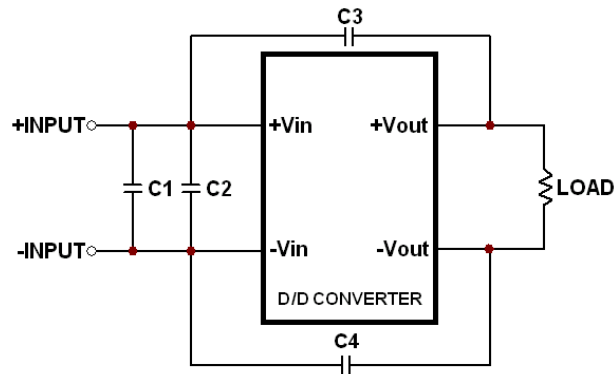

Suggested Schematic for EN55022 Conducted Emission Class A Limits

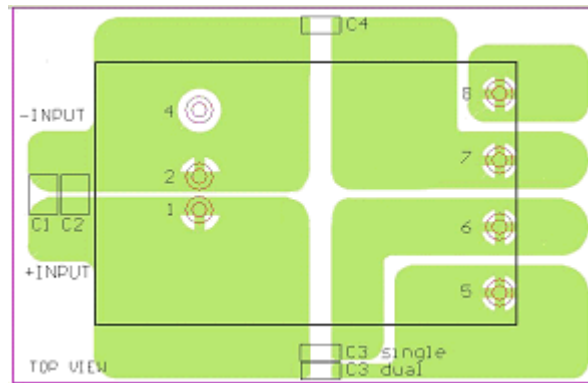

Recommended Layout with Input Filter

To meet conducted emissions EN55022 CLASS A needed the following components:

PXE30-24WSxx

Component	Value	Voltage	Reference
C1	6.8uF	50V	1812 MLCC
C3,C4	1000pF	2KV	1808 MLCC

PXE30-48WSxx

Component	Value	Voltage	Reference
C1,C2	2.2uF	100V	1812 MLCC
C3,C4	1000pF	2KV	1808 MLCC

EMC Considerations (Continued)

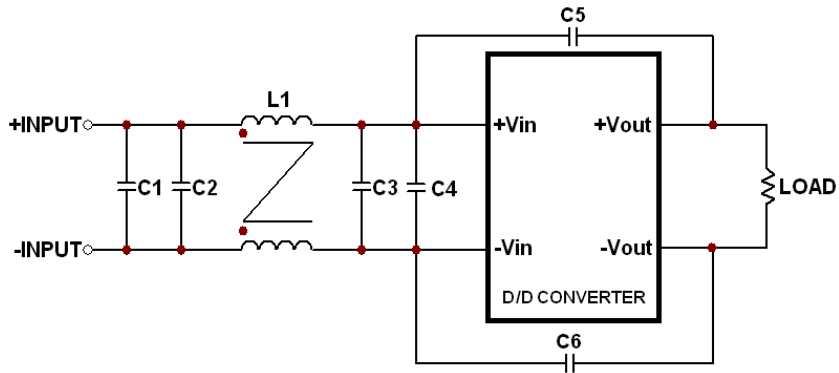

Suggested Schematic for EN55022 Conducted Emission Class B Limits

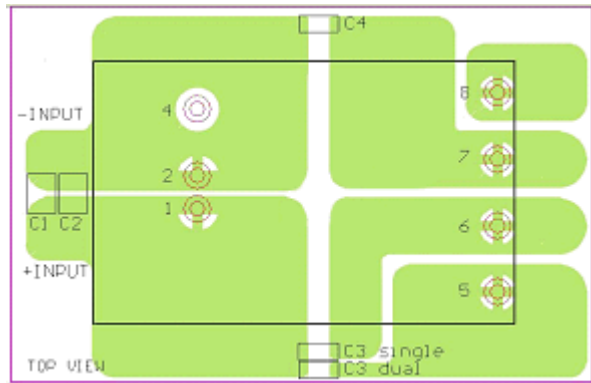

Recommended Layout with Input Filter

To meet conducted emissions EN55022 CLASS B needed the following components:

PXE30-24WSxx

Component	Value	Voltage	Reference
C1,C3	6.8uF	50V	1812 MLCC
C5,C6	1000pF	2KV	1808 MLCC
L1	450uH	----	Common Choke

PXE30-48WSxx

Component	Value	Voltage	Reference
C1,C2	2.2uF	100V	1812 MLCC
C3,C4	2.2uF	100V	1812 MLCC
C5,C6	1000pF	2KV	1808 MLCC
L1	450uH	----	Common Choke

## EMC Considerations (Continued)

Common Choke L1 is defined as follows:

- L:450 $\mu$ H $\pm$ 35% / DCR:25m $\Omega$ , max
- A height: 9.8 mm, Max
- All dimensions in millimeters

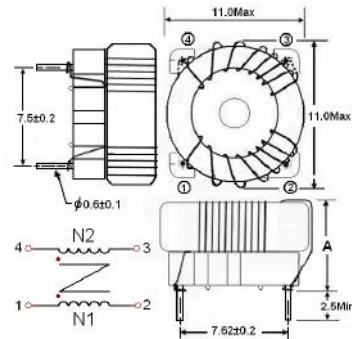

## Input Source Impedance

The converter should be connected to a low impedance input source. Highly inductive source impedance can affect the stability of the converter. Input external L-C filter is recommended to minimize input reflected ripple current. The inductor has a simulated source impedance of 12 $\mu$ H and the capacitor is Nippon chemi-con KY series 220 $\mu$ F/100V. The capacitor must be located as close as possible to the input terminals of the converter for lowest impedance.

## Output Over Current Protection

When excessive output currents occur in the system, circuit protection is required on all converters. Normally, overload current is maintained at approximately 150 percent of rated current for PXF40-xxSxx series.

Hiccup-mode is a method of operation in a converter whose purpose is to protect the power supply from being damaged during an over-current fault condition. It also enables the converter to restart when the fault is removed. There are other ways of protecting the converter when it is over-loaded, such as the maximum current limiting or current foldback methods.

One of the problems resulting from over current is that excessive heat may be generated in power devices; especially MOSFET and Schottky diodes and the temperature of these devices may exceed their specified limits. A protection mechanism has to be used to prevent these power devices from being damaged.

The operation of hiccup is as follows. When the current sense circuit sees an over-current event, the controller shuts off the converter for a given time and then tries to start up the converter again. If the over-load condition has been removed, the converter will start up and operate normally; otherwise, the controller will see another over-current event and will shut off the converter again, repeating the previous cycle. Hiccup operation has none of the drawbacks of the other two protection methods, although its circuit is more complicated because it requires a timing circuit. The excess heat due to overload lasts for only a short duration in the hiccup cycle, hence the junction temperature of the power devices is much lower.

### Output Over Voltage Protection

The output over-voltage protection consists of an output Zener diode that monitors the voltage on the output terminals. If the voltage on the output terminals exceeds the over-voltage protection threshold, then the Zener diode clamps the output voltage.

### Short Circuitry Protection

Continuous, hiccup and auto-recovery mode.

During a short circuit condition the converter will shut down. The average current during this condition will be very low.

### Thermal Consideration

The converter operates in a variety of thermal environments. However, sufficient cooling should be provided to help ensure reliable operation of the unit. Heat is removed by conduction, convection, and radiation to the surrounding environment. Proper cooling can be verified by measuring the point as shown in the figure below. The temperature at this location should not exceed 100°C. When operating, adequate cooling must be provided to maintain the test point temperature at or below 100°C. Although the maximum point temperature of the converter is 100°C, limiting this temperature to a lower value will yield higher reliability.

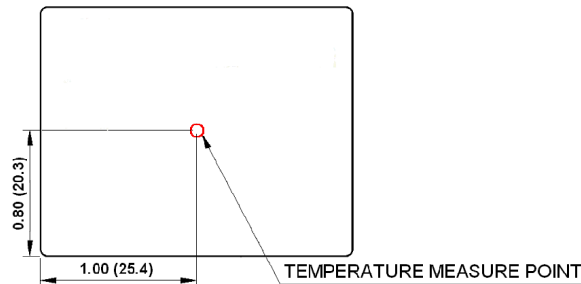

### Heat Sink Consideration

Use heat-sink (7G-0011C-F) for lowering temperature and higher reliability of the module..

All dimensions in millimeters

Remote ON/OFF Control

The Remote ON/OFF Pin is used to turn on and off the DC-DC converter. The user must use a switch to control the logic voltage (high or low level) of the ON/OFF pin, referenced to  $-V_i$ . The switch can be open collector transistor, FET or Opto-Coupler that is capable of sinking up to 0.5 mA at low-level logic Voltage. High-level logic of the ON/OFF signal (maximum voltage): the allowable leakage current of the switch at 12V is 0.5mA.

Remote ON/OFF Implementation Circuits

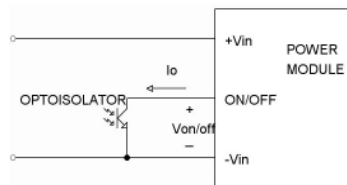

Isolated-Control Remote ON/OFF

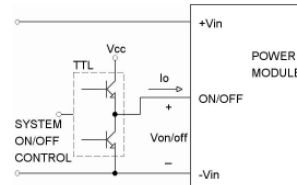

Level Control Using TTL Output

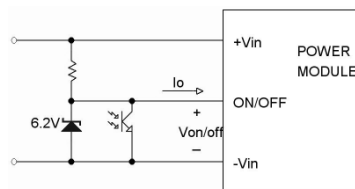

Level Control Using Line Voltage

There are two remote control options available, Positive Logic and Negative Logic.

a. Positive logic:

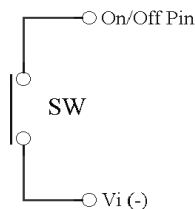

PXE30-xxWSxx module is turned off using Low-level logic

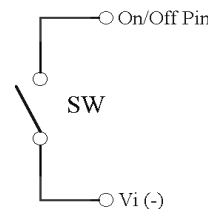

PXE30-xxWSxx module is turned on using High-level logic

b. Negative logic:

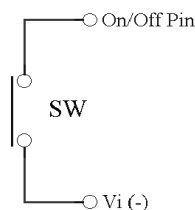

PXE30-xxWSxx module is turned on using Low-level logic

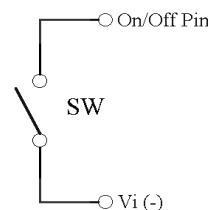

PXE30-xxWSxx module is turned off using High-level logic

Mechanical Data

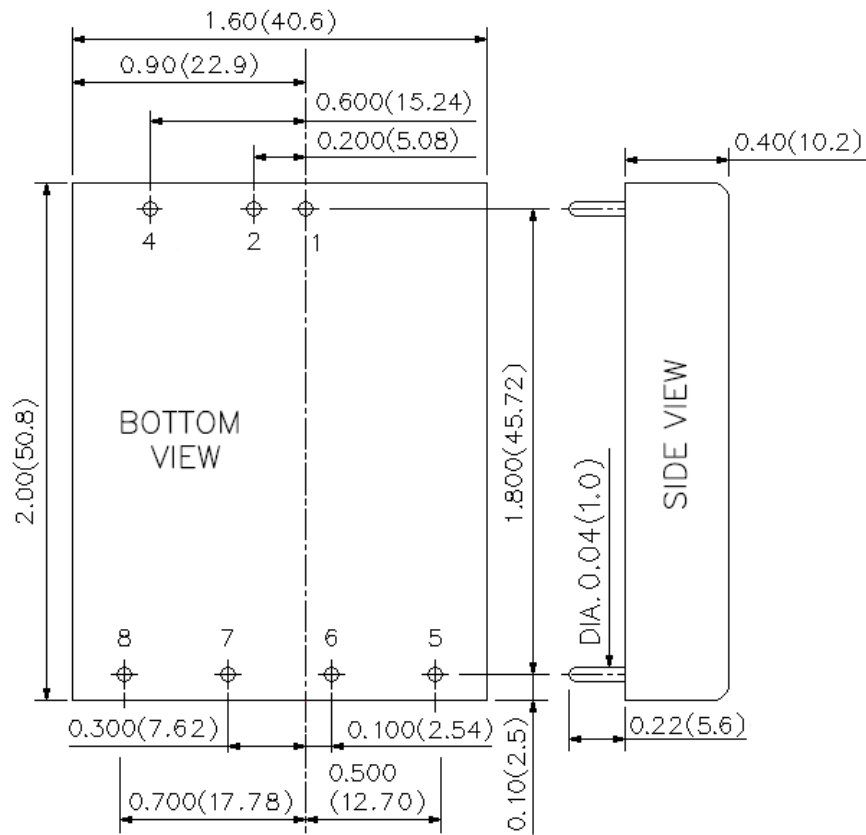

PIN CONNECTION	
PIN	FUNCTION
1	+INPUT
2	-INPUT
4	CTRL
5	NO PIN
6	+OUTPUT
7	-OUTPUT
8	TRIM

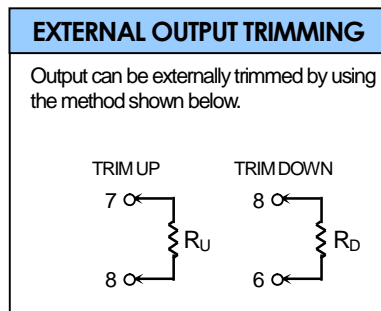



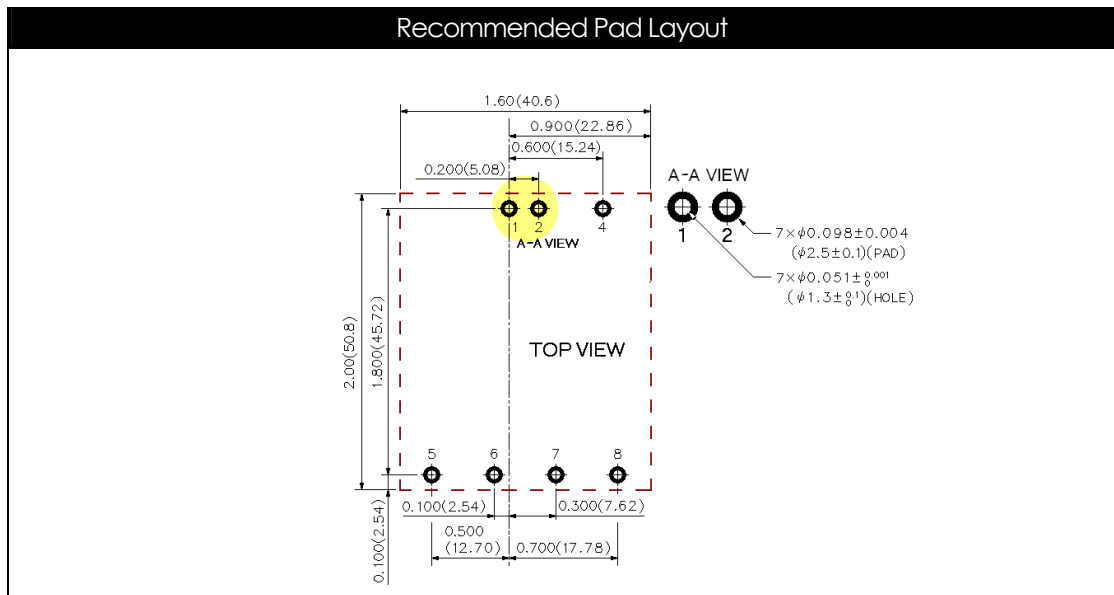

Output Voltage Adjustment

Output voltage set point adjustment allows the user to increase or decrease the output voltage set point of a module. This is accomplished by connecting an external resistor between the TRIM pin and either the Vo(+) or Vo(-) pins. With an external resistor between the TRIM and Vo(-) pin, the output voltage set point increases. With an external resistor between the TRIM and Vo(+) pin, the output voltage set point decreases.

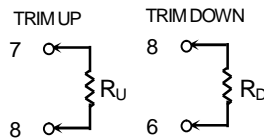

TRIM TABLE

PXE30-xxWS1P5

Trim up (%)	1	2	3	4	5	6	7	8	9	10
V <sub>OUT</sub> (Volts)=	1.515	1.53	1.545	1.56	1.575	1.59	1.605	1.62	1.635	1.65
R <sub>U</sub> (K Ohms)=	4.578	2.605	1.227	0.808	0.557	0.389	0.27	0.18	0.11	0.054
Trim down (%)	1	2	3	4	5	6	7	8	9	10
V <sub>OUT</sub> (Volts)=	1.485	1.47	1.455	1.44	1.425	1.41	1.395	1.38	1.365	1.35
R <sub>D</sub> (K Ohms)=	5.704	2.571	1.527	1.005	0.692	0.483	0.334	0.222	0.135	0.065

PXE30-xxWS1P8

Trim up (%)	1	2	3	4	5	6	7	8	9	10
V <sub>OUT</sub> (Volts)=	1.818	1.836	1.854	1.872	1.89	1.908	1.926	1.944	1.962	1.98
R <sub>U</sub> (K Ohms)=	11.639	5.205	3.06	1.988	1.344	0.915	0.609	0.379	0.2	0.057
Trim down (%)	1	2	3	4	5	6	7	8	9	10
V <sub>OUT</sub> (Volts)=	1.782	1.764	1.746	1.728	1.71	1.692	1.674	1.656	1.638	1.62
R <sub>D</sub> (K Ohms)=	14.66	6.57	3.874	2.525	1.716	1.177	0.792	0.503	0.278	0.098

PXE30-xxWS2P5

Trim up (%)	1	2	3	4	5	6	7	8	9	10
V <sub>OUT</sub> (Volts)=	2.525	2.55	2.575	2.6	2.625	2.65	2.675	2.7	2.725	2.75
R <sub>U</sub> (K Ohms)=	37.076	16.675	9.874	6.474	4.434	3.074	2.102	1.374	0.807	0.354
Trim down (%)	1	2	3	4	5	6	7	8	9	10
V <sub>OUT</sub> (Volts)=	2.475	2.45	2.425	2.4	2.375	2.35	2.325	2.3	2.275	2.25
R <sub>D</sub> (K Ohms)=	49.641	22.481	13.428	8.902	6.186	4.375	3.082	2.112	1.358	0.754

PXE30-xxWS3P3

Trim up (%)	1	2	3	4	5	6	7	8	9	10
V <sub>OUT</sub> (Volts)=	3.333	3.366	3.399	3.432	3.465	3.498	3.531	3.564	3.597	3.630
R <sub>U</sub> (K Ohms)=	57.930	26.165	15.577	10.283	7.106	4.988	3.476	2.341	1.459	0.753
Trim down (%)	1	2	3	4	5	6	7	8	9	10
V <sub>OUT</sub> (Volts)=	3.267	3.234	3.201	3.168	3.135	3.102	3.069	3.036	3.003	2.970
R <sub>D</sub> (K Ohms)=	69.470	31.235	18.490	12.117	8.294	5.745	3.924	2.559	1.497	0.647

## Output Voltage Adjustment(Continued)

## PXE30-xxWS05

Trim up (%)	1	2	3	4	5	6	7	8	9	10
V <sub>OUT</sub> (Volts)=	5.050	5.100	5.150	5.200	5.250	5.300	5.350	5.400	5.450	5.500
R <sub>U</sub> (K Ohms)=	36.570	16.580	9.917	6.585	4.586	3.253	2.302	1.588	1.032	0.588
Trim down (%)	1	2	3	4	5	6	7	8	9	10
V <sub>OUT</sub> (Volts)=	4.950	4.900	4.850	4.800	4.750	4.700	4.650	4.600	4.550	4.500
R <sub>D</sub> (K Ohms)=	45.533	20.612	12.306	8.152	5.660	3.999	2.812	1.922	1.230	0.676

## PXE30-xxWS12

Trim up (%)	1	2	3	4	5	6	7	8	9	10
V <sub>OUT</sub> (Volts)=	12.120	12.240	12.360	12.480	12.600	12.720	12.840	12.960	13.080	13.200
R <sub>U</sub> (K Ohms)=	367.910	165.950	98.636	64.977	44.782	31.318	21.701	14.488	8.879	4.391
Trim down (%)	1	2	3	4	5	6	7	8	9	10
V <sub>OUT</sub> (Volts)=	11.880	11.760	11.640	11.520	11.400	11.280	11.160	11.040	10.920	10.800
R <sub>D</sub> (K Ohms)=	460.990	207.950	123.600	81.423	56.118	39.249	27.199	18.162	11.132	5.509

## PXE30-xxWS15

Trim up (%)	1	2	3	4	5	6	7	8	9	10
V <sub>OUT</sub> (Volts)=	15.150	15.300	15.450	15.600	15.750	15.900	16.050	16.200	16.350	16.500
R <sub>U</sub> (K Ohms)=	404.180	180.590	106.060	68.796	46.437	31.531	20.883	12.898	6.687	1.718
Trim down (%)	1	2	3	4	5	6	7	8	9	10
V <sub>OUT</sub> (Volts)=	14.850	14.700	14.550	14.400	14.250	14.100	13.950	13.800	13.650	13.500
R <sub>D</sub> (K Ohms)=	499.820	223.410	131.270	85.204	57.563	39.136	25.974	16.102	8.424	2.282

Soldering and Reflow Consideration

Lead free wave solder profile for PXE30-xxWSxx DIP type

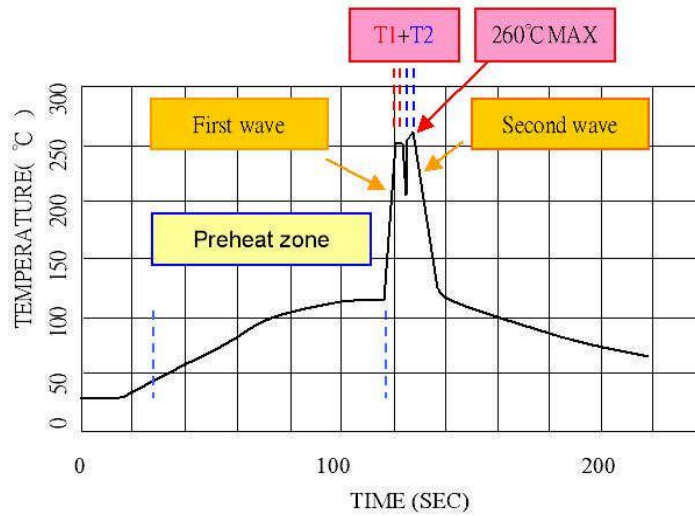

Zone	Reference Parameter
Preheat zone	Rise temp. speed : 3°C / sec max. Preheat temp. : 100~130°C
Actual heating	Peak temp. : 250~260°C Peak time (T1+T2 time) : 4~6 sec

**Reference Solder:** Sn-Ag-Cu/Sn-Cu

**Hand Welding:** Soldering iron-Power 90W

Welding Time: 2-4 sec

Temp.: 380-400 °C

Packaging Information

12 PCS per TUBE

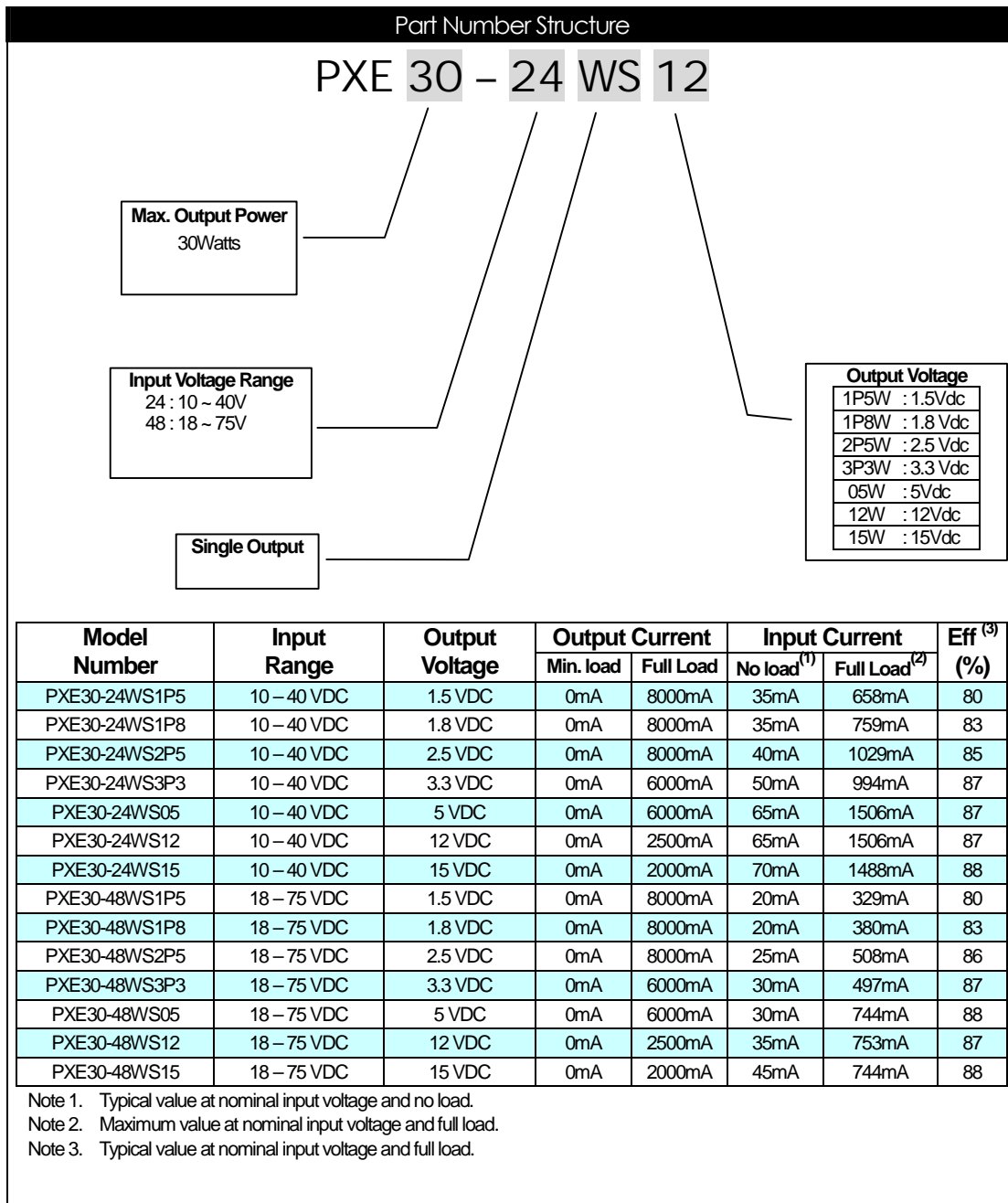

**Safety and Installation Instruction****Fusing Consideration**

Caution: This converter is not internally fused. An input line fuse must always be used.

This encapsulated converter can be used in a wide variety of applications, ranging from simple stand-alone operation to an integrated part of sophisticated power architecture. For maximum flexibility, internal fusing is not included; however, to achieve maximum safety and system protection, always use an input line fuse. The safety agencies require a slow-blow fuse with maximum rating of 6A. Based on the information provided in this data sheet on inrush energy and maximum DC input current; the same type of fuse with lower rating can be used. Refer to the fuse manufacturer's data for further information.

**MTBF and Reliability****The MTBF of PXE30-xxWSxx DC/DC converter has been calculated using**

Bellcore TR-NWT-000332 Case I: 50% stress, Operating Temperature at 40°C (Ground fixed and controlled environment ). The resulting figure for MTBF is  $1.315 \times 10^6$  hours.

MIL-HDBK-217F NOTICE2 FULL LOAD, Operating Temperature at 25°C °C. The resulting figure for MTBF is  $3.456 \times 10^5$  hours.