

Powering
Your Innovation

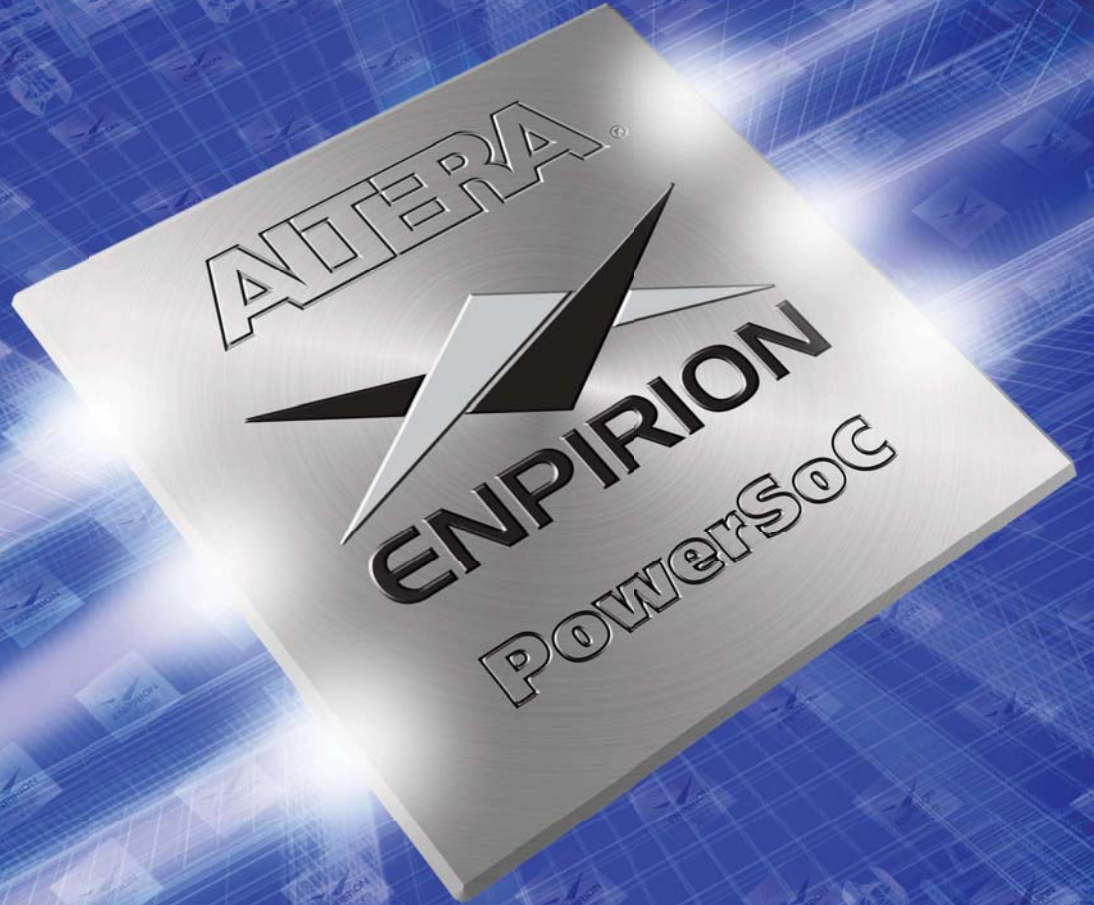

ATERA[®]
MEASURABLE ADVANTAGE™

Powering Your Innovation – PowerSoC

Key Intellectual Property

High-frequency power conversion
Magnetics engineering
Power packaging and construction

Integrated Power Management Systems

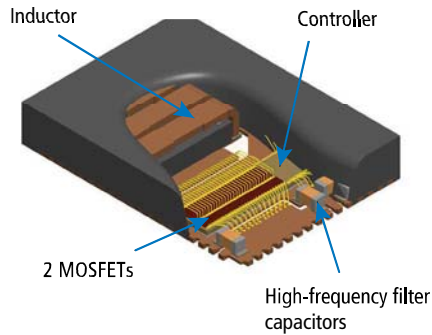

Engineered Turnkey Solutions

Fully simulated, characterized, and validated
System-level qualified
Eliminates inductor and capacitor selection

PowerSoC Comparison



PowerSoC – 25% to 50% smaller footprint than alternative solutions:

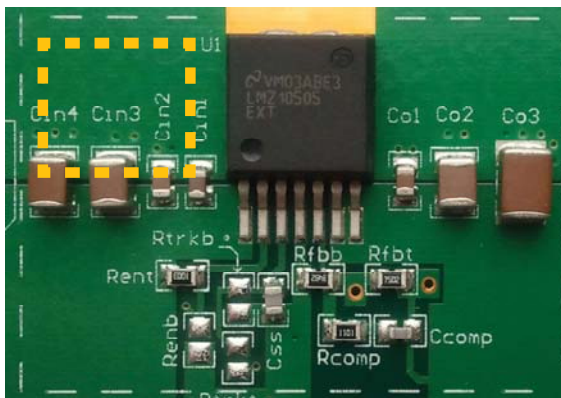

Competitors' Modules

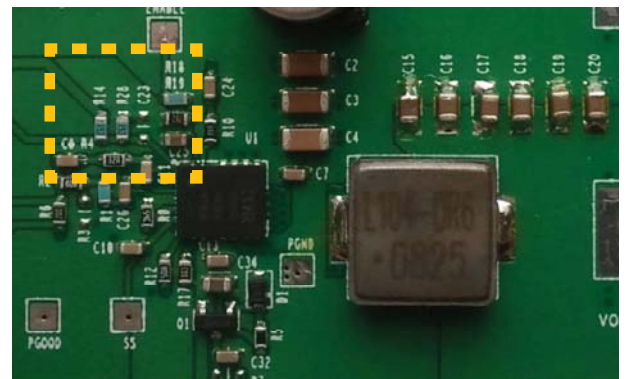

Competitors' Discrete Regulators

Benefits of PowerSoC

Addressing today's and tomorrow's system power design challenges:

Highest Power Density and Smallest Footprint

Greatly minimizes the amount of PCB space and height profile required for point-of-load regulation compared to alternative discrete switching regulators and modules.

High Efficiency and Thermal Performance

Optimized with up to 96 percent efficiency. High-efficiency devices are industrial graded, with most products not requiring load de-rating or air flow at 85° C ambient temperature.

Lowest Component Count and Higher Reliability

PowerSoCs are specified, simulated, characterized, validated, and manufacturing-tested as a complete power system. Fewer components and tightly controlled IC manufacturing processes permit an unsurpassed 45,000-year MTBF reliability.

Ease of Design and Fastest Time to Market

PowerSoCs with integrated inductor and compensation enable turnkey designs. Development requires fewer design steps with significantly less exposure to design iteration versus discrete switching regulators.

Fully Validated Power Solutions

Fully validated PCB layout and design files enable customers nearly 100 percent first-pass success.

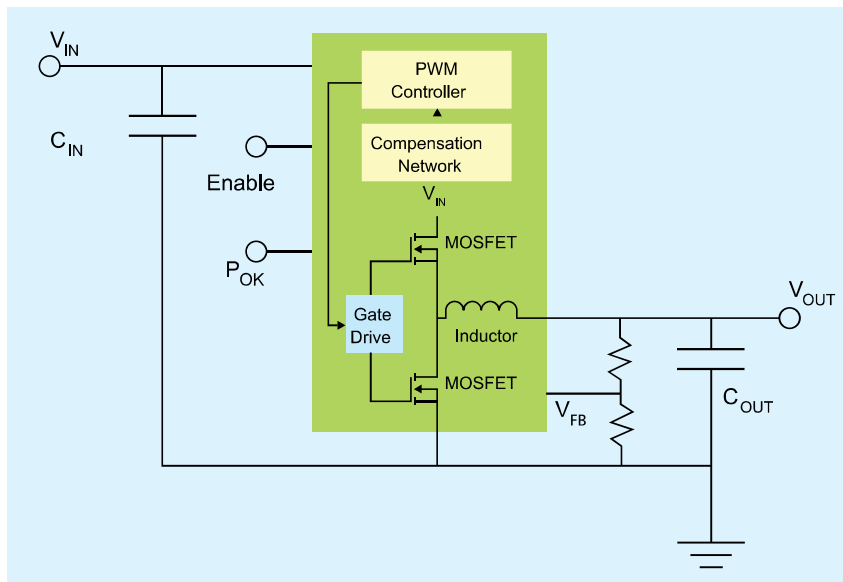

Take A Closer Look

Low Radiated Noise

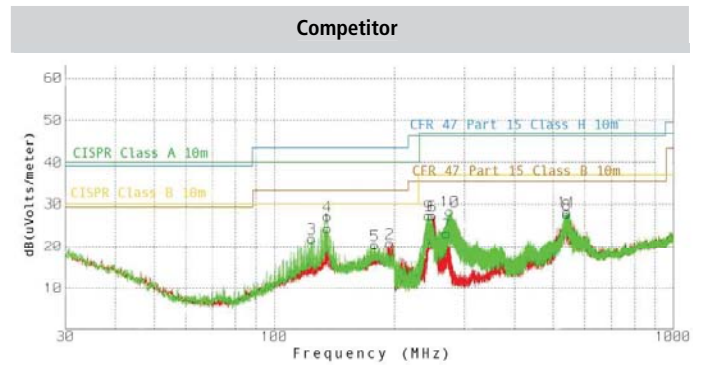
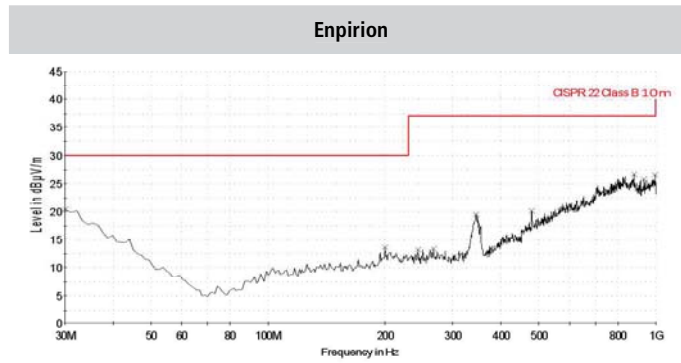

Low Ripple

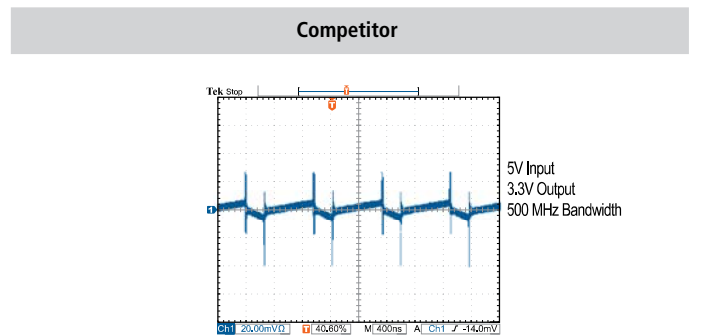
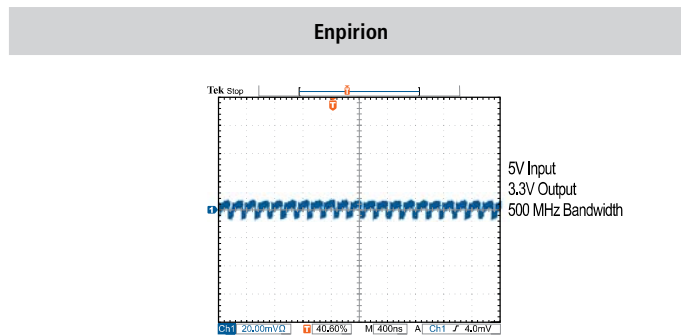

Fast Dynamic Response

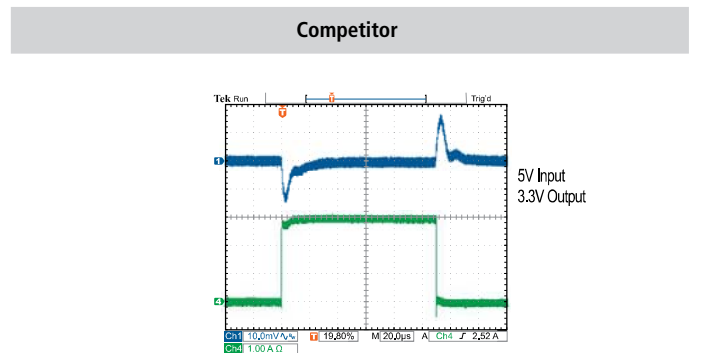
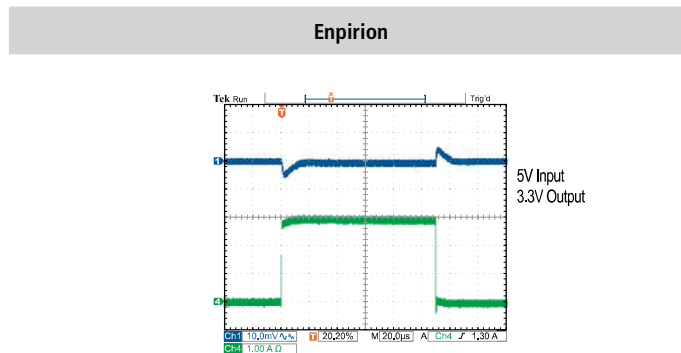

Applications

Market pressures are driving equipment manufacturers to add more features, functionality, and higher bandwidth while moving to smaller form factors and targeting improved energy efficiency. The newest 28 nm and 20 nm FPGAs, processors, and other SoCs address these challenges, in part, by implementing more granular and precise levels of power management. The result is an escalating number of power rails, complex power-up sequencing requirements, and tighter noise tolerances. Enpirion® power solutions from Altera meet these power design challenges and are broadly used in many applications.

Computer



- Server motherboards
- NIC and HBA cards
- RAID controllers
- Micro servers

Networking and Telecommunications



- Radio basestation (macro, pico, femto)
- Backhaul (microwave, wireline)
- Media gateway (ATCA/AMC)

Industrial and Embedded



- Security systems/digital video recorder (DVR)
- Industrial computing
- Industrial communication modules

Enterprise Storage



- Solid State Drives (SSD):
SATA, SAS, mSATA, PCI Express® (PCIe®)
- Storage systems

Test and Measurement



- Network analyzers
- Automated test equipment (ATE)
- Data acquisition
- Scopes, analyzers, signal generators

Optical Networking



- Optical Modules:
SFP, XFP, CXP, CFP
- Active optical cable
- Reprogrammable add/drop mux

400 mA
2x1.75 mm

600 mA
2.5x2.25 mm

600–1500 mA
3x3 mm

1.5–3 A
6x4 mm

3–4 A
7x4 mm

4–9 A
11x8 mm

9–12 A
10x11 mm

15 A
13x12 mm

Smallest Solution Footprint

(Shown actual package size)

Featured PowerSoC Products

Part Number	I _{OUT} (A)	V _{IN} (VDC)	V _{OUT} Range (VDC) ¹	Pkg (pins)	Pkg Size (mm)			Solution Size (mm ²)	Ext. Components	XFB V Adjust	VID V Adjust	Power Good	Program Soft Start	Margining	Input Sync	Output Sync	Parallel Capability	Light Load Mode
					L	W	H											
5300 5 V Step-Down Converters																		
EP5348UI	0.4	2.5	– 5.5	0.60 – Note 1	uQFN14	2.0	1.75	0.9	21	6	•							
EP535[x]HUI ²	0.6	2.4	– 5.5	1.80 – 3.3	uQFN16	2.5	2.25	1.1	14	2		3-pin						•
EP535[x]LUI ²	0.6	2.4	– 5.5	0.60 – Note 1	uQFN16	2.5	2.25	1.1	14	2	•	3-pin						•
EP53A[x]HQI ²	1.0	2.4	– 5.5	1.80 – 3.3	QFN16	3.0	3.0	1.1	21	3		3-pin						•
EP53A[x]LQI ²	1.0	2.4	– 5.5	0.60 – Note 1	QFN16	3.0	3.0	1.1	21	3	•	3-pin						•
EP53F8QI	1.5	2.4	– 5.5	0.60 – Note 1	QFN16	3.0	3.0	1.1	40	8	•		•					
EN5319QI	1.5	2.4	– 5.5	0.60 – Note 1	QFN24	4.0	6.0	1.1	55	6	•		•					
EN5329QI	2.0	2.4	– 5.5	0.60 – Note 1	QFN24	4.0	6.0	1.1	55	6	•		•					
EN5339QI	3.0	2.4	– 5.5	0.60 – Note 1	QFN24	4.0	6.0	1.1	55	7	•		•					
EN5364QI	6.0	2.4	– 6.6	0.60 – Note 1	QFN68	8.0	11.0	1.85	160	6	•		•	•	•	•	•	•
EN5367QI	6.0	2.5	– 5.5	0.60 – Note 1	QFN54	10.0	5.5	3.0	160	12	•		•	•		•		
EN5394QI	9.0	2.4	– 6.6	0.60 – Note 1	QFN68	8.0	11.0	1.85	190	7	•		•	•	•	•	•	
6300 Efficiency-Optimized Step-Down DC-DC Converters																		
EN6310QI	1.0	2.7	– 5.5	0.60 – 3.3	QFN30	4.0	5.0	1.85	65	10	•		•	•				
EN6337QI	3.0	2.5	– 6.6	0.75 – Note 1	QFN38	4.0	7.0	1.85	75	6	•		•	•		•		•
EN6347QI	4.0	2.5	– 6.6	0.75 – Note 1	QFN38	4.0	7.0	1.85	75	6	•		•	•		•		•
EN6360QI	8.0	2.5	– 6.6	0.60 – Note 1	QFN68	8.0	11.0	3.0	190	10	•		•	•		•	•	
EN63A0QI	12.0	2.5	– 6.6	0.60 – Note 1	QFN76	10.0	11.0	3.0	225	11	•		•	•		•	•	
2300 12 V Step-Down Converters																		
EN2342QI	4.0	4.5	– 14.0	0.75 – 5.0	QFN68	8.0	11.0	3.0	200	15	•		•	•		•	•	
EN2360QI	6.0	4.5	– 14.0	0.75 – 5.0	QFN68	8.0	11.0	3.0	200	13	•		•	•		•	•	
EN2392QI	9.0	4.5	– 13.2	0.75 – 3.3	QFN76	10.0	11.0	3.0	235	17	•		•	•		•	•	•
EN23F2QI	15.0	4.5	– 13.2	0.75 – 3.3	QFN92	13.0	12.0	3.0	325	19	•		•	•		•	•	•
EV1300 Source/Sink DDR VTT Converters																		
EV1320QI	2.0	1.0	– 1.8	0.50 – 0.9	QFN16	3.0	3.0	0.55	40	6			•	•				•
EV1340QI	5.0	1.0	– 1.8	0.50 – 0.9	QFN54	5.5	10.0	3.0	125	14	•		•	•				•
EV1380QI	8.0	1.16	– 1.8	0.60 – 0.9	QFN68	8.0	11.0	3.0	200	14	•		•	•				•

Notes

- Maximum $V_{OUT} = V_{IN} - V_{DROPOUT}$ where $V_{DROPOUT} = R_{DROPOUT} \times \text{Load Current}$. Reference device datasheet to calculate $V_{DROPOUT}$. Typical $V_{DROPOUT} = 0.4V$.
- [x] = "8" for PWM only; "7" for Light Load mode

Definitions

- Qualified to industrial (I) ambient temperature range: -40°C to +85°C
- VID = Output voltage programming using Voltage ID code pins
- Margining = The ability to force V_{OUT} out of regulation by a selectable percentage (via 2 pins)
- Input/Output Sync = ability to control frequency of the regulator(s) to reduce input/output voltage ripple
- Size estimate for single-sided PCB including all suggested external components

For a complete list of Enpirion power products, please visit www.altera.com/devices/power/power-index.html

Powering Your FPGA Innovation

Featured Products for FPGA Applications

Altera offers a range of verified power solutions that cover FPGA power requirements.

Max I _{LOAD} (A)	Solution	Description	V _{IN} Range (V)	V _{OUT} Range (V) ¹	Core Power ²	Low Noise ³
160	EC7401QI and ET4040QI	4-phase pulse-width modulation (PWM) controller and 40A powertrain	4.5 – 14	0.6 – 5.0	•	
40	ED8101P0xQI and ET4040QI	Single-phase digital controller with PMBus and 40A powertrain	4.5 – 14	0.6 – 5.0	•	
40	ED8106N0xQI and ET4040QI	Single-phase digital controller and 40A powertrain	4.5 – 14	0.6 – 5.0	•	
15	EN23F2QI	15A PowerSoC, parallel capability	4.5 – 13.2	0.75 – 3.3	•	•
12	EN63A0QI	High-efficiency 12A PowerSoC, parallel capability	2.5 – 6.6	0.6 – V _{IN} - V _{DROPOUT}	•	•
9	EN2392QI	9A PowerSoC, parallel capability	4.5 – 13.2	0.75 – 3.3	•	•
8	EN6360QI	High-efficiency 8A PowerSoC, parallel capability	2.5 – 6.6	0.6 – V _{IN} - V _{DROPOUT}	•	•
6	EN2360QI	6A PowerSoC, pin compatible with EN2342QI	4.5 – 14	0.75 – 5.0	•	•
6	EN5367QI	6A PowerSoC	2.5 – 5.5	0.6 – V _{IN} - V _{DROPOUT}		•
4	EN2342QI	4A PowerSoC, pin compatible with EN2360QI	4.5 – 14	0.75 – 5.0	•	•
4	EN6347QI	High-efficiency 4A PowerSoC	2.5 – 6.6	0.75 – V _{IN} - V _{DROPOUT}	•	•
3	EN6337QI	High-efficiency 3A PowerSoC	2.5 – 6.6	0.75 – V _{IN} - V _{DROPOUT}	•	•
3	EN5339QI	3A PowerSoC; pin compatible with EN5329/19QI	2.4 – 5.5	0.6 – V _{IN} - V _{DROPOUT}		•
2	ER2120QI	2A switching regulator with integrated MOSFETs	5.0 – 14	0.6 – 12	•	
2	EN5329QI	2A PowerSoC; pin compatible with EN5339/19QI	2.4 – 5.5	0.6 – V _{IN} - V _{DROPOUT}		•
1.5	EN5319QI	1.5A PowerSoC; pin compatible with EN5339/29QI	2.4 – 5.5	0.6 – V _{IN} - V _{DROPOUT}		•
1	ER3110DI	1A switching regulator with integrated MOSFETs	3.0 – 36	0.6 – 12	•	
1	EN6310QI	High-efficiency 1A PowerSoC	2.7 – 5.5	0.6 – 3.3	•	•
1	EP53A8xQI	Ultra small 1A PowerSoC	2.4 – 5.5	0.6 – V _{IN} - V _{DROPOUT}		•
1	EY1501DI	1A linear regulator	2.2 – 6	0.8 – 5	•	•
0.6	EP5358xQI	Ultra small 0.6A PowerSoC	2.4 – 5.5	0.6 – V _{IN} - V _{DROPOUT}		•
0.5	ER3105QI	0.5A switching regulator with integrated MOSFETs	3.0 – 36	0.6 – 34	•	
0.15	EY1603TI	150mA low IQ linear regulator	6.0 – 40	2.5 – 12	•	•
0.05	EY1602SI	50mA low IQ linear regulator	6.0 – 40	2.5 – 12	•	•

Special Function Products

Product	Description
ES1010QI	12V power distribution hot swap controller
ES1022QI	Sequencer with 4 delay adjustable sequenced outputs with input voltage monitoring
ES1020QI	Sequencer with 4 delay adjustable sequenced outputs with input voltage monitoring; supplies gate drive for external FETs
ES1021QI	Sequencer with 4 delay adjustable sequenced outputs with input voltage monitoring; supplies gate drive for external FETs; groups 4 channels into 2 groups each with their own enable

Notes

1. Reference device datasheet for V_{DROPOUT} value
2. Meets accuracy, ripple, and transient requirements for FPGA core rails.
3. Low-output voltage ripple and meets CISPR 22 Class B emissions standard.

Altera Corporation
101 Innovation Drive
San Jose, CA 95134
USA
www.altera.com

NJ Technology Center
Perryville III
53 Frontage Road, Suite 210
Hampton, NJ 08827
Phone: +1.908.894.6000
Fax: +1.908.894.6090
www.altera.com/enpirion

For more information on Enpirion products,
contact **enpirionpower@altera.com**

