



EMpro - multi-functional energy measuring devices for front panel installation

User manual

User manual

EMpro - multi-functional energy measuring devices for front panel installation

UM EN EMpro front panel, Revision 00

2020-03-05

This user manual is valid for:

Designation	Order No.
EEM-MA770	2907945
EEM-MA771	2908286
EEM-MA770-R	2907944
EEM-MA771-R	2908285
EEM-MA770-PN	2907946
EEM-MA771-PN	2908301
EEM-MA770-EIP	2907953
EEM-MA771-EIP	2908302

Table of contents

1	For your safety	7
	1.1 Identification of warning notes	7
	1.2 Qualification of users	7
	1.3 Field of application of the product	8
	1.3.1 Intended use	8
	1.3.2 Product changes	8
	1.4 Safety notes.....	8
2	Device description	11
	2.1 Product overview	15
3	Mounting and installation	17
	3.1 Mounting.....	17
	3.2 Installation	18
	3.2.1 Pin assignment	19
	3.2.2 Supply	21
	3.2.3 Grid types	22
4	Operating and indication elements	27
	4.1 Technical data of the display	27
	4.2 Displaying the events.....	28
	4.3 Operating elements on the display (softkeys).....	29
5	Basic device configuration	31
	5.1 Basic device configuration via the display	31
	5.1.1 Step 1: Language selection	31
	5.1.2 Step 2: Network settings	32
	5.1.3 Step 3: IPv4	32
	5.1.4 Step 4: Grid type	33
	5.1.5 Step 5a: Current input (energy measuring device with current transformer) 34	
	5.1.6 Step 5b: Current input (energy measuring device with Rogowski coil) .	35
	5.1.7 Step 6: Voltage input	35
	5.1.8 Step 7: Configuration overview	36
	5.1.9 Step 8: Setting a personal PIN	36
	5.1.10 Step 9: Activating the PIN	37

5.2	Basic device configuration via the web server	37
5.2.1	Step 1: Network settings	38
5.2.2	Step 2: Selecting the grid type	39
5.2.3	Step 3: Configuration of the current input (current transformer)	40
5.2.4	Step 3: Configuration of the current input (Rogowski coil)	41
5.2.5	Step 4: Voltage input	43
5.2.6	Optional: Voltage transducer	44
5.2.7	Step 5: Configuration overview	45
6	Navigation structure and display	47
6.1	Menu structure on the display	47
6.2	Menu structure on the web server	48
7	Device settings and information	51
7.1	Selecting the language	51
7.2	Date and time	52
7.2.1	Reading the date and time	52
7.2.2	Setting the date and time manually	53
7.2.3	Synchronizing the date and time with an SNTP server	54
7.2.4	Time zones	55
7.2.5	Summer time rule	57
7.3	Adjusting the display (contrast, brightness, illumination time of backlight)	58
7.3.1	Adjusting the contrast of the display	58
7.3.2	Adjusting the brightness of the display	59
7.3.3	Adjusting the illumination time of the backlight	60
7.3.4	Selecting the format of the standard display (IEC or IEEE)	62
7.3.5	Activating color change for alarm	63
7.3.6	Selecting the refresh time for displaying measured values	64
7.3.7	Adjusting the display via the web server	65
7.4	Device information	66
7.5	Resetting the device to default settings	67
8	Configuration	69
8.1	Access and passwords	70
8.1.1	Editing access data via the display	70
8.1.2	Editing access data via the web server	71
8.1.3	Deactivating the configuration via the display	72
8.1.4	Deactivating the Modbus communication interface	73

8.2	Transferring configuration data	75
8.2.1	Exporting configuration data	75
8.2.2	Importing configuration data	76
8.2.3	Direct transfer of configuration data	77
9	Measuring technology	79
9.1	Meter readings.....	79
9.1.1	Energy meters	80
9.1.2	Energy resettable	81
9.1.3	Tariff meter	82
9.1.4	Operating hours counter	83
9.2	Statistics	84
9.2.1	Average values	84
10	Functions	91
10.1	Digital input.....	91
10.1.1	Impulse counter	93
10.1.2	Tariff selection	95
10.1.3	Synchronization of average values	97
10.1.4	Acknowledgment of alarms	99
10.2	Digital output.....	100
10.2.1	Impulse	102
10.2.2	Device status	104
10.2.3	Manually	106
10.2.4	Alarm	107
10.2.5	Rotary field direction	112
10.2.6	Deactivating the digital output	114
10.3	Tariff selection	116
10.3.1	Tariff selection via the communication interface	117
10.3.2	Tariff selection using a time schedule	118
10.4	Logic gate.....	121
10.5	Data logging	126
10.6	Firmware update.....	129
10.6.1	Execution	129
10.6.2	Security	131
11	Communication	133
11.1	Ethernet.....	133
11.1.1	IP addressing	133
11.1.2	Configuration of the communication interface	134
11.1.3	Status of the communication interface	135
11.1.4	Security	135

11.2	Modbus	135
11.2.1	Function	135
11.2.2	Modbus/RTU	136
11.2.3	Modbus/TCP	140
11.2.4	Modbus gateway	140
11.3	PROFINET	142
11.3.1	Software	142
11.3.2	Preparing the GSDML file	142
11.3.3	Integrating the GSDML file	142
11.3.4	Integrating hardware	145
11.3.5	Integrating modules and submodules	151
11.3.6	Linking process data	156
11.3.7	Assigning a device name	157
11.3.8	Function check	162
11.4	Configuration	163
11.4.1	Modbus/RTU	163
11.4.2	Modbus/TCP	163
11.4.3	Modbus gateway	163
11.5	Security	164
11.6	Data types and registers	165
11.7	Register table	167
11.8	Contents of the register table	167
11.9	Description of the register table	167
12	Technical data	173
A	Appendixes	177
A 1	List of figures	177
A 2	List of tables	183
A 3	Index	185

1 For your safety

Read this user manual carefully and keep it for future reference.

1.1 Identification of warning notes



This symbol indicates hazards that could lead to personal injury.

There are three signal words indicating the severity of a potential injury.

DANGER

Indicates a hazard with a high risk level. If this hazardous situation is not avoided, it will result in death or serious injury.

WARNING

Indicates a hazard with a medium risk level. If this hazardous situation is not avoided, it could result in death or serious injury.

CAUTION

Indicates a hazard with a low risk level. If this hazardous situation is not avoided, it could result in minor or moderate injury.



This symbol together with the **NOTE** signal word warns the reader of actions that might cause property damage or a malfunction.



Here you will find additional information or detailed sources of information.

1.2 Qualification of users

The use of products described in this user manual is oriented exclusively to:

- Electrically skilled persons or persons instructed by them. The users must be familiar with the relevant safety concepts of automation technology as well as applicable standards and other regulations.
- Qualified application programmers and software engineers. The users must be familiar with the relevant safety concepts of automation technology as well as applicable standards and other regulations.

1.3 Field of application of the product

1.3.1 Intended use

The EMpro energy measuring devices described in this user manual are suitable for installation in electrical systems with different voltage levels and performance classes.

Keep in mind that electrical systems pose hazards due to high voltages, high short-circuit currents, electric arcs and/or other hazards.

1.3.2 Product changes

Modifications to hardware and firmware of the device are not permitted.

Incorrect operation or modifications to the device can endanger your safety or damage the device. Do not repair the device yourself. If the device is defective, please contact Phoenix Contact.

1.4 Safety notes



WARNING: Risk of death due to electric shock

Only use external current transformers with reinforced or double insulation.

Install current transformers and corresponding measuring devices only when the power supply of the system is disconnected.

- Installation should be carried out as described in the installation notes. Accessing circuits within the device is prohibited.
- Always disconnect the device from the energy supply before performing any work on it. Short-circuit the secondary side of each current transformer.
- Use an appropriate voltage measuring device to ensure that no voltage is present.
- Re-install all the equipment, doors, and covers on the device before switching on the device again.
- Ensure that the control cabinet is grounded in accordance with DIN EN 61439-1.
- Ensure that the control cabinet door in which the device is installed is grounded.
- Provide a switch/circuit breaker close to a device, which is marked as the disconnecting device for this device.
- Provide overcurrent protection (≤ 16 A) for the supply voltage within the installation.
- To protect the device against mechanical or electrical damage, install it in a suitable housing with an appropriate degree of protection in accordance with IEC 60529.
- If the device is not used as described in the documentation, the provided protection may be impaired.
- The housing of the device is equipped with basic insulation against neighboring devices up to 300 V OVC III (overvoltage category). Please note that a minimum clearance of 6 mm to neighboring elements must be maintained to achieve double insulation.
- The device is maintenance-free. Repairs may only be carried out by the manufacturer.
- The device must be stopped if it is damaged, was subjected to an impermissible load, stored incorrectly or if it malfunctions.

- Check that the measuring device is working correctly by measuring a known voltage and a known current.
- Ground each current transformer on the secondary side.

2 Device description

The EMpro energy measuring devices (EEM-MA77x types) are universally deployable, high-precision, network-compatible measuring devices with LC display, which can measure, evaluate and process voltages and currents in one, two and three-phase power supply systems. For voltage measurements, up to four inputs are available; for current measurements, up to three inputs are available. You can use EMpro energy measuring devices in TN and IT systems.

Typical installation locations of EMpro energy measuring devices are:

- Assemblies of switchgear and controlgear, assembly of switchgear and controlgear systems
- Control panels
- Control desks

To enable versatile use, EMpro energy measuring devices are available for the following installation methods:

- For front panel installation or with DIN rail adapter, with LC display, with control buttons
- For DIN rail installation, with LC display, with control buttons (included in the EMpro product family, but not described in this user manual)
- For DIN rail installation, without LC display, without control buttons (included in the EMpro product family, but not described in this user manual)



If you use a DIN rail adapter (EEM-MKT-DRA, Order Number 2902078), you can mount EMpro energy measuring devices for front panel installation on a 35 mm DIN rail.

Your advantages:

- Precise knowledge of load profiles allows load management, optimization of the electrical energy usage and optimization of energy consumption from the public supply network and own production (e.g., CHP, PV system).
- Meaningful load profiles are an important aid for planning system expansions and building new systems.
- Energy costs can be assigned to individual functional divisions or cost centers.
- A transparent overview of the energy flows increases the awareness of energy consumption, uncovers waste of energy and makes it possible to identify energy-intensive system components and equipment that harbors potential energy savings.
- Critical system states can be detected, reported and registered. Such critical system states can, e.g., be caused by overload, unbalanced load, undervoltage, voltage and current distortion by non-linear consumers, etc. Detection of critical system states makes it possible to quickly react to such states in order to prevent potential decreases in availability or energy supply failures. When critical system states are detected in time, measures can be taken to ensure permanent system availability.
- Seamless communication with control systems via Modbus/RTU, Modbus/TCP, PROFINET and EtherNet/IP™ and with higher-level energy management systems via standard TCP/IP networks (Ethernet, RJ45)
- Intuitive configuration and operation of EMpro energy measuring devices with four front buttons or integrated web server

Numerous parameters that are important for operating an electrical system are determined by means of the voltages and currents measured by the EMpro energy measuring devices. Apparent power, active power and reactive power are measured in all four quadrants (consumption, supply).

EMpro energy measuring devices have an integrated web server. It enables:

- Convenient configuration
- Data logging
- Mains quality evaluations
- Detailed recording of energy flows

A configurable digital input and a configurable digital output are also available. Communication interfaces to higher-level control systems are integrated in the device, depending on the type.

Currents can be measured with current transformers or Rogowski coils. If you use Rogowski coils, you do not need an external measuring transducer. EMpro energy measuring devices can be connected directly to Rogowski coils from any manufacturer. Different device types are deployed depending on whether current transformers or Rogowski coils are used. Voltages can be measured directly, or by means of voltage transducers.

Voltages and currents are measured using the principle of true r.m.s. value measurement (TRMS) up to the 63rd harmonic, which enables detailed assessment of the mains quality.

When EMpro energy measuring devices with LC display are used, it is possible to locally display measurement values and perform configuration tasks locally by means of buttons. All EMpro energy measuring devices have a Modbus communication interface and an integrated web server. Other communication interfaces are available, depending on the type. Via the web server, all relevant measurement values and parameters can be displayed and the energy measuring devices can be configured. On the web interface, settings can be configured for the following, among others:

- Grid types
- Average values
- Four energy meters for apparent power, active power, reactive power, consumption/supply
- Energy tariff meter
- Logging
- Alarms and behavior in the event of alarms
- Network (TCP/IP)
- Interfaces with higher-level control systems
- Digital output (with logic functions)
- Digital input
- Impulse counter
- Date/time (realtime clock, SNTP compatible)
- Identifier (of metering point)
- Display

Other features of the EMpro energy measuring devices are:

- Firmware update function
- Password protection (local and web-based management (WBM))
- Deactivation of control buttons for configuration
- Sealable connection fields
- Export, import and direct transfer of configuration data
- Color changes on display (white, red) in the event of errors/events

The following measurement values/parameters are shown on the LC displays of EMpro energy measuring devices:

- Voltage U [V] (L-L, L-N)
- Current I [A]
- Frequency f [Hz]
- Active power P [W] (string, total)
- Reactive power Q [var] (string, total)
- Apparent power S [VA] (string, total)
- Power factor PF, λ
- Active power factor, active factor $\cos \Phi$
- Phase shift angle, phase angle Φ (U-U, U-I)
- Total harmonic distortion (ratio) of the voltage, THD U (L-L, L-N)
- Total harmonic distortion (ratio) of the current, THD I
- Energy E [Wh, varh, VAh] (consumption/supply)
- Energy tariff meter E [Wh, varh, VAh] (consumption, supply, meter 1-4)

For the measurement values/parameters voltage U (L-L), U (L-N), current I, frequency f, active power P, reactive power Q and apparent power S, it is possible to switch between:

- Instantaneous = Instantaneous value
- Min = Minimum value (can be reset)
- Max = Maximum value (can be reset)
- AVG = Current average value
- AVG Min = Minimum average value (can be reset)
- AVG Max = Maximum average value (can be reset)

All the measures described above are also available via the web server that has been integrated into the EMpro energy measuring device. In the web browser, the data cannot only be displayed numerically, but also in the form of a convenient analog display with trend charts.

A variety of hardware and software interfaces can be used to communicate with higher-level control systems. At the time this document is written, the following interfaces are available:

- Modbus/RTU (RS-485)
- Modbus/TCP (Ethernet)
- PROFINET (Ethernet, Dual Port)
- EtherNet/IP (Ethernet, Dual Port)

A variety of parameters from the EMpro energy measuring device can be read or configured in order to communicate with higher-level control systems. These parameters, the associated addresses, additional information and help texts are available on the web server. All information required for setting up communication with higher-level control systems is contained in a register table on the integrated web server. It is therefore usually not necessary to look up parameters in the paper copy of the documentation.

The register table contains:

- Device data
 - Device information
 - Device configuration (digital input/digital output)
- Network (TCP/IP)
- Interfaces for higher-level control systems (e.g., Modbus/RTU, Modbus/TCP, PROF-INET, EtherNet/IP™)
- Control and status registers
 - Device control
 - Device status
 - Measuring system control
- Process data
 - Measured values
 - Counter values
 - Impulse counter
 - Statistics
 - Total harmonic distortion THD
 - Harmonics
 - Voltage quality

2.1 Product overview

Table 2-1 Product overview

Description	Front panel devices	
Current measuring input	Current transformer	Rogowski connection
Modbus/TCP	EEM-MA770 2907945	EEM-MA771 2908286
Modbus/TCP + Modbus/RTU	EEM-MA770-R 2907944	EEM-MA771-R 2908285
Modbus/TCP + PROFINET	EEM-MA770-PN 2907946	EEM-MA771-PN 2908301
Modbus/TCP + Ethernet/IP	EEM-MA770-EIP 2907953	EEM-MA771-EIP 2908302

3 Mounting and installation

3.1 Mounting

You can install the device in a front panel or control cabinet door.

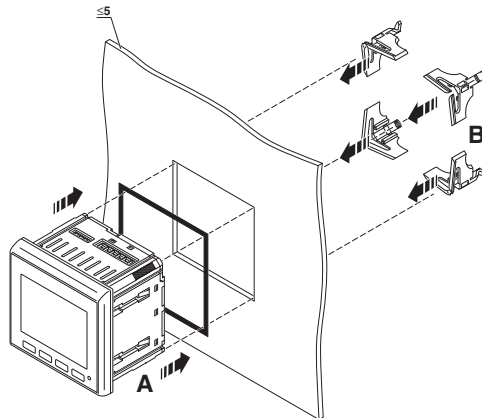

Figure 3-1 Mounting

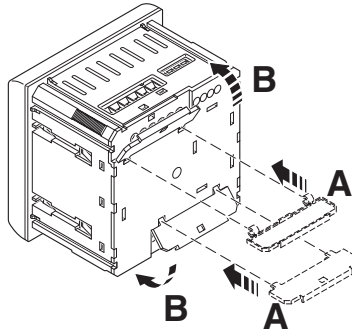

Figure 3-2 Mounting terminal covers

To ensure a firm and tight fit of the device in accordance with IEC 60529/EN 60529, proceed as follows during mounting:

1. Stretch the seal over the rear of the device and position it against the inside of the display.
2. Push the device into the mounting opening from the front. Ensure that the seal is positioned correctly.
3. Secure the device from the rear using the four retaining elements until the device snaps firmly into place.
4. Safeguard the voltage and current measurement inputs against unauthorized access by installing terminal covers.

3.2 Installation



DANGER: Risk of electric shock

If the device is disconnected, the secondary side of the relevant current transformers must be short circuited.

Install the current sensors and corresponding measuring devices only when the power supply of the system is disconnected.

When the current transformer is operated with an open secondary circuit, hazardous voltages may occur at the secondary terminal blocks.



When measuring by means of current transformers or Rogowski coils, the accuracy is greatly influenced by the quality of the current sensors used.

3.2.1 Pin assignment

3.2.1.1 Current transformer



Maximum tightening torque for the relevant screws: 0.5 Nm ... 0.6 Nm.

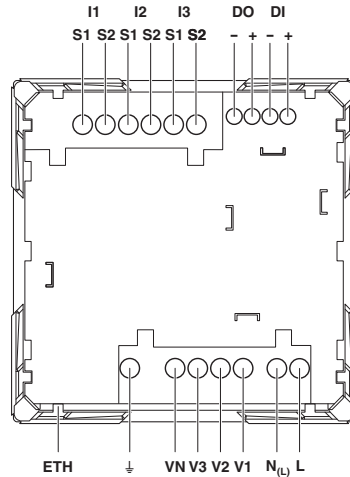

Figure 3-3 Pin assignment example

I1, I2, I3

Current measuring input, current transformer

DI+, DI-

Digital input

DO+, DO-

Digital output

L, N(L)

Supply

V1, V2, V3, VN

Voltage measuring input

⊥ FE

Functional ground

RJ45

Ethernet connection (Modbus)

LED

Status

Optional (depending on the version):

1 x RS-485

RS-485 connection (Modbus/RTU)

2 x ETH RJ45

Ethernet connection (PROFINET)

Ethernet connection (EtherNet/IP)

3.2.1.2 Rogowski coil

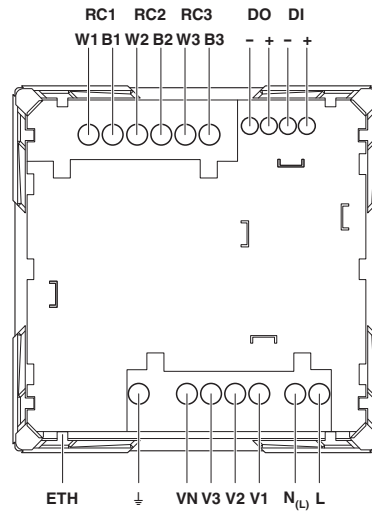

Figure 3-4 Pin assignment example

RC1, RC2, RC3

DI+, DI-

DO+, DO-

L, N(L)

V1, V2, V3, VN

⊥ FE

RJ45

LED

Optional (depending on the version):

1 x RS-485

2 x ETH RJ45

Current measuring input, Rogowski coil

Digital input

Digital output

Supply

Voltage measuring input

Functional ground

Ethernet connection (Modbus)

Status

RS-485 connection (Modbus/RTU)

Ethernet connection (PROFINET)

Ethernet connection (EtherNet/IP)

3.2.2 Supply

You can connect the device supply as follows:

1. Connection (L/N)
2. Connection (L/L)

Connection L/N

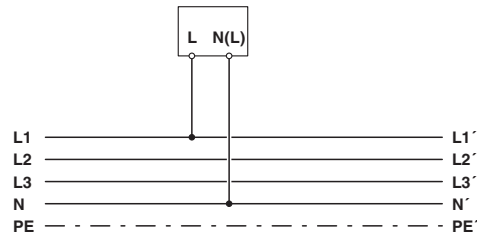

Figure 3-5 Connection L/N

Connection L/L

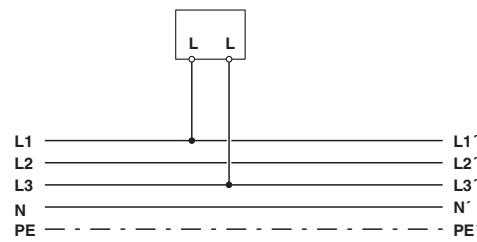

Figure 3-6 Connection L/L

Supply voltage range:	100 V AC ... 400 V AC $\pm 20\%$ 150 V DC ... 250 V DC $\pm 20\%$
Fuse:	≤ 16 A

3.2.3 Grid types

The device is designed for connection to various network types in two-, three- or four-conductor networks with symmetrical or asymmetrical load.

Where current sensors are concerned, a differentiation is made between current transformers and Rogowski coils, depending on the device type.

The definitions of the grid types are as follows:

1PH	One-phase network
2W	Two conductors
1CT	One current transformer
Alternative:	
1RC	One Rogowski coil

3.2.3.1 Current transformer (CT)

1PH-2W-1CT

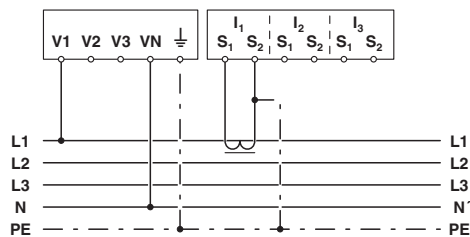

Figure 3-7 One-phase network, two conductors, one current transformer

2PH-2W-1CT

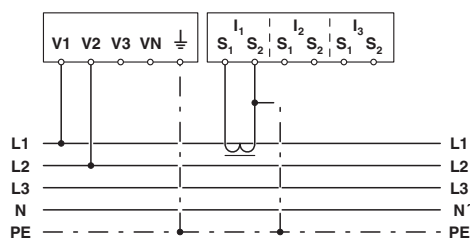

Figure 3-8 Two-phase network, two conductors, one current transformer

3PH-3W-1CT

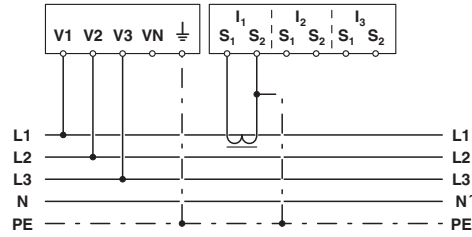

Figure 3-9 Three-phase network, three conductors, one current transformer

3PH-3W-2CT

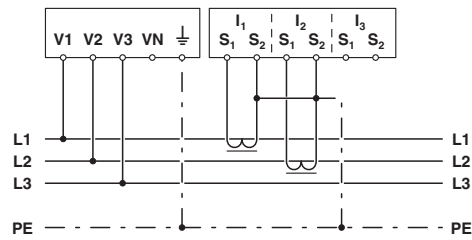

Figure 3-10 Three-phase network, three conductors, two current transformers

3PH-3W-3CT

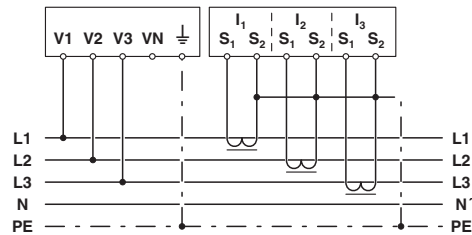

Figure 3-11 Three-phase network, three conductors, three current transformers

3PH-4W-1CT

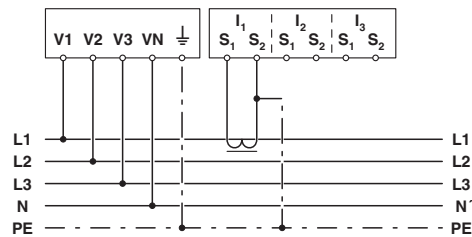

Figure 3-12 Three-phase network, four conductors, one current transformer

3PH-4W-3CT

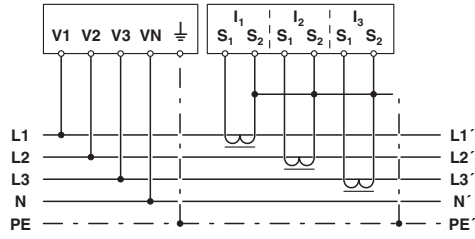

Figure 3-13 Three-phase network, four conductors, three current transformers

2PH-3W-2CT

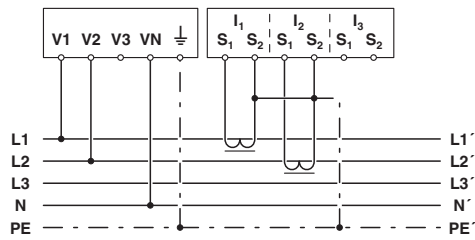

Figure 3-14 Two-phase network, three conductors, two current transformers

3.2.3.2 Rogowski coil (RCP)

1PH-2W-1RC

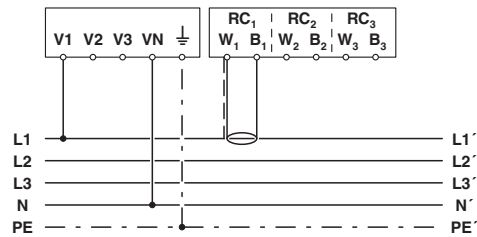

Figure 3-15 One-phase network, two conductors, one Rogowski coil

2PH-2W-1RC

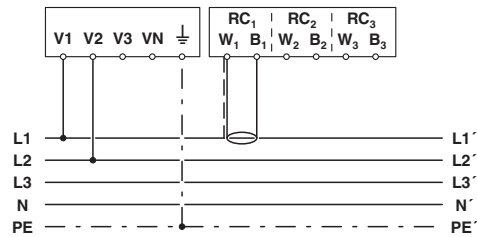

Figure 3-16 Two-phase network, two conductors, one Rogowski coil

3PH-3W-1RC

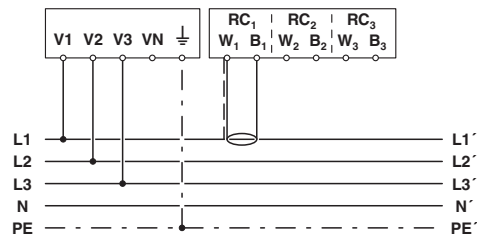

Figure 3-17 Three-phase network, three conductors, one Rogowski coil

3PH-3W-3RC

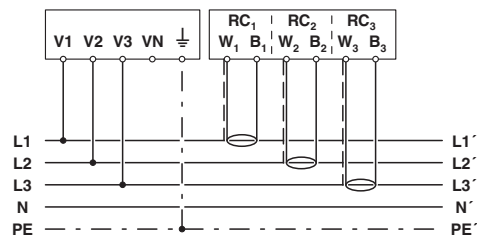

Figure 3-18 Three-phase network, three conductors, three Rogowski coils

3PH-4W-1RC

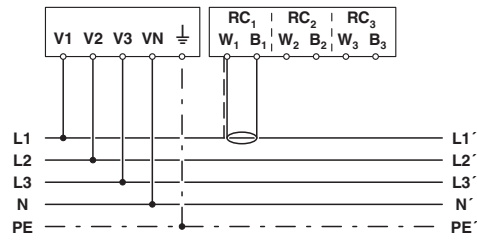

Figure 3-19 Three-phase network, four conductors, one Rogowski coil

3PH-4W-3RC

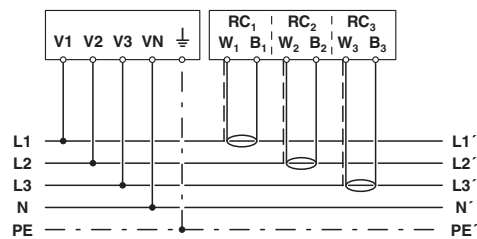

Figure 3-20 Three-phase network, four conductors, three Rogowski coils

2PH-3W-2RC

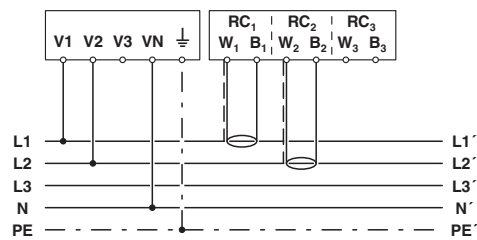
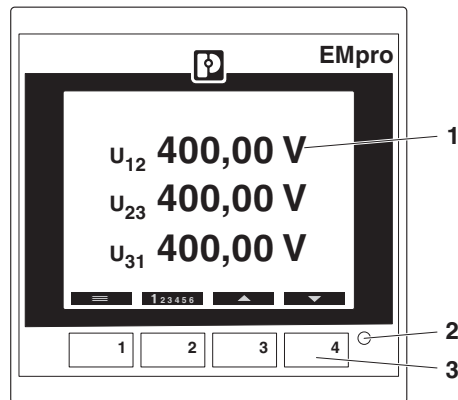

Figure 3-21 Two-phase network, three conductors, two Rogowski coils

4 Operating and indication elements













- 1 LCD display, two-color backlit
- 2 Pulse LED
- 3 Operating buttons 1...4 for displaying measured values and for changing the configuration

4.1 Technical data of the display

Technical data	
Display technology	FSTN positive, transfective
Resolution of devices for installation on front panel	170 x 128
Viewing angle	Min. 30° (horizontal and vertical)
Backlight	White and red













4.2 Displaying the events

Table 4-1 Displaying the events

Icon	Meaning
	Voltage transducer configured
	Measured values faulty (flashing)
	Tariff 1 set
	Tariff 2 set
	Tariff 3 set
	Tariff 4 set
	Network connected
	Warning
	User logged in
	User logged out

4.3 Operating elements on the display (softkeys)

Table 4-2 Meaning of the softkeys

Icon	Meaning
	Open/close settings menu
	Scroll up
	Scroll down
	Select menu page
	Exit menu page
	Edit setting
	Apply modified setting
	Increment (increase)
	Decrement (decrease)
	Next position
	Confirm query
	Reject query/first configuration: go back to start
	Reset: The displayed values are reset.

5 Basic device configuration

The first time the energy measuring device is switched on, the installation wizard for the first configuration (basic device configuration) automatically starts. In the basic device configuration, you can edit the default settings of the device. Depending on the requirements, you can perform the basic device configuration via the display or via the integrated web server.

Menu-driven configuration is available for the following parameters:

- Language
- Network settings
- Grid type
- Current input
- Voltage input

5.1 Basic device configuration via the display

1. To start the first configuration (basic device configuration) of your energy measuring device, press the  button.

Welcome to first
configuration





Figure 5-1 Starting the basic device configuration

5.1.1 Step 1: Language selection



Figure 5-2 Language selection

1. Use the  and  buttons to select the desired language.
2. To proceed, press the  button.

5.1.2 Step 2: Network settings

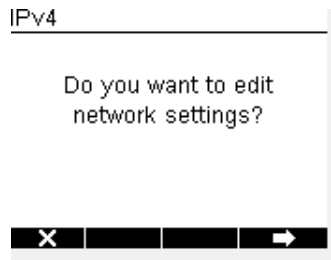

Figure 5-3 Network settings

1. If you do not want to edit the network settings, press the **X** button.
2. If you want to edit the network settings, press the **→** button.

5.1.3 Step 3: IPv4

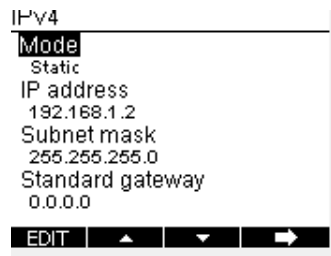

Figure 5-4 IPv4

1. To enter a network setting, use the **↓** or **↑** button to scroll to the desired setting.
2. To open edit mode, press the **EDIT** button.
3. To scroll through the possible values, use the buttons **→** and **+**.
4. Next, apply the settings by pressing the **OK** button.
5. After you have entered all settings, press the **→** button to proceed.

5.1.4 Step 4: Grid type

Current transformer

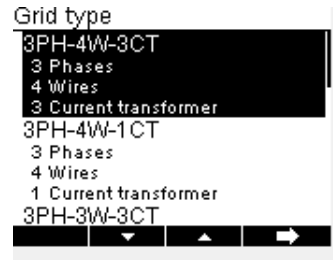

Figure 5-5 Selection of grid type with current transformers

Rogowski coil

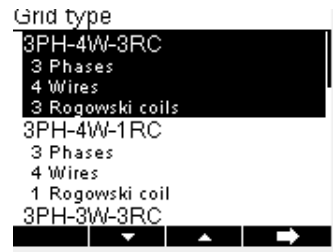





Figure 5-6 Selection of grid type with Rogowski coils

1. Use the  or  button to select the desired grid type.
2. To proceed, press the  button.



Explanations and information on the various grid types are available in [Section "Grid types" on page 22](#).

5.1.5 Step 5a: Current input (energy measuring device with current transformer)

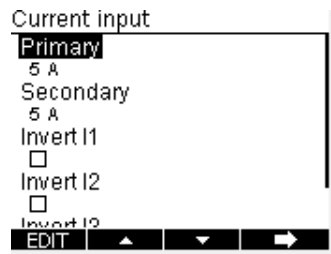

Figure 5-7 Current input (energy measuring device with current transformer)

1. To open the edit mode for the "Primary" device setting, press the **EDIT** button.
2. To set the primary current, press the buttons **▲** and **▼**.
3. To apply the change, press the **OK** button.

To set the secondary current, proceed in the same way as for setting the primary current.

4. To invert the current inputs, activate the checkbox below the appropriate current input with the **EDIT** button.
5. To continue the basic device configuration, press the **→** button.

5.1.6 Step 5b: Current input (energy measuring device with Rogowski coil)

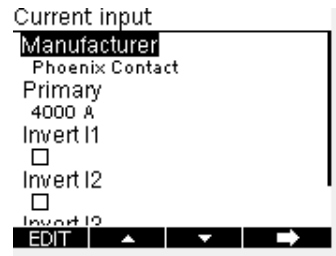

Figure 5-8 Current input (energy measuring device with Rogowski coil)

1. Use the **EDIT** button to open the edit mode of the “Manufacturer” device setting.
2. To make changes, use the buttons **▲** and **▼**.
3. To apply the change, press the **OK** button.

The same procedure applies to editing the nominal current.

4. To activate or deactivate a checkbox, press the **EDIT** button.
5. To continue the basic device configuration, press the **→** button.

5.1.7 Step 6: Voltage input

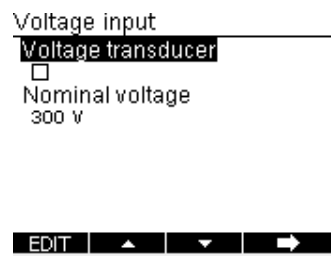

Figure 5-9 Voltage input

1. If you use a voltage transducer, activate the checkbox using the **EDIT** button. When you activate the checkbox, the primary and secondary voltage is displayed.
2. If no voltage transducer is used, enter the nominal voltage by means of the buttons **▲** and **▼**.
3. Select it with the **EDIT** button.
4. Use the buttons **→** and **+** to make changes.
5. To save the changes, press the **OK** button.
6. To proceed, press the **→** button.

5.1.8 Step 7: Configuration overview

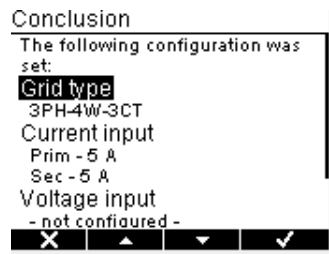





Figure 5-10 Configuration conclusion

1. Use the buttons  and  to check your configured settings.
2. If you are satisfied with the first configuration, finish it by pressing the  button.
3. To restart the first configuration, press the  button.

5.1.9 Step 8: Setting a personal PIN

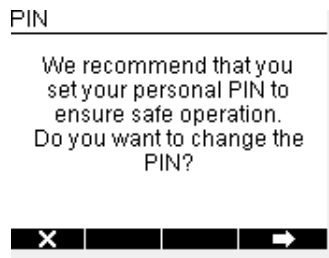



Figure 5-11 Setting a personal pin

1. To ensure safe operation, you can select a personal PIN. To this end, press the  button.
2. If you do not want to change the PIN, press the  button.

5.1.10 Step 9: Activating the PIN

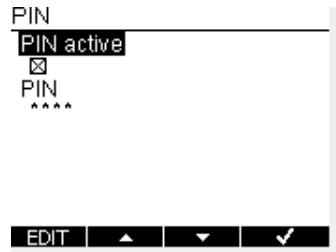

Figure 5-12 Activating the PIN

1. To activate the PIN, press the **EDIT** button.
2. Use the buttons **→** and **+** to enter the desired PIN.
3. To apply the changes, press the **OK** button.
4. To finish the basic device configuration, press the **✓** button.



To ensure safe operation, we recommend changing the access data for the display!

For additional information, please refer to [Section “Configuration” on page 69](#).

5.2 Basic device configuration via the web server



We recommend using the integrated web server to perform the device configuration. You can access the web server directly after you have switched on the device. An installation wizard guides you through the basic device configuration process.

By default, a static IP address is set for the device. To start the basic device configuration via the web server, open the Internet browser. Enter the following URL:

IP address:	192.168.1.2
Subnet mask:	255.255.255.0
Default gateway:	0.0.0.0
DHCP:	Off
DNS server:	0.0.0.0

Make sure that your computer and the energy measuring device are in the same network.

5.2.1 Step 1: Network settings

The first step in the basic device configuration is the network settings.

Navigation on the web server

“Network settings”

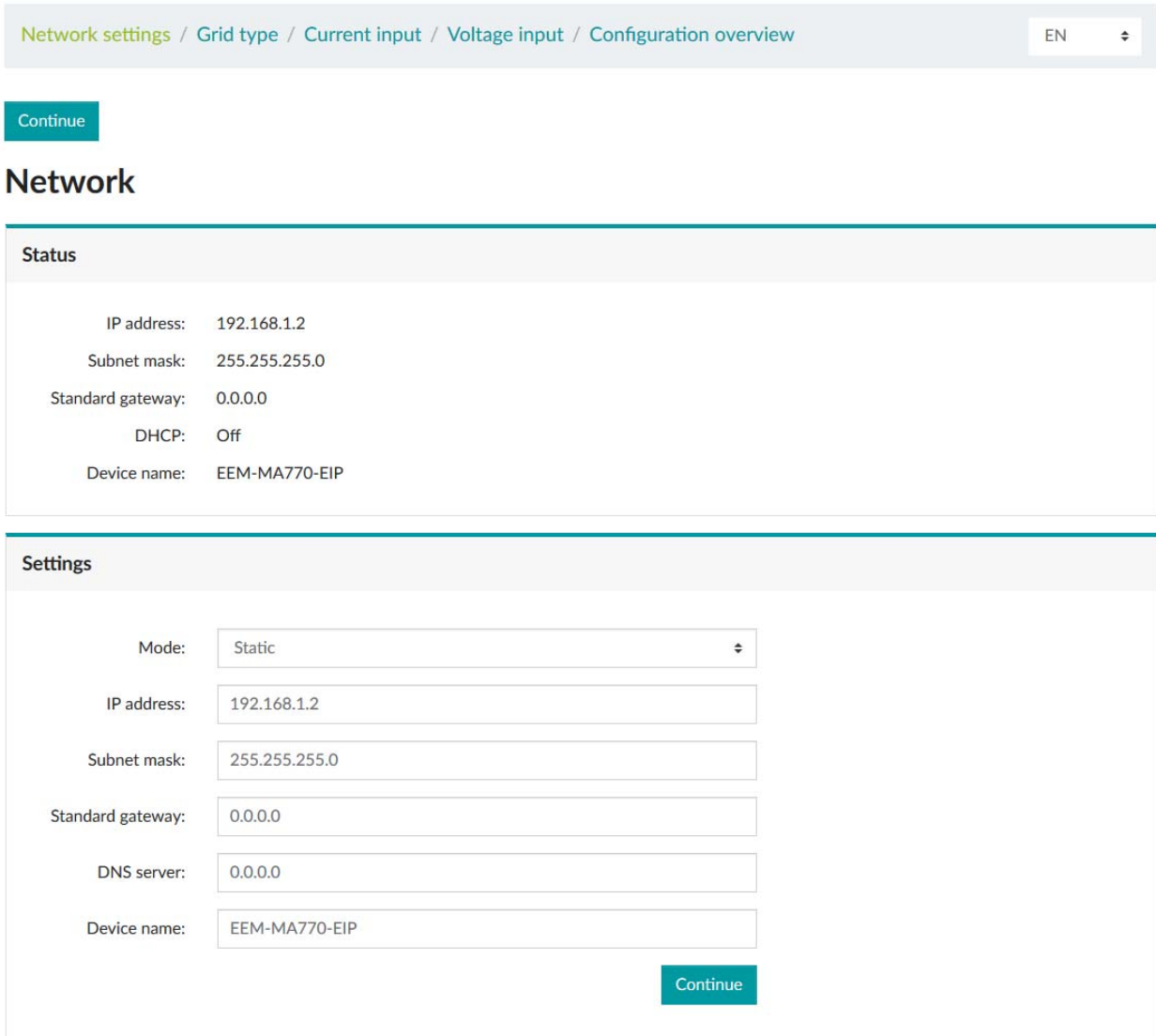

Figure 5-13 Network settings

Status

Here, an overview of the current network configuration is displayed.

Settings

Enter the desired network settings as appropriate for the respective application.

5.2.2 Step 2: Selecting the grid type

The second step is the selection of the grid type for the application.

Network settings / Grid type / Current input / Voltage input / Configuration overview EN ▾

Back Continue

1 phase with neutral - 1PH_2W_1CT
current transformer

2 phase without neutral - 2PH_2W_1CT
current transformer

3 phase without neutral - 3PH_3W_1CT
current transformer

3 phase without neutral - 3PH_3W_2CT
2 current transformers

3 phase without neutral - 3PH_3W_3CT
3 current transformers

3 phase with neutral - 3PH_4W_1CT
current transformer

3 phase with neutral - 3PH_4W_3CT
3 current transformers

2 phase with neutral - 2PH_3W_2CT
2 current transformers

Back Continue

Figure 5-14 Grid type

Taking the device installation into account, select the desired grid type from the options provided in the overview.

5.2.3 Step 3: Configuration of the current input (current transformer)



Depending on the device selection and the associated device-specific current sensors, the current input setting may vary.

Configuring the current input is the third step of the basic device configuration.

Network settings / Grid type / **Current input** / Voltage input / Configuration overview EN ▾

Back **Continue**

Primary: A

Secondary: A

Invert I1:

Invert I2:

Invert I3:

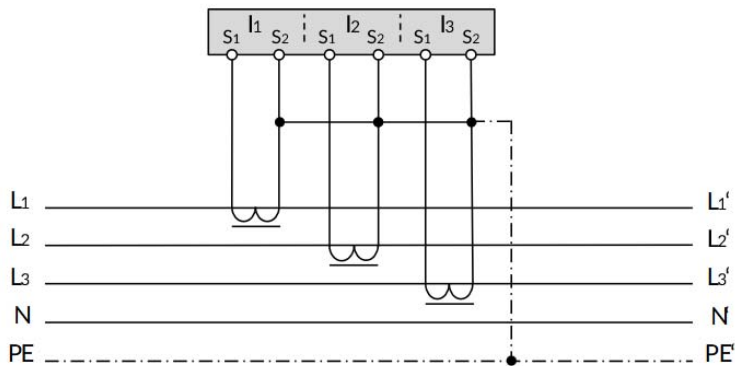

Back **Continue**

Figure 5-15 Current input, current transformer

Primary

Enter the primary current of the application here.

Secondary

Select the secondary current (1 A or 5 A) of the current transformer.

Invert

With this function, the respective phase of the current transformer is inverted by the firmware. It is no longer necessary to rewire the two conductors.

5.2.4 Step 3: Configuration of the current input (Rogowski coil)



Depending on the device selection and the associated device-specific current sensors, the current input setting may vary.

Configuring the current input is the third step of the basic device configuration.

Network settings / Grid type / **Current input** / Voltage input / Configuration overview EN

Back **Continue**

Primary: A

Preselection: **Phoenix Contact coil D95** Phoenix Contact coil D140 Phoenix Contact coil D190

Transmission factor: mV / kA

Internal resistance: Ω

Invert I1:

Invert I2:

Invert I3:

Back **Continue**

© 2019 PHOENIX CONTACT - Version: 1.1.2

Figure 5-16 Current input (Rogowski coil)

Primary

Enter the primary current of the application here.

Preselection

Select a Rogowski coil from Phoenix Contact. You do not have to configure any other settings.

EMpro - multi-functional energy measuring devices for front panel installation

Invert I1

With this function, the respective phase of the Rogowski coil is inverted by the firmware. It is no longer necessary to rewire the two conductors.

If you use Rogowski coils from manufacturers other than Phoenix Contact, you have to configure additional settings.

Transmission factor

Enter the amplitude transmission factor (mV/kA) of the Rogowski coil.

Refer to the documentation of the Rogowski coil for the amplitude transmission factor.

Internal resistance

Enter the internal resistance (Ω) of the Rogowski coil.

Refer to the documentation of the Rogowski coil for the internal resistance.

Invert

With this function, the respective phase of the Rogowski coil is inverted by the firmware. It is no longer necessary to rewire the two conductors.

5.2.5 Step 4: Voltage input

If you use a voltage transducer in your application, activate the checkbox here. Subsequently follow the next steps.

Network settings / Grid type / Current input / Voltage input / Configuration overview

EN

Back Continue

Voltage transducer:

Nominal voltage: V

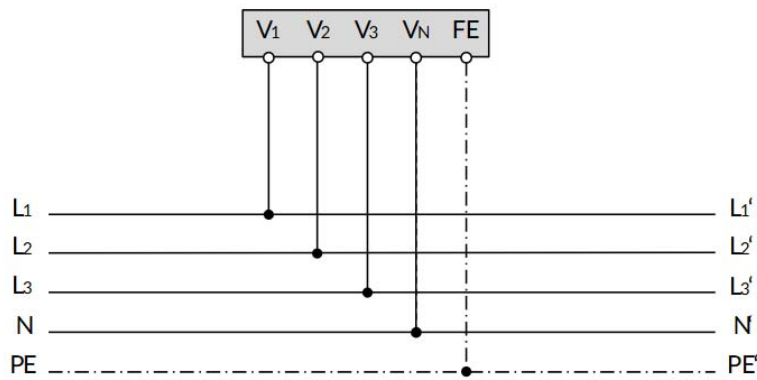

Back Continue

Figure 5-17 Voltage input

5.2.6 Optional: Voltage transducer

Back Continue

Voltage transducer:

Primary: V

Secondary: V

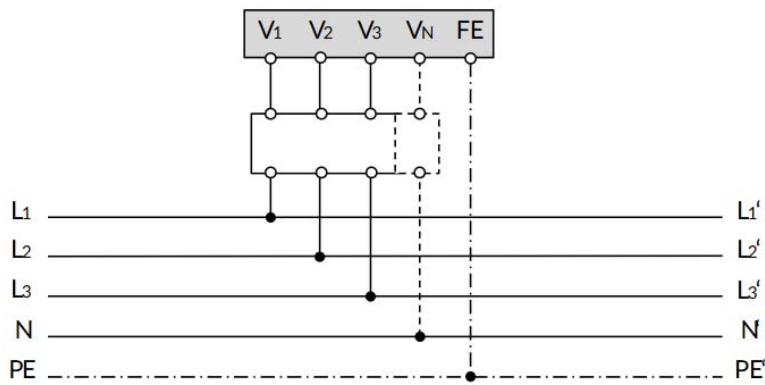

Back Continue

Figure 5-18 Voltage input with voltage transducer

Primary Enter the primary voltage of the voltage transducer.

Secondary Enter the secondary voltage of the voltage transducer.

5.2.7 Step 5: Configuration overview

Network settings / Grid type / Current input / Voltage input / Configuration overview EN

We recommend that you change the password for this website and the PIN for Modbus and possibly the display to ensure safe operation. ×

Back Complete

Configuration overview

Network settings

IP address: 192.168.1.2
 Subnet mask: 255.255.255.0
 Standard gateway: 0.0.0.0
 DNS server: 0.0.0.0
 DHCP: Off

Grid type

3PH_4W_3CT:
 3 phase with neutral
 3 current transformers

Current input

Primary: 5A
 Secondary: 5A
 Invert I1:
 Invert I2:
 Invert I3:

Voltage input

Voltage transducer:
 Primary: 60V
 Secondary: 300V

Back Complete

Figure 5-19 Configuration overview

Check all settings and close the basic device configuration.



For your own safety, we recommend changing the access data for the web server!

6 Navigation structure and display

6.1 Menu structure on the display

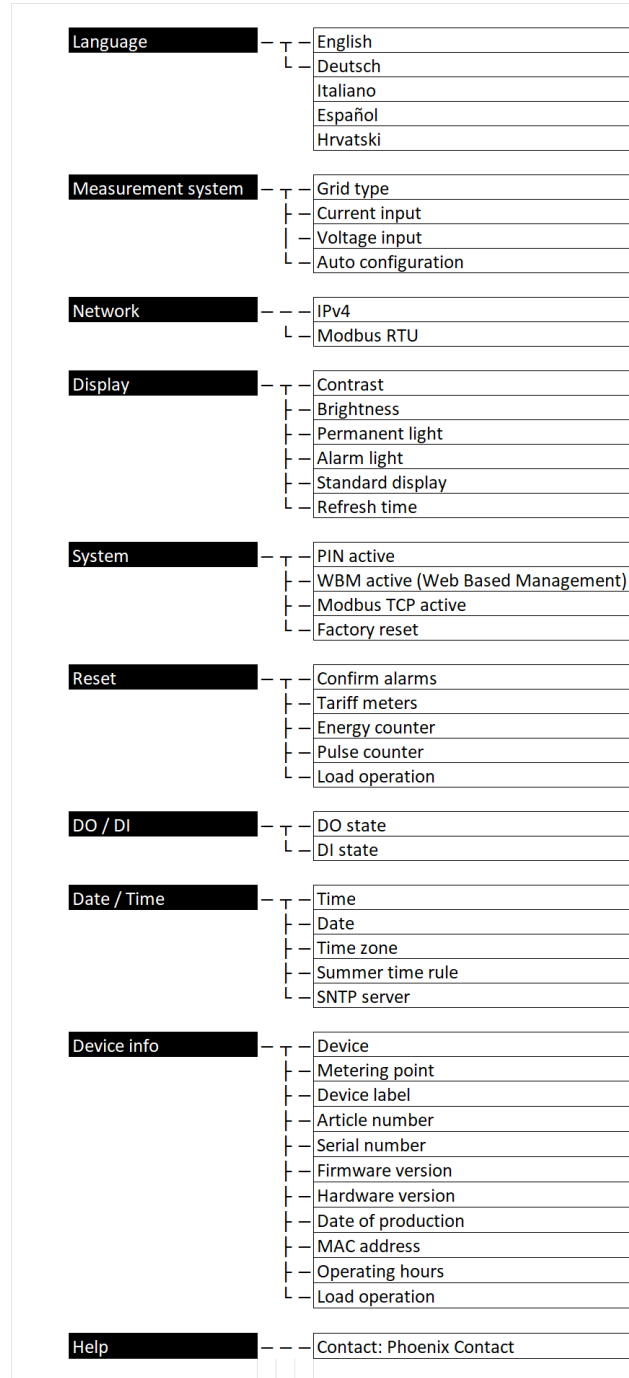

Figure 6-1 Menu structure on the display

6.2 Menu structure on the web server

EN ↕

EEM-MA770-EIP
Device label: Device label
Metering point: Metering point

Home

- Instantaneous values
- Meter readings
- Statistics
- Register table

Settings

- Measurement system
- Average values
- Tariffs
- Logging
- Alarming

Network

- Modbus
- Digital output
- Digital input
- Impulse counter
- Date / Time
- Identifier
- Display

System

- Device information
- User management
- Configuration data
- Firmware
- Help

Instantaneous values

Phase conductor voltage	
U12	0,00 V
U23	0,00 V
U31	0,00 V
UsysLL	0,00 V

Phase voltage	
U1	0,00 V
U2	0,00 V
U3	0,00 V
UsysLN	0,00 V

Current	
I1	0,00 A
I2	0,00 A
I3	0,00 A
IN	0,00 A
Isys	0,00 A

Frequency	
f	0,00 Hz

Active power	
P1	0,00 W
P2	0,00 W
P3	0,00 W
ΣP	0,00 W

Reactive power	
Q1	0,00 var
Q2	0,00 var
Q3	0,00 var
ΣQ	0,00 var

Apparent power	
S1	0,00 VA
S2	0,00 VA
S3	0,00 VA
ΣS	0,00 VA

Power factor	
PF1	1,00
PF2	1,00
PF3	1,00
PF	1,00

cos(φ)	
cos(φ1)	1,00
cos(φ2)	1,00
cos(φ3)	1,00

Phase angle U-I	
φ1	0,00 °
φ2	0,00 °
φ3	0,00 °

Phase angle U-U	
φ1N	0,00 °
φ2N	0,00 °
φ3N	0,00 °

THD phase conductor voltage	
U12	0,00 %
U23	0,00 %
U31	0,00 %

THD phase voltage	
U1	0,00 %
U2	0,00 %
U3	0,00 %

THD current	
I1	0,00 %
I2	0,00 %
I3	0,00 %
IN	0,00 %

Figure 6-2 Menu structure on the web server

The figure shows the start screen of the web server in operating mode after the basic device configuration has been completed.

The following information appears in the header:

- Order designation
- Equipment identification (EID) of the device, which you can name as desired
- A defined measuring point, which you can name as desired
- Language selection

The menu tree contains the following:

Home:	Reading measured data and measurement values
Settings:	Configuring the device and device parameters
System:	Managing rights and provision of information and data

7 Device settings and information

7.1 Selecting the language



The languages for the display and the web server can differ. Thus, changing the language via the display does not affect the language set in the web server, and vice versa.

Navigation on the display

“Language”

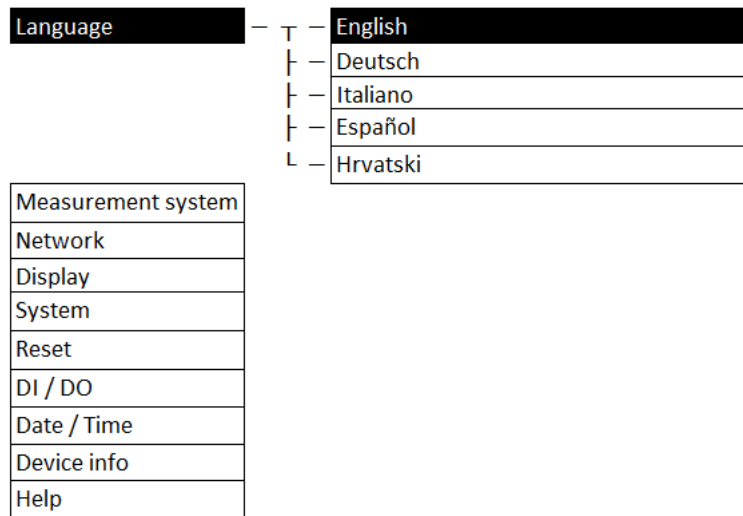

Figure 7-1 “Language” menu

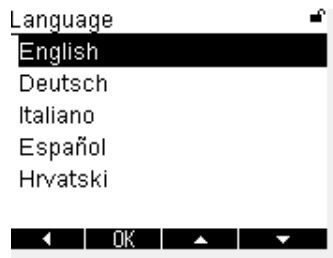

Figure 7-2 Language selection

You can select the display language via the display.

The default setting for the language is English.

7.2 Date and time



When the device is switched off, or in the event of a power loss, the device retains the system time for at least one day.

This is usually adequate for maintenance and installation work.

7.2.1 Reading the date and time

Navigation on the display

“Date / Time”

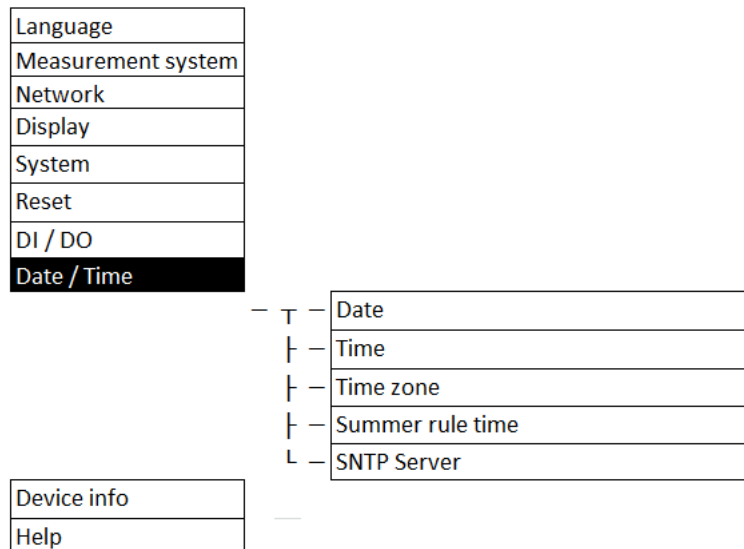

Figure 7-3 “Date / Time” menu

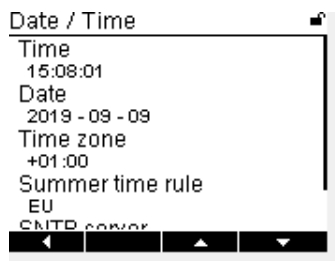

Figure 7-4 Settings: “Date / Time”

On the device display, you can only read the date and time settings.

The date and time settings can only be changed via the integrated web server or the Modbus communication interface.

The web server provides the following modes for setting the date and time:

- Manually
- SNTP server

7.2.2 Setting the date and time manually

Navigation on the web server

“Settings, Date / Time, Settings, Manually” mode

Date / Time

Status

Time: 11:05:07 AM
Date: 09/09/2019

Settings

Mode: Manually

Time: 11:04:26

Date: 09.09.2019

Time zone: UTC+01:00 Africa (Lagos, Tunis), Europe (Amsterdam)

Summer time rule: EU

Figure 7-5 “Settings, Date / Time, Settings, Manually” mode

Status

Here, the current date and current time are shown.

Settings

Here, you can change the settings for the date and time.

Time zone

Here, you can select a time zone. You can find a list of all time zones in [Section “Time zones” on page 55](#).

Summer time rule

Here, you can select a summer time rule. A description of the summer time rules can be found in [Section “Summer time rule” on page 57](#).

7.2.3 Synchronizing the date and time with an SNTP server

Navigation on the web server

“Settings, Date / Time, Settings, SNTP Server” mode

Date / Time

Status

Time: 4:59:04 PM
Date: 12/22/2019

Settings

Mode: SNTP server

SNTP server: europe.pool.ntp.org Check connection

Polling cycle: 300 s

Time zone: UTC+01:00 Africa (Lagos, Tunis), Europe (Amsterdam, Belgrad, Berlin, Brüssel)

Summer time rule: EU

Discard Save

Figure 7-6 Menu: “Settings, Date / Time, Settings, SNTP Server” mode

Settings

Here, you can change the settings for the date and time.

Mode

Via the “SNTP server” Modbus, the internal clock of the device is automatically synchronized with an SNTP server (Simple Network Time Protocol).

SNTP server

Enter the address or the URL of the SNTP server and check the entered address by clicking “check connection”.

Polling cycle

Enter the desired polling rate in seconds (s).

Time zone

Here, you can select a time zone. You can find a list of all time zones in [Section “Time zones” on page 55](#).

Summer time rule

Here, you can select a summer time rule. A description of the summer time rules can be found in [Section “Summer time rule” on page 57](#).

7.2.4 Time zones

Navigation on the web server

“Settings, Date / Time, Settings, Time zone”

GMT -12:00	
GMT -11:00	Pacific (Midway, Niue, Samoa)
GMT -10:00	Pacific (Hawaii, Honolulu, Tahiti)
GMT -09:30	Pacific (Marquesas)
GMT -09:00	America (Anchorage, Yakutat, Alaska)
GMT -08:00	America (Los Angeles, Vancouver, Tijuana)
GMT -07:00	America (Denver, Edmonton, Phoenix, Yellowknife)
GMT -06:00	America (Chicago, Cancun, Mexico City, Costa Rica, Winnipeg)
GMT -05:00	America (Cayman, Bogota, Havana, Lima, New York, Panama, Toronto)
GMT -04:30	America (Caracas)
GMT -04:00	America (Asuncion, Barbados, Grenada, Santiago)
GMT -03:30	America (St. Johns), Canada (Newfoundland)
GMT -03:00	America (Buenos Aires, Cordoba, Bahia, Recife, Sao Paulo)
GMT -02:00	America (Noronha), Atlantic (South Georgia)
GMT -01:00	Atlantic (Azores, Cape Verde)
GMT 00:00	Africa (Accra, Dakar)
	Europe (Lisbon, Madeira, Reykjavik, Dublin, London)
GMT +01:00	Africa (Lagos, Tunis)
	Europe (Amsterdam, Belgrade, Berlin, Brussels, Copenhagen, Paris, Rome)
GMT +02:00	Africa (Cairo, Johannesburg)
	Europe (Helsinki, Athens, Riga, Sofia)
GMT +03:00	Africa (Mogadishu, Nairobi),
	Asia (Baghdad, Bahrain, Kuwait, Qatar),
	Europe (Minsk, Kaliningrad)
GMT +04:00	Asia (Tehran, Baku, Dubai)
	Europe (Moscow, Volgograd)
	India (Mahe, Mauritius, Reunion)
GMT +04:30	Asia (Kabul)
GMT +05:00	Asia (Dushanbe, Tashkent)
	India (Maldives)
GMT +05:30	Asia (Calcutta, Colombo)
GMT +05:45	Asia (Kathmandu)
GMT +06:00	Asia (Almaty, Bishkek, Dacca, Yekaterinburg, Thimbu)
GMT +06:30	Asia (Rangoon), India (Cocos)
GMT +07:00	Asia (Bangkok, Jakarta, Novosibirsk, Omsk)

EMpro - multi-functional energy measuring devices for front panel installation

GMT +08:00	Asia (Brunei, Hong Kong, Kuala Lumpur, Singapore, Taipei, Manila), Australia (Perth, West)
GMT +08:45	Australia (Eucla)
GMT +09:00	Asia (Irkutsk, Seoul, Tokyo)
GMT +09:30	Australia (Adelaide, Darwin, North, South)
GMT +10:00	Asia (Yakutsk) Australia (Brisbane, Melbourne, Queensland, Sydney, Tasmania)
GMT +11:00	Asia (Vladivostok) Pacific (Guadalcanal)
GMT +11:30	Pacific (Norfolk)
GMT +12:00	Asia (Kamchatka) Pacific (Auckland, Fiji, Majuro)
GMT +12:45	Pacific (Chatham)
GMT +13:00	Pacific (Apia, Enderbury, Tongatapu)
GMT +14:00	Pacific (Kiritimati)

7.2.5 Summer time rule

Navigation on the web server

“Settings, Date / Time, Settings, Summer time rule”

Date / Time

Status	
Time:	5:02:35 PM
Date:	12/22/2019

Settings	
Mode:	SNTP server
SNTP server:	<input type="text" value="europe.pool.ntp.org"/> <input type="button" value="Check connection"/>
Polling cycle:	<input type="text" value="300"/> s
Time zone:	UTC+01:00 Africa (Lagos, Tunis), Europe (Amsterdam, Belgrad, Berlin, Brüssel)
Summer time rule:	Manually
Based on UTC:	<input checked="" type="checkbox"/>
Begin summer time:	<input type="text" value="Last"/> <input type="text" value="Sunday"/> <input type="text" value="in"/> <input type="text" value="March"/> <input type="text" value="01:00"/> <input type="text" value="o'clock"/>
End summer time:	<input type="text" value="Last"/> <input type="text" value="Sunday"/> <input type="text" value="in"/> <input type="text" value="October"/> <input type="text" value="01:00"/> <input type="text" value="o'clock"/>
	<input type="button" value="Discard"/> <input type="button" value="Save"/>

Figure 7-7 Menu: “Settings, Date / Time, Settings, Summer time rule”

Status

Here, the current date and current time are shown.

Settings

Here, you can change the settings for the date and time.

You can select the summer time rule for Europe or the USA, or set a summer time rule manually. If you set the summer time rule manually, you can specify the start and end of the summer time rule:

- Month
- Day of week
- Hours
- Minutes

7.3 Adjusting the display (contrast, brightness, illumination time of backlight)

7.3.1 Adjusting the contrast of the display

Navigation on the display "Display, Contrast"

Contrast

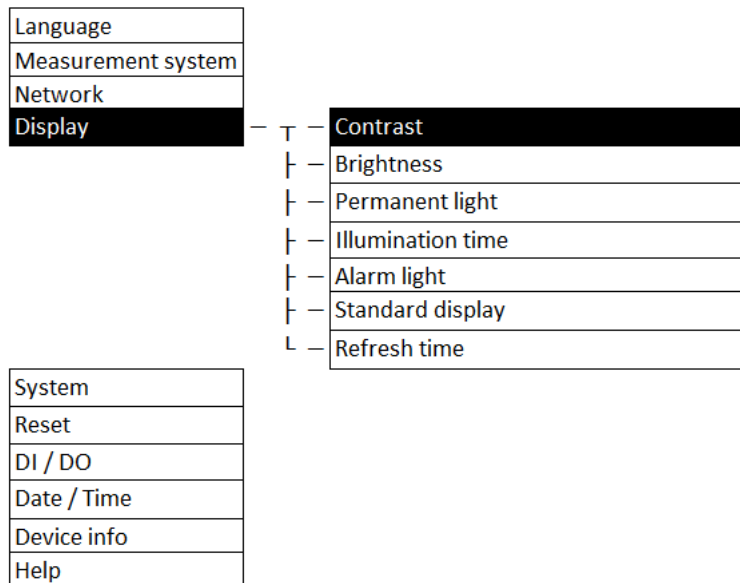

Figure 7-8 Menu: "Display, Contrast"



Figure 7-9 Settings: "Display, Contrast"

You can set the contrast of the display. The default setting for the contrast is 50%.

7.3.2 Adjusting the brightness of the display

Navigation on the display "Display, Brightness"

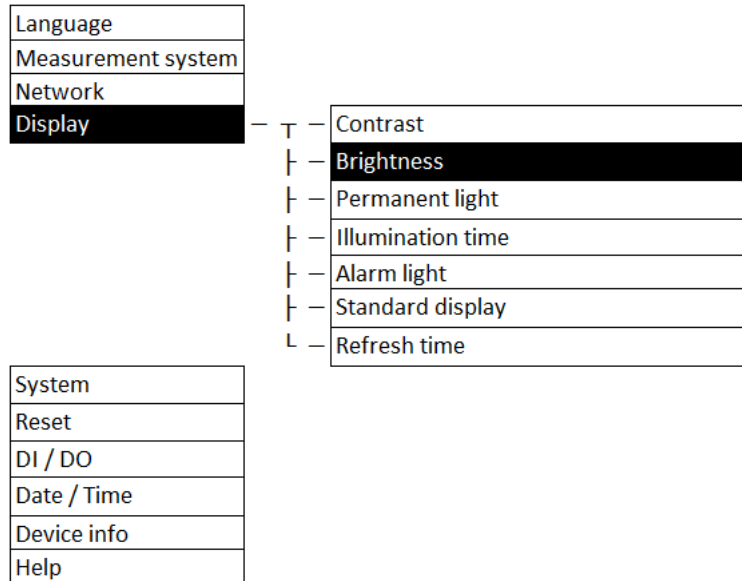

Figure 7-10 Menu: "Display, Brightness"



Figure 7-11 Settings: "Display, Brightness"

You can adjust the brightness of the display. The default setting for the brightness of the display is 100%.

7.3.3 Adjusting the illumination time of the backlight

Navigation on the display "Display, Permanent light"

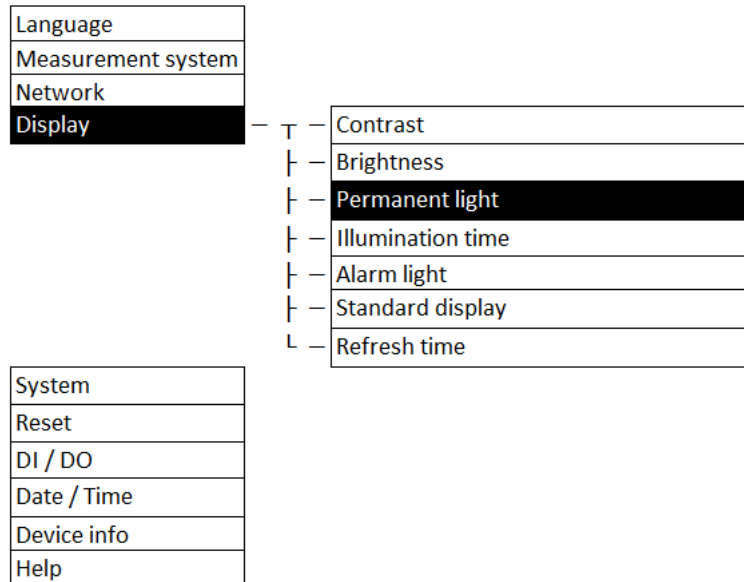

Figure 7-12 Menu: "Display, Permanent light"



Figure 7-13 Settings: "Display, Permanent light"

Permanent light

When the “Permanent light” checkbox is enabled, the white backlight of the display is on permanently.



Figure 7-14 Settings: “Illumination time”

Permanent light

When the “Permanent light” checkbox is disabled, the white backlight of the display is off.

Illumination duration

When the “Permanent light” checkbox is disabled, you can freely define the duration for which the backlight remains lit.

The default setting for the illumination time is 20 seconds.

You can also change the settings for the illumination time via the web server.

7.3.4 Selecting the format of the standard display (IEC or IEEE)

Navigation on the display “Display, Standard display”

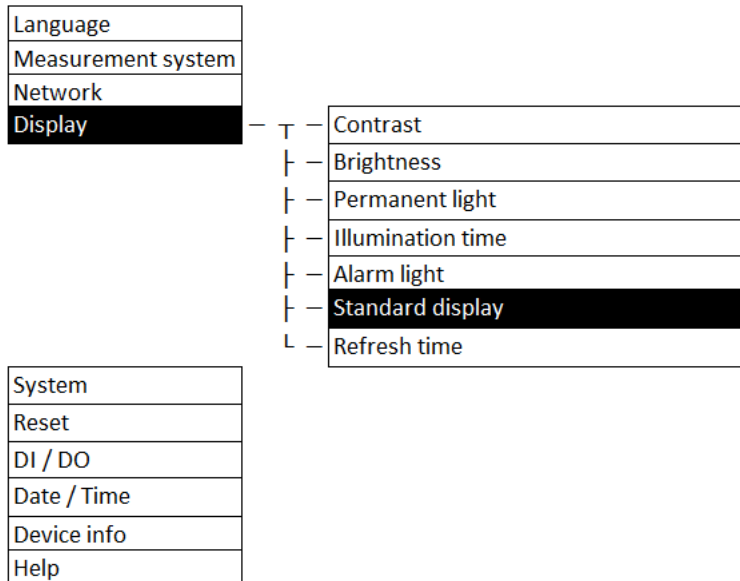

Figure 7-15 Menu: “Display, Standard display”



Figure 7-16 Settings: “Display, Standard display”

Standard display

You can choose between the formats IEC and IEEE for displaying the measured values and the associated units.

The default setting is IEC.

You can also change the format for the standard displays via the web server (see [Section “Adjusting the display via the web server” on page 65](#)).

7.3.5 Activating color change for alarm

Navigation on the display “Display, Alarm light”

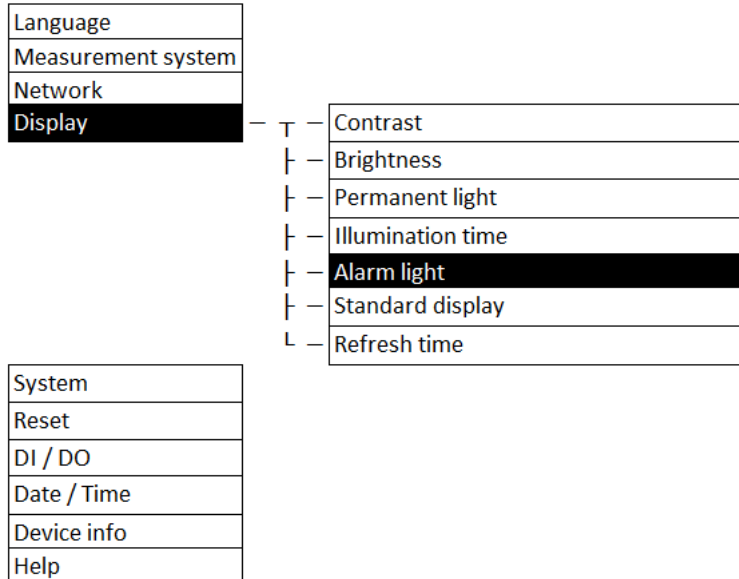

Figure 7-17 Menu: “Display, Alarm light”

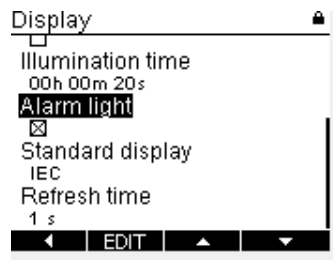

Figure 7-18 Settings: “Display, Alarm light”

Alarm light

The backlight of the display can change from white to red in the event of an error (color change).

When the “Alarm light” checkbox is enabled, the color change is active.

In the default setting, the color change is enabled.

You can also change the settings for the alarm light via the web server (see [“Red color change in case of error”](#) on page 65).

7.3.6 Selecting the refresh time for displaying measured values

Navigation on the display "Display, Refresh time"

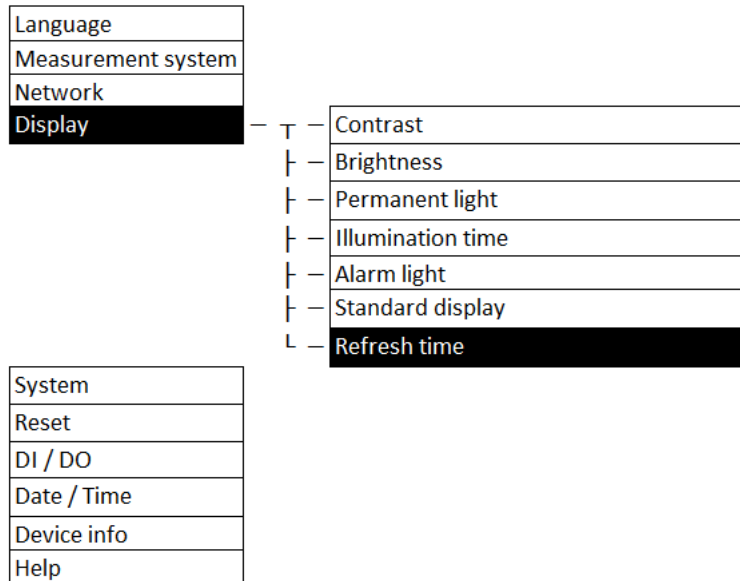

Figure 7-19 Menu: "Display, Refresh time"

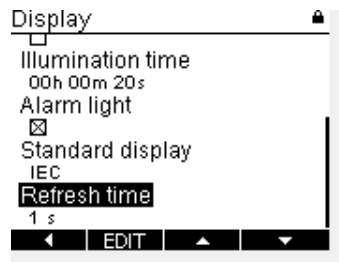

Figure 7-20 Settings: "Display, Refresh time"

Refresh time

You can choose between three refresh times for displaying the measured values:

- 500 ms
- 1 s
- 2 s

The default setting for the refresh time is 1 s.

7.3.7 Adjusting the display via the web server

Navigation on the web server

“Settings, Display”

Display

The screenshot shows the 'Display' settings page. It features a 'Status' header. Below it, there are four main settings sections:

- Standard display:** A dropdown menu currently set to 'IEC'.
- Activate configuration via display:** A checkbox that is checked.
- Illumination duration:** A dropdown menu set to 'Set duration', followed by a time input field showing '00:00:20' and a unit selector 'hh:mm:ss'.
- Red color change in case of error:** A checkbox that is checked.

 At the bottom right of the settings area, there are two buttons: 'Discard' and 'Save'.

Figure 7-21 Web server: “Settings, Display”

Status	Here, the current settings for the display are shown. It is also possible to modify them here.
Standard display	Here, you can choose between the formats “IEC” or “IEEE”.
Activate configuration via display	If this checkbox has been enabled, you can configure the device via the display.
Illumination duration	Here, you can select between: <ul style="list-style-type: none"> – Steady off – Set duration (in hh:mm:ss) – Steady on
Red color change in case of error	If this checkbox is enabled, the color change in the event of an error is active. If this checkbox is disabled, the color change in the event of an error is inactive. In the default setting, this checkbox is enabled.

7.4 Device information

Navigation on the display "Device info"

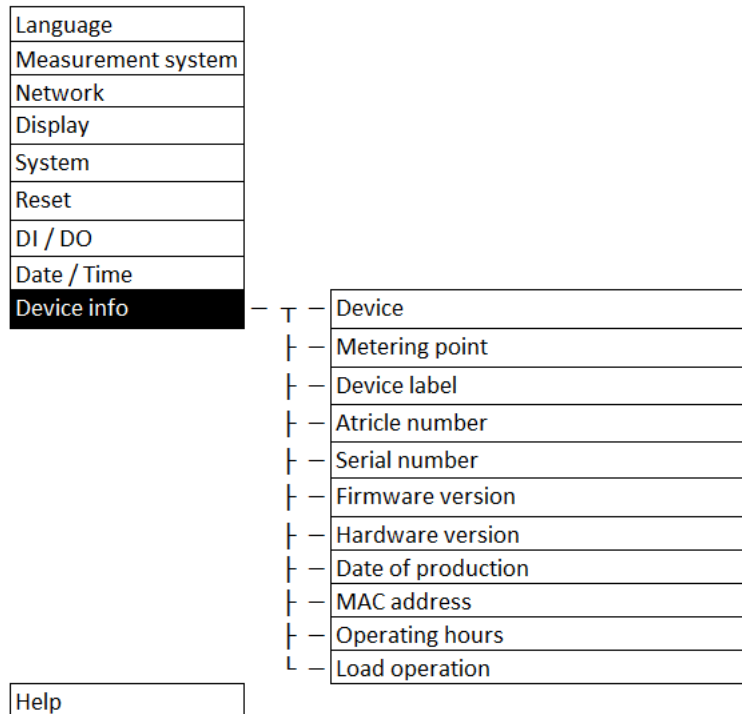

Figure 7-22 Menu "Device info"



Figure 7-23 Display "Device info"

The following device information can be read on the display:

- Hardware version
- Firmware version
- Device label
- Article number
- UUID
- Date and time of production
- Serial number

- Bootloader revision

7.5 Resetting the device to default settings

Navigation on the display "System, Factory reset"

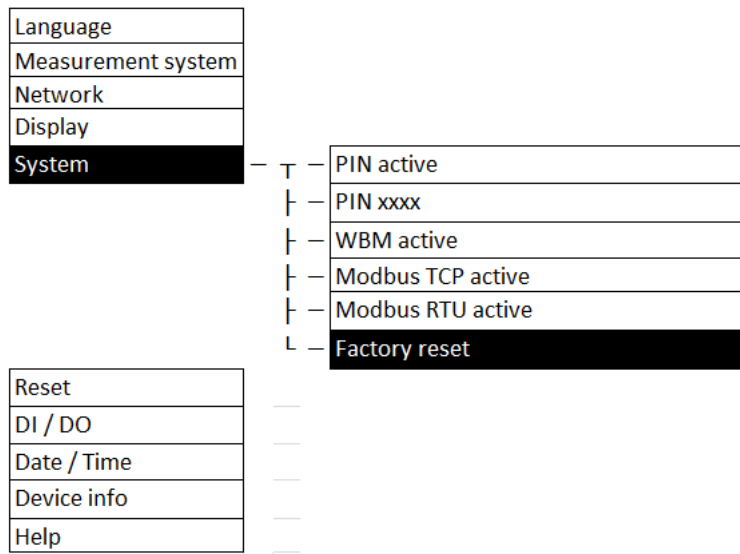

Figure 7-24 Menu: "System, Factory reset"

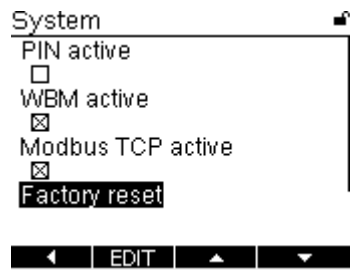

Figure 7-25 Menu: "System, Factory reset"

With the device PIN, the device can be reset to the default settings.

In the process, all configurations are lost and the device is returned to the delivery state.

8 Configuration

The device configuration is set by default as follows.

Configuration via the display

You can use the control buttons on the front of the device to enter the basic device configuration and configure settings on the display.

Configuration via web server

The web server is the tool provided for device configuration. In addition to offering intuitive operation, it has been designed for not only entering the basic device configuration, but also for performing all other configurations.

Configuration via Modbus

In addition to the web server, the Modbus communication interface can also be used for device configuration.

8.1 Access and passwords



For your own safety, change the access data.

8.1.1 Editing access data via the display

Navigation on the display

“System, PIN xxxx”

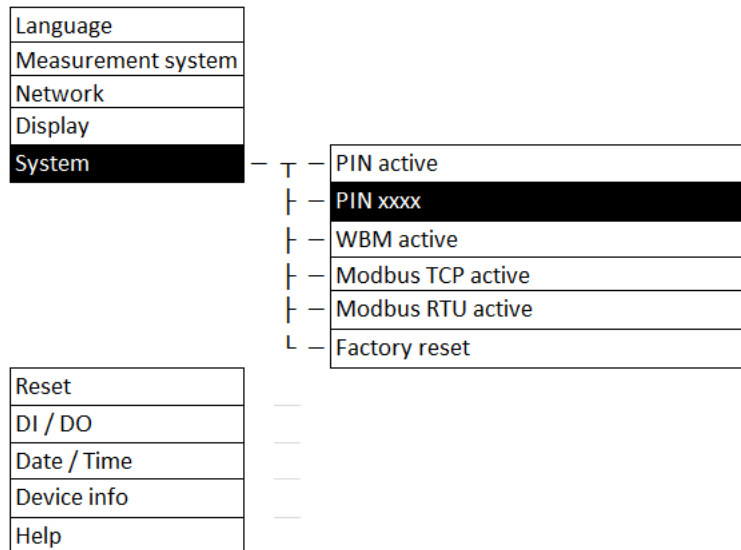

Figure 8-1 Menu: “System, PIN xxxx”

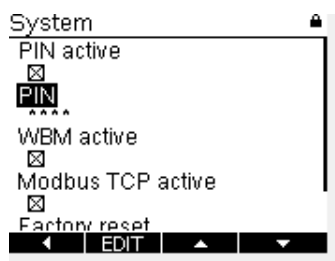

Figure 8-2 Settings: “System, PIN xxxx”

The default setting for the PIN is “0100”.

1. Under “PIN”, change the preset PIN for access permission.
2. Subsequently apply it by confirming the change.

In addition to the option to change the PIN, the device also offers an option for deactivating the PIN.

8.1.2 Editing access data via the web server

Navigation on the web server

“System, User management, Change password”

User management

The screenshot displays two sections of a web interface. The top section, titled 'Login', features a text input field labeled 'Password:' containing the text 'Logged in as admin'. To the right of this field is a teal button labeled 'Login'. The bottom section, titled 'Change password', contains two text input fields. The first is labeled 'New password:' and the second is labeled 'New password (repeat):'. Both fields have a small eye icon to their right, indicating a password visibility toggle. Below these fields is a teal button labeled 'Change password'.

Figure 8-3 Menu: “System, User management, Change password”

The default setting for the password is “adm1n”.

1. Under “Change password”, change the preset password for access permission.
2. Confirm the change by clicking the “Change password” button.

8.1.3 Deactivating the configuration via the display

Navigation on the web server "Settings, Display"

Display

Status

Standard display: IEC

Activate configuration via display:

Illumination duration: Set duration 00:00:20 hh:mm:ss

Red color change in case of error:

Discard Save

Figure 8-4 Menu: "Settings, Display"

The device provides an option for protection against manipulative access: You can prevent access to the device and thus changes to the configured data by disabling the "Activate configuration via display" checkbox.

You can continue to use the control buttons of the device to read measurement values.

If the "Activate configuration via display" checkbox is disabled, it is not possible to use the function for deactivating the web server. The display and web server cannot be deactivated simultaneously.

8.1.4 Deactivating the Modbus communication interface

You can prevent device access via the Modbus communication interface by deactivating the communication interface (“WBM active”).

Navigation on the display “System, PIN active/WBM active (web-based management)”

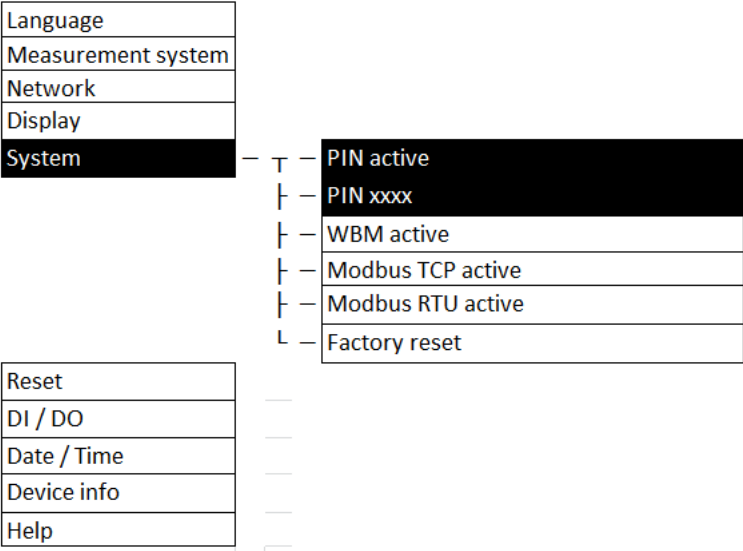

Figure 8-5 Menu: “System, PIN active/WBM active”

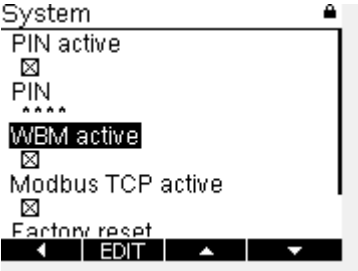

Figure 8-6 Setting: “System, WBM active”

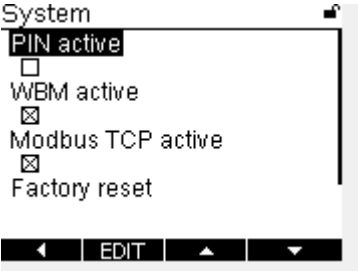

Figure 8-7 Setting: “System, PIN active”

EMpro - multi-functional energy measuring devices for front panel installation

If you disable the “WBM active” checkbox, the device no longer allows access via the communication interface.

Through this deactivation, access to the web server is also prohibited.

This precludes use of the function for deactivating the control buttons. The display and web server cannot be deactivated simultaneously.

8.2 Transferring configuration data

If you want to apply existing configurations to other devices, you can transmit the configuration data as follows:

- Exporting configuration data
- Importing configuration data
- Direct transfer of configuration data

8.2.1 Exporting configuration data

Navigation on the web server

“System, Configuration data, Export configuration”

The screenshot shows a web interface for exporting configuration data. At the top, there are three tabs: 'Transfer configuration', 'Export configuration' (which is active), and 'Import configuration'. Below the tabs, there are two buttons: 'Select all' and 'Unselect all'. A list of configuration categories follows, each with a checkbox:

- Measurement system:
- Average values:
- Tariffs:
- Logging:
- Alarming:
- Network:
- Modbus:
- Digital output:
- Digital input:
- Impulse counter:
- Date / Time:
- Identifier:
- Display:

At the bottom right of the list, there is a teal 'Download' button.

Figure 8-8 Menu “System, Configuration data, Export configuration”

If you want to export the entire device configuration, all checkboxes except the network configuration are enabled.

To perform a 1:1 device exchange, or to download an identical device configuration, click “Select all”. All checkboxes in the overview are enabled.

Another option is to perform a partial configuration by only enabling the required checkboxes. In this case, only the selected configuration is downloaded.

Press the “Download” button to download the configuration.

8.2.2 Importing configuration data

Navigation on the web server

“System, Configuration data, Import configuration”



The screenshot shows a web interface for configuration management. At the top, there are three tabs: "Transfer configuration", "Export configuration", and "Import configuration". The "Import configuration" tab is selected. Below the tabs is a file selection area with a "Choose File" button and the text "No file chosen". Below that is a blue "Import" button.

Figure 8-9 Menu: “System, Configuration data, Import configuration”

If you want to load an existing configuration file onto the device, you can use the “Choose file” button to select it.

Use the “Import” button to load the selected file onto the device.

8.2.3 Direct transfer of configuration data

Navigation on the web server

“System, Configuration data, Transfer configuration”

Transfer configuration
Export configuration
Import configuration

Select all

Unselect all

- Measurement system:
- Average values:
- Tariffs:
- Logging:
- Alarming:
- Network:
- Modbus:
- Digital output:
- Digital input:
- Impulse counter:
- Date / Time:
- Identifier:
- Display:

Device adc

password

-

Check connection

+

Transfer

Figure 8-10 Menu: “System, Configuration data, Transfer configuration”

By directly transferring the configuration data, you prevent caching on a local computer.

If you want to transfer the entire device configuration directly from one device to another, use the “Select all” button to enable all checkboxes in the overview. The network connection is not activated. If you want to include the network configuration, select it additionally.

Observe the following:

- You have to know the IP addresses and passwords of the devices.
- All devices have to be accessible via the network.

In addition to transferring the entire device configuration, you can also perform a partial transfer of the configuration by selecting the required checkboxes.

Enter the device addresses and passwords into the respective fields.

To check the connection to the entered device, click the “Check connection” button.

Click the “Transfer” button to transfer the selected configuration data to the devices.

9 Measuring technology

9.1 Meter readings

Navigation on the web server

“Home, Meter readings”

Meter readings

[Reset all](#)

Energy meter total		Energy meter		Tariff meter 1	
Ea+	0,02 k Wh	Ea+	0,00 k Wh	Deactivated	
Ea-	0,00 k Wh	Ea-	0,00 k Wh	Ea+	0,00 k Wh
Er+	0,00 k varh	Er+	0,00 k varh	Ea-	0,00 k Wh
Er-	0,00 k varh	Er-	0,00 k Wh	Er+	0,00 k varh
Es	0,02 k VAh	Es	0,00 k VAh	Er-	0,00 k varh
Reset		Reset		Reset	

Tariff meter 2		Tariff meter 3		Tariff meter 4	
Deactivated		Deactivated		Deactivated	
Ea+	0,00 k Wh	Ea+	0,00 k Wh	Ea+	0,00 k Wh
Ea-	0,00 k Wh	Ea-	0,00 k Wh	Ea-	0,00 k Wh
Er+	0,00 k varh	Er+	0,00 k varh	Er+	0,00 k varh
Er-	0,00 k varh	Er-	0,00 k varh	Er-	0,00 k varh
Es	0,00 k VAh	Es	0,00 k VAh	Es	0,00 k VAh
Reset		Reset		Reset	

Impulse counter		Operating hour counter	
Deactivated			
Imp	0,00	T_tot	132,00 h
Imp_res	0,00 kWh	T_load	0,00 h
Reset		Reset	

Figure 9-1 Menu: “Home, Meter readings”

The device provides various meter readings for measuring the energy data. These are described in the following sections.

9.1.1 Energy meters

9.1.1.1 Energy meter, total

Navigation on the display "E, Energy total"

Navigation on the display

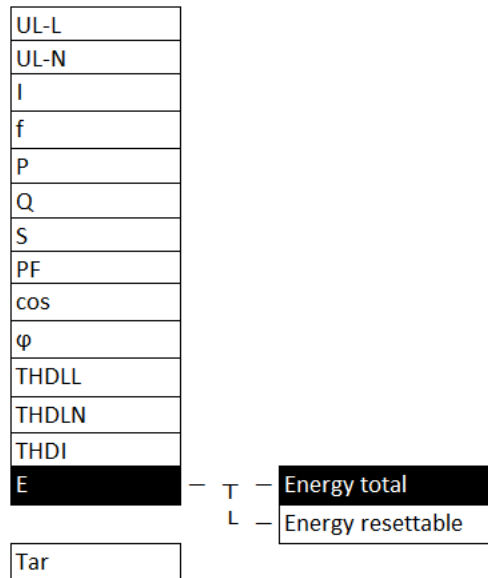

Figure 9-2 Menu: "E, Energy total"

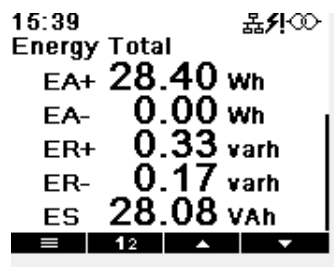

Figure 9-3 Menu: "E, Energy total"

Energy total

This energy meter is always counting.

This energy meter cannot be reset.

The following energy data is recorded:

- Active energy: supply (Ea+), consumption (Ea-)
- Reactive energy: supply (Er+), consumption (Er-)
- Apparent energy (Es)

9.1.2 Energy resettable

Navigation on the display "E, Energy resettable"

Navigation on the display

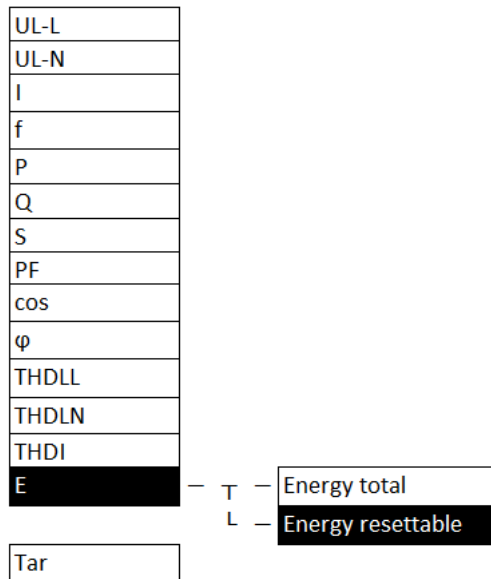

Figure 9-4 Menu: "E, Energy resettable"

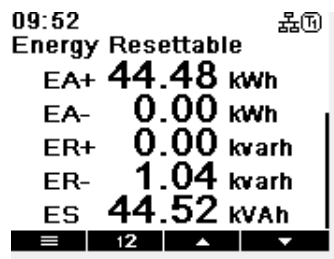

Figure 9-5 Menu: "E, Energy resettable"

Energy resettable

This energy meter is always counting. This energy meter can be reset.

Reset

The reset can be performed by means of the web server, the control buttons on the display, or the Modbus communication interface.

The following energy data is recorded:

- Active energy: supply (Ea+), consumption (Ea-)
- Reactive energy: supply (Er+), consumption (Er-)
- Apparent energy (Es)

9.1.3 Tariff meter

Navigation on the display “Tar, Tariff meter 1...4”

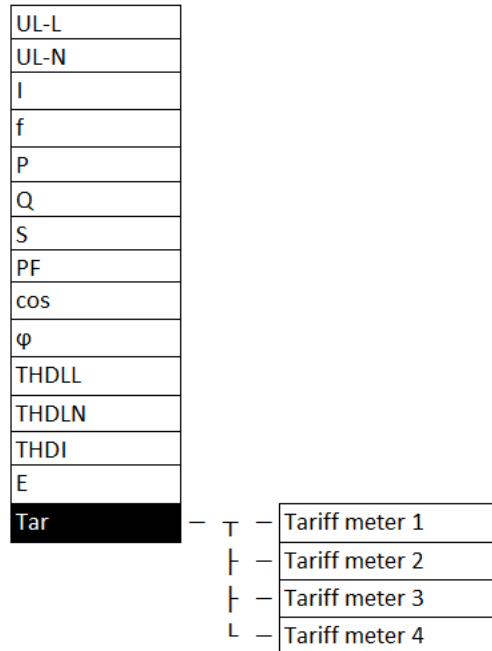

Figure 9-6 Menu: “Tar, Tariff meter 1...4”

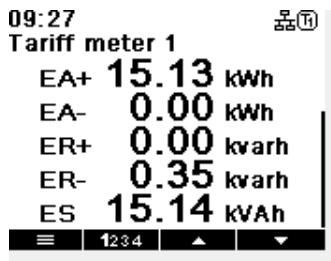

Figure 9-7 Menu: “Tar, Tariff meter 1”

Tariff meter (1...4)

If a tariff meter is selected/activated, counting is always performed on this meter. Tariff meters 1...4 can be reset.

Reset

The reset can be performed by means of the web server, the control buttons on the display, or the Modbus communication interface.

The following energy data is recorded for each tariff meter:

- Active energy: supply (Ea+), consumption (Ea-)
- Reactive energy: supply (Er+), consumption (Er-)
- Apparent energy (Es)

9.1.4 Operating hours counter

Navigation on the display "Device info, Operating hours/Load operation"

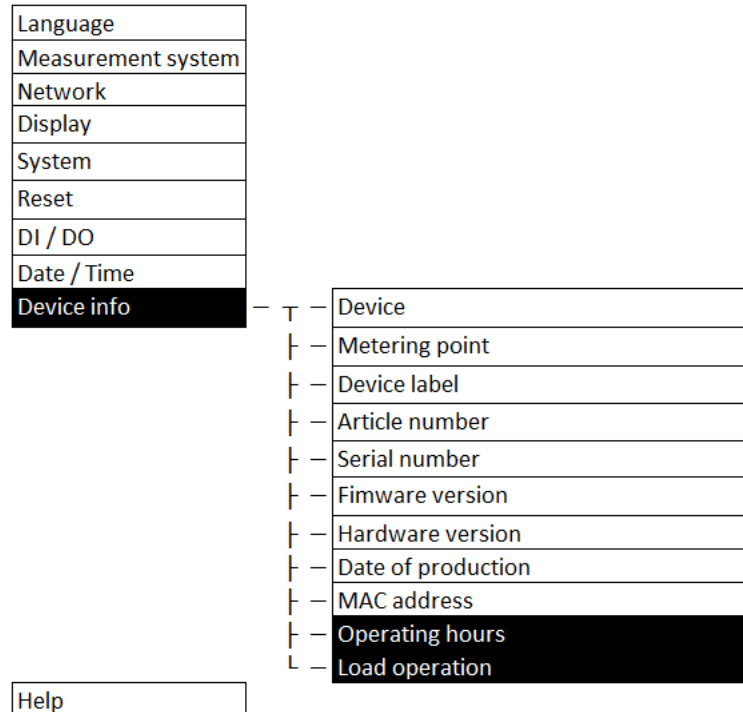

Figure 9-8 Menu: "Device info, Operating hours/Load operation"

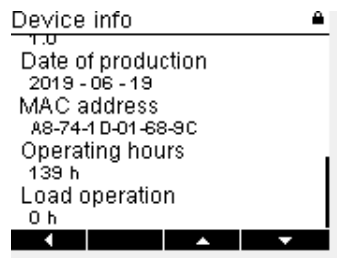

Figure 9-9 Menu: "Device info, Operating hours/Load operation"

The device provides two different operating hour counters.

Operating hours (T_tot)

This counter keeps running as long as the device is supplied with voltage.

Load operation (T_load)

This counter is a load counter that starts running from a configurable power threshold (in W). The default setting for the power threshold is 100 W. The value can be configured via the Modbus communication interface.

9.2 Statistics

9.2.1 Average values

The device makes it possible to determine average values based on the available measurement data.

The average is generated for the following measurement values:

- Voltages: phase to phase U12, U23, U31
- Voltages: phase to neutral conductor U1, U2, U3
- Frequency
- Currents I1, I2, I3, IN
- Active power: consumption, supply
- Reactive power: consumption, supply
- Apparent power

The measurement values are divided into groups. These groups can be configured independently of each other.

The following groups have been formed:

- Voltages
- Frequency
- Currents
- Power
- Predictions

For each average value, the minimum and maximum averages are always recorded and displayed. The data can be called up via the web server, the display and via the communication interface.

There are three different types of average value generation:

- AVG over fixed interval
- AVG over rolling interval
- AVG over sliding interval

The average value types are described in the following sections.

The figures show the three different types of average value calculation. Select a time interval that the measuring device will then use for calculating the average.

Navigation on the web
server

“Settings, Average values”

Average values

Status				
Parameter	Type	Interval (hh:mm:ss)	Sub periods	Digital input
Voltage	0	00:15:00	-	<input type="checkbox"/>
Current	0	00:15:00	-	<input type="checkbox"/>
Frequency	0	00:15:00	-	<input type="checkbox"/>
power	0	00:15:00	-	<input type="checkbox"/>
Prediction	0	00:15:00	-	<input type="checkbox"/>

Figure 9-10 Menu: “Settings, Average values”

Status

Here, the current status of the average value generation is shown.

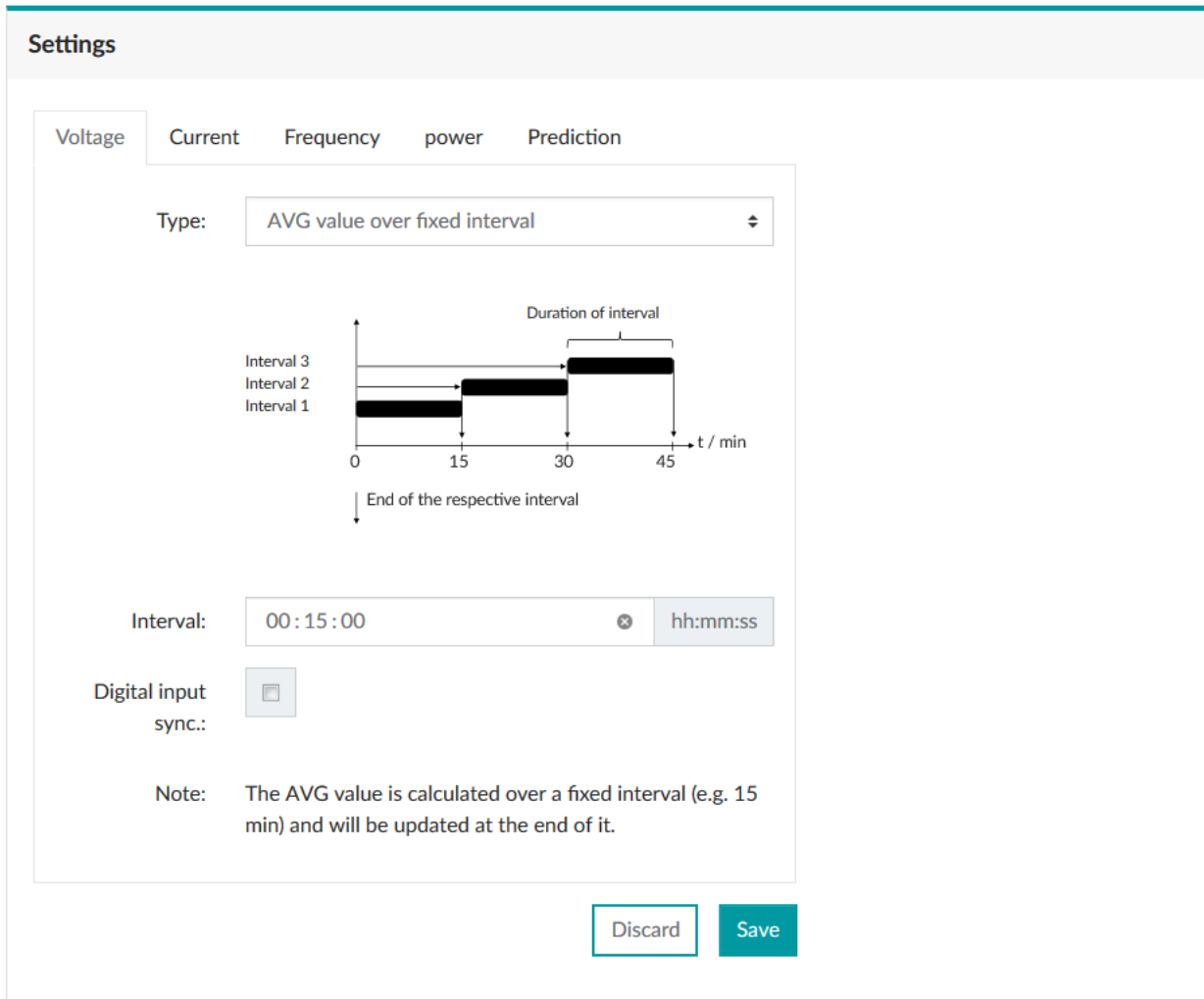

Figure 9-11 Menu: "Average values, Settings"

Settings

Here, enter the configuration in hh:mm:ss for the average value generation. If the checkbox is enabled, the average values are synchronized via the digital input.

9.2.1.1 AVG over fixed interval (fixed block)

Interval with fixed measuring interval length

The intervals follow each other consecutively at the measurement interval length. The requirement is calculated and updated at the end of each interval.

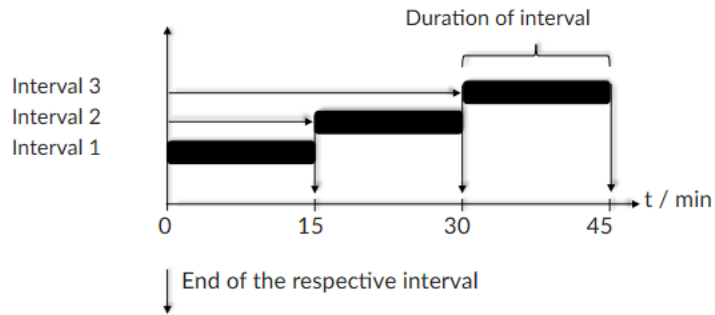

Figure 9-12 AVG over fixed interval (fixed block)

9.2.1.2 Sliding average value (sliding block)

Interval with sliding measuring interval length

The intervals slide and have a set measuring interval length. The average value is generated and updated with the sliding speed. During each update, the average is generated for the last completed interval.

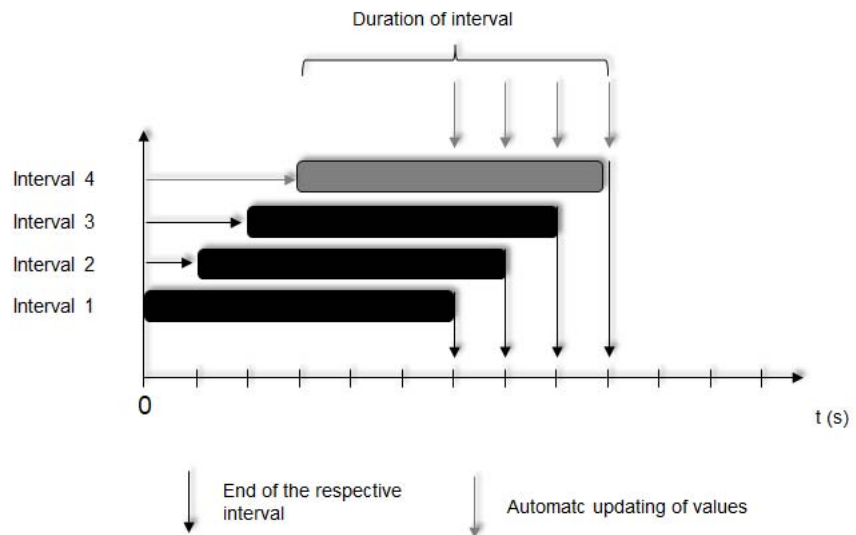

Figure 9-13 Sliding average value (sliding block)

9.2.1.3 Rolling average value (rolling block)

Interval with rolling block

There is a set interval and a subinterval. The subinterval has to be an integer factor of the interval. Example: If the selected interval is 15 minutes, three 5-minute subintervals have to be selected to match it. The average value is generated and updated at the end of each completed subinterval.

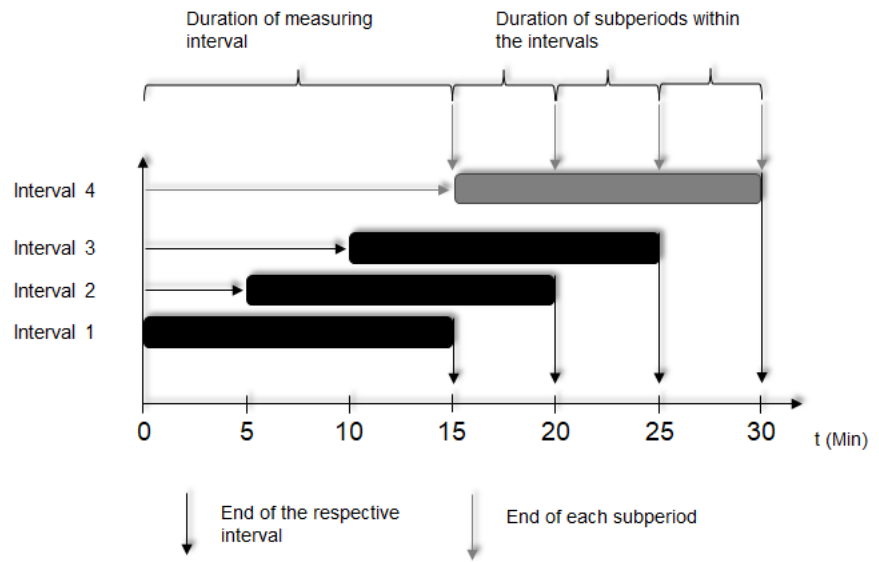

Figure 9-14 Rolling average value (rolling block)

9.2.1.4 Trend calculation (equally weighted average)

Interval with fixed measuring interval length

The intervals follow each other consecutively at the measurement interval length. All recorded individual values within the generated average values have the same valency.

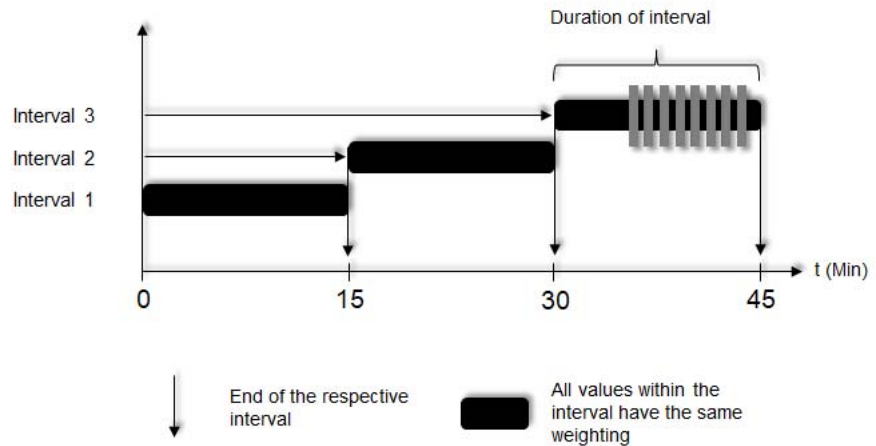

Figure 9-15 Prediction calculation (equally weighted average)

9.2.1.5 Prediction calculation (weighted average)

Interval with fixed measuring interval length

The intervals follow each other consecutively at the measurement period length. The last acquired, individual value within the generated average values has the highest valency. As each new value is recorded, the valency of the individual values decreases (exponentially).

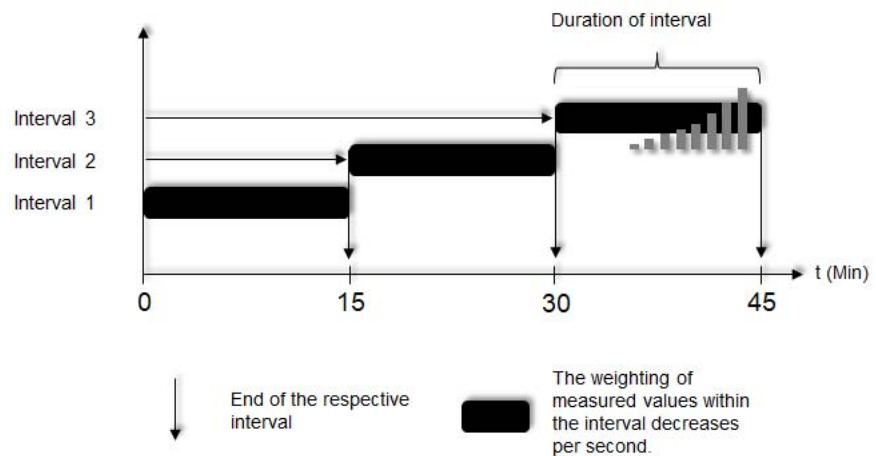

Figure 9-16 Prediction generation (weighted average)

10 Functions

10.1 Digital input

The digital input complies with IEC 61131-2 Type 3. It includes the following functions:

- Impulse counter
- Tariff selection
- Synchronization of average values
- Acknowledgment of alarms

Digital input

Status

State: Inactive

Activated:

Linked functions

Impulse counter: [Link to Impulse counter](#)

Tariffs: [Link to Tariffs](#)

Average values: [Link to Average values](#)

Alarming: [Link to Alarming](#)

Settings

Identifier:

Activate:

Figure 10-1 Digital input

Status

The “Status” area shows the current status of the digital input.

Linked functions

The digital input has been configured with a defined function.

By clicking the respective link, you can access the configuration page for the function.

Settings

An identifier can be assigned to the digital input. With the checkbox, it can be activated or deactivated.

In the default settings, the digital input is activated.

10.1.1 Impulse counter

The impulse counter counts the pulses generated by an external device.

It is possible to assign a measuring unit (volume, weight, distance, electrical power or an own unit), as well as the valency.

Navigation on the web server

“Settings, Impulse counter”

Impulse counter

The screenshot shows a web interface for configuring an impulse counter. It is split into two panels: 'Status' and 'Settings'.
Status Panel:
 - Activated:
 - Valency: 1
 - Unit: kWh
Settings Panel:
 - Activate:
 - Valency: 1 (input field with a numeric keypad icon)
 - Unit: kWh (dropdown menu)
 - Buttons: Discard, Save

Figure 10-2 Menu: “Settings, Impulse counter”

Status

The “Status” area shows the current status of the digital input.

Settings

Set the impulse counter in accordance with your requirements.

Activate

The impulse counter can be activated/deactivated with the checkbox.

Valency

The impulse corresponds to the set value and is thus an additional multiplier. The valid value range is 1 ... 65535.

Unit

Select a unit from the drop-down menu, or assign an own unit by selecting “Custom”.

Unit: You can select between the following units:

- kWh
- kVAh
- kvarh
- ml
- l
- m³
- g
- kg
- t
- m
- km
- Custom

You can use the "Custom" option to define an own unit.

10.1.2 Tariff selection

A switchover from one tariff to another can be performed via the digital input. Depending on the status of the input signal, tariff meter 1 or tariff meter 2 is used. Two of the four tariffs of the device can be used via the digital input.

Via the web server, you can manually configure up to four tariffs (identifiers 1...4) and read them via the communication interface.

Navigation on the web server

“Settings, Tariffs”

Tariffs

Status

Active: No active tariff

Settings

Identifier 1:

Identifier 2:

Identifier 3:

Identifier 4:

Mode: ▾

Digital input active: ▾

Digital input inactive: ▾

Figure 10-3 Menu: “Settings, Tariffs, Digital input”

EMpro - multi-functional energy measuring devices for front panel installation

Status	The "Status" area shows the current status of the digital input.
Settings	Set the impulse counter according to your requirements.
Identifier	Define the two identifiers (names) for your tariffs.
Mode	Specify the digital input as method for using the tariff selection.
Digital input	Define the status of the digital input in relation to the identifier.

10.1.3 Synchronization of average values

By means of the digital input, the synchronization pulse can be used for starting the respective average value generation.

Navigation on the display "UL-L, UL-L ..."

UL-L	— T —	UL-L instantaneous
	—	UL-L min
	—	UL-L max
	L —	UL-L AVG
		UL-L AVG min
		UL-L AVG max

Figure 10-4 Menu: "UL-L"

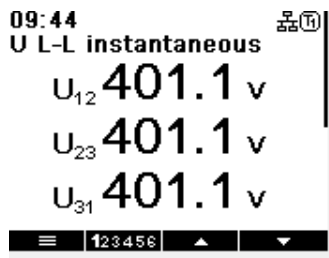

Figure 10-5 Menu: "UL-L, UL-L instantaneous" (instantaneous values, instantaneous)

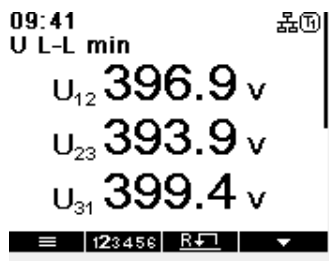

Figure 10-6 Menu: "UL-L, UL-L min" (minimum values, min)

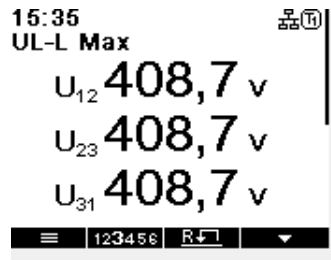

Figure 10-7 Menu: "UL-L, UL-L max" (maximum values, Max)

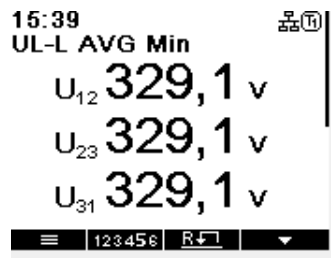

Figure 10-8 Menu: "UL-L, UL-L AVG min" (minimum average values, AVG Min)

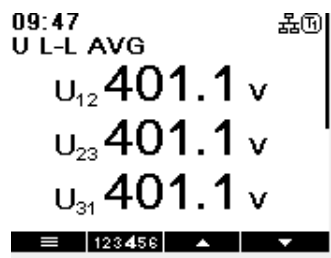

Figure 10-9 Menu: "UL-L, UL-L AVG" (average values, AVG)

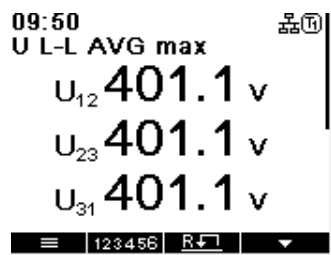

Figure 10-10 Menu: "UL-L, UL-L AVG max" (maximum average values, AVG max)

Navigation on the web server

“Settings, Average values”

Average values

Status				
Parameter	Type	Interval (hh:mm:ss)	Sub periods	Digital input
Voltage	0	00:15:00	-	<input type="checkbox"/>
Current	0	00:15:00	-	<input type="checkbox"/>
Frequency	0	00:15:00	-	<input type="checkbox"/>
power	0	00:15:00	-	<input type="checkbox"/>
Prediction	0	00:15:00	-	<input type="checkbox"/>

Figure 10-11 Menu: “Settings, Average values, Status”

The digital input can be used to synchronize the average value generation. This function is used, e.g., when energy requirements have been defined that are not to be exceeded.

When the average values are not synchronized, the measuring results might not correspond to the relevant energy requirements.

10.1.4 Acknowledgment of alarms

In most applications, configured alarms that occur in the event of an error in the application are self-acknowledging. After the error status has been restored to the normal status (operation) of the applications, the alarm message disappears again.

You can save an error status in the application until it is manually reset via the digital input.

10.2 Digital output

The digital output complies with IEC 61131-2 Type 3. It can be configured via the web server or the Modbus communication interface.

Navigation on the web server

“Settings, Digital output”

Digital output

Status

State: Inactive Aktivieren

Settings

Identifier:

Idle level: Normally closed (NC) Normally open (NO)

1
0

Function:

Discard Save

Figure 10-12 Menu: “Settings, Digital output”

Status

The “Status” area shows the current status of the digital output.

Identifier

The identifier can be used to assign a user-specific designation to the digital output.

Idle level

There are two possible statuses for the idle level.

- NC: Normally closed
- NO: Normally open

The default setting for the digital output is NC (normally closed).

Only one function can be configured at a time.

- Impulse
- Device status
- Manual
- Alarm
- Rotary field direction
- Deactivated

The digital output is deactivated by default.

10.2.1 Impulse

Navigation on the web server

“Settings, Digital output”, “Impulse” function

Digital output

Status

State: Inactive

Settings

Identifier:

Idle level: Normally closed (NC) Normally open (NO)

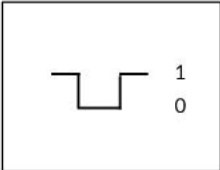

Function:

Electrical parameter:

Valency: 1 kWh

Impulse duration: ms

Figure 10-13 Menu: “Settings, Digital output”, “Impulse” function

With the "Impulse" function, the following electrical parameters can be transmitted to a higher-level evaluation unit:

- Active energy (positive, negative)
- Reactive energy (positive, negative)
- Apparent energy

Other configuration parameters are:

Valency

The impulse corresponds to the set value.

The valid value range is 0.01 ... 655.35 in kWh.

Impulse duration

The valid value range is 30 ... 900 in ms.

10.2.2 Device status

The “Device status” function can be used to check whether the device is on or off.

Here, it is also possible to define whether the output is normally closed (NC) or normally open (NO) in idle state.

Navigation on the web server

“Settings, Digital output”, “Device status” function

Digital output

Status

State: Active

Settings

Identifier:

Idle level: Normally closed (NC) Normally open (NO)

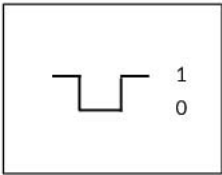

Function:

Figure 10-14 Menu: “Settings, Digital output”, “Device status” function

Status	The "Status" area shows the current status of the digital output.
Identifier	The identifier can be used to assign a user-specific designation to the digital output.
Idle level	<p>There are two possible statuses for the idle level.</p> <ul style="list-style-type: none">– NC: Normally closed– NO: Normally open <p>The default setting for the digital output is NO.</p>

10.2.3 Manually

With the “Manually” function, the digital output can be enabled and disabled via the Modbus communication interface. Here, you also have to define whether the output is normally closed (NC) or normally open (NO) in idle state.

Navigation on the web server

“Settings, Digital output”, “Manually” function

Digital output

The screenshot displays the 'Digital output' configuration interface. It is divided into two main sections: 'Status' and 'Settings'.
In the 'Status' section, the current state is 'Inactive', and there is a teal 'Aktivieren' button to activate it.
The 'Settings' section contains:
- An 'Identifier' text input field containing 'DO'.
- 'Idle level' radio buttons for 'Normally closed (NC)' and 'Normally open (NO)', with 'Normally open (NO)' selected.
- A logic diagram showing a pulse signal with levels 1 and 0.
- A 'Function' dropdown menu currently set to 'Manually'.
- 'Discard' and 'Save' buttons at the bottom right.

Figure 10-15 Menu: “Settings, Digital output”, “Manually” function

Status

The “Status” area shows the current status of the digital output.

Identifier

The identifier can be used to assign a user-specific designation to the digital output.

Idle level

There are two possible statuses for the idle level.

- NC: Normally closed
- NO: Normally open

The default setting for the digital output is NO.

10.2.4 Alarm

The "Alarm" function can be used to react to changes to the measurement values.

You can define upper and lower thresholds for the domain.

If the measured values are outside of these thresholds, the alarm function is activated and sent via the digital output.

Navigation on the web server

Menu: "Settings, Digital output", "Alarm" function

Digital output

Status

State: Inactive

Settings

Identifier:

Idle level: Normally closed (NC) Normally open (NO)

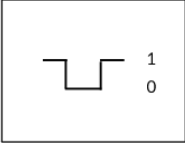

Function:

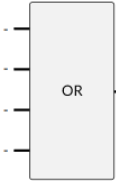

Alarm 1: Invert

Alarm 2: Invert

Alarm 3: Invert

Alarm 4: Invert

Logic gate:

Figure 10-16 Menu: "Settings, Digital output", "Alarm" function

- Status** The “Status” area shows the current status of the digital output.
- Identifier** The identifier can be used to assign a user-specific designation to the digital output.
- Idle level** There are two possible statuses for the idle level.
 - NC: Normally closed
 - NO: Normally open
- Function** Select the “Alarm” function.

Navigation on the web server “Settings, Alarm”

Alarming

Status							
Identifier	Data source	Low limit	High limit	Delay	Hysteresis	Self cleared	State
Alarm 1	U12	390,00	410,00	1 s	5 %	<input checked="" type="checkbox"/>	Ok
Alarm 2	F	-	-	1 s	5 %	<input checked="" type="checkbox"/>	Ok
Alarm 3	F	-	-	1 s	5 %	<input checked="" type="checkbox"/>	Ok
Alarm 4	F	-	-	1 s	5 %	<input checked="" type="checkbox"/>	Ok

Confirm

Figure 10-17 Menu: “Settings, Alarm, Status”

Status The “Status” area shows the current status of the alarms.

Settings

Set the alarm according to your requirements.

The screenshot displays the 'Settings' menu for an alarm. At the top, there is a checkbox labeled 'Confirm with digital input' which is checked. Below this are four text input fields for 'Identifier 1' through 'Identifier 4', each containing the text 'Alarm 1' through 'Alarm 4' respectively. A tabbed interface below shows four tabs: 'Alarm 1', 'Alarm 2', 'Alarm 3', and 'Alarm 4'. The 'Alarm 1' tab is selected and contains the following configuration options: 'Data source' is a dropdown menu set to 'U12'; 'High limit' has a checked checkbox and a 'Limit value' of 410; 'Low limit' has a checked checkbox and a 'Limit value' of 390; 'Delay' is a text input field with '1' and a unit selector 's'; 'Hysteresis' is a text input field with '5' and a unit selector '%'; and 'Self cleared' has a checked checkbox. At the bottom right of the form are two buttons: 'Discard' and 'Save'.

Figure 10-18 Menu: "Settings, Alarm"

Confirm with digital input You can use the checkbox to define that manual acknowledgment of an alarm is required. The acknowledgment is performed via the digital input, which has to be configured for this purpose.

Identifier) The identifier can be used to assign a user-specific designation to the alarms.

Alarm 1...4 You can use the four tabs to define the alarm configuration for each alarm.

Data source Select the measurement value to be monitored.

High limit and low limit Use the checkbox to select the monitoring function. Depending on which function you selected, enter the value to be monitored.

Delay Enter the tripping delay for the alarm in seconds.

Hysteresis For the switching threshold, a hysteresis in percent is required. Enter it here.

Self-cleared

With this checkbox, you can define that the alarm self-acknowledges after the normal status has been restored. This way, no manual acknowledgment via the digital input is required.

The integrated logic gate enables multiple use of the digital output for the alarm function.

10.2.5 Rotary field direction

The recognition of the rotary field direction is used to inform the digital output about the state of the application. The rotary field direction can be configured for both directions (left, right).

Navigation on the web server

“Digital output, Settings, “Rotary field direction” function

Digital output

Status

State: Inactive

Settings

Identifier:

Idle level: Normally closed (NC) Normally open (NO)

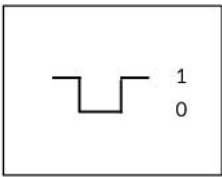

Function:

Rotary field direction: Left Right None

Figure 10-19 Menu: “Digital output, Settings, “Rotary field direction”

Status	The “Status” area shows the current status of the alarms.
Settings	Set the alarm according to your requirements.
Identifier	The identifier can be used to assign a user-specific designation to the function.
Idle level	There are two possible statuses for the idle level. <ul style="list-style-type: none">– NC: Normally closed– NO: Normally open The default setting for the digital output is NO.
Function	Select the “Rotary field direction” function from the drop-down menu.
Rotary field direction	Select the appropriate rotary field direction.

10.2.6 Deactivating the digital output

The digital output can be deactivated, so that no function is assigned to it.

Navigation on the web server

“Digital output, Settings“, “Deactivated” function

Digital output

Status

State: Inactive

Settings

Identifier:

Idle level: Normally closed (NC) Normally open (NO)

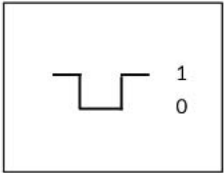

Function:

Figure 10-20 Menu: “Digital output, Settings“, “Deactivated” function

Status

The “Status” area shows the current status of the digital output.

Settings

Set the digital output according to your requirements.

Identifier

The identifier can be used to assign a user-specific designation to the function.

Idle level

There are two possible statuses for the idle level.

- NC: Normally closed
- NO: Normally open

The default setting for the digital output is NO.

Function

Select the "Deactivated" function from the drop-down menu.

10.3 Tariff selection

Navigation on the display "Tar, Tariff meter 1...4"

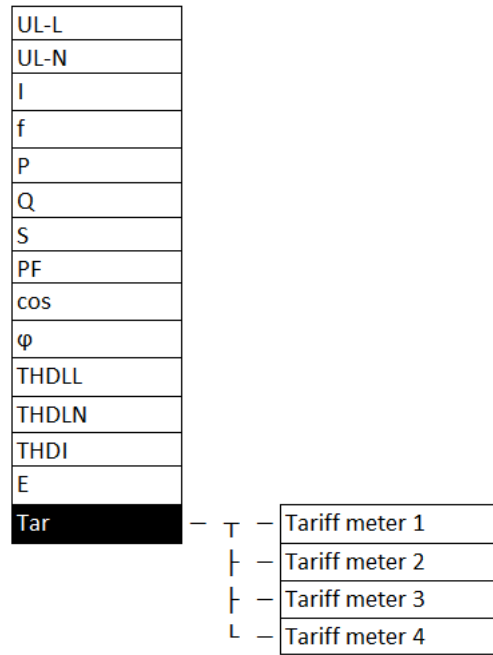

Figure 10-21 Menu: "Tar, Tariff meter"

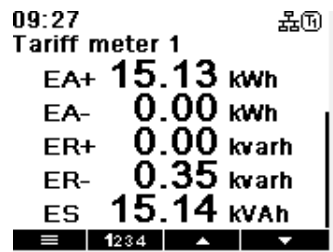

Figure 10-22 Menu: "Tar, Tariff meter 1"

The device offers various options for selecting between up to four tariffs. The following procedures are possible:

- Using the digital input: 2 tariffs can be used
- Using manual switching via a communication interface: 4 tariffs can be used
- Using a time schedule: 4 tariffs can be used

10.3.1 Tariff selection via the communication interface

The individual tariffs can also be selected via the Modbus communication interface. With the addresses in the register tables, a user-specific usage of all tariff meters can be defined, which is configured completely by means of the controller.

Navigation on the web server

“Tariffs, Settings”

Tariffs

Status

Active: No active tariff

Settings

Identifier 1:

Identifier 2:

Identifier 3:

Identifier 4:

Mode: ⌵

Tariff meter: ⌵

Figure 10-23 Menu: “Tariffs, Settings”

- Status** The “Status” area shows the current status of the tariff function.
- Settings** Configure the tariff selection according to your requirements.
- Identifier** Define the identifiers for your tariffs.
- Mode** Set the mode to “Manually”.
- Tariff meter** Select the desired tariff from the drop-down menu.

10.3.2 Tariff selection using a time schedule

The individual tariffs can also be selected by using time control. A custom application can be configured using a configurable time.

The switchover to the respective tariff meter thus purely depends on the time.

Navigation on the web server

“Tariffs, Settings”

Settings

Identifier 1:

Identifier 2:

Identifier 3:

Identifier 4:

Mode: ▾

Station profile 1

Station profile 2

Tariff 3

Tariff 4

Days: **Su Mo Tu We Th Fr Sa**

From:

Until:

Note: Monday from 08:00 until 14:00 o'clock.
 Tuesday from 08:00 until 14:00 o'clock.
 Wednesday from 08:00 until 14:00 o'clock.
 Thursday from 08:00 until 14:00 o'clock.
 Friday from 08:00 until 14:00 o'clock.

Figure 10-24 Menu: “Tariffs, Settings”

- Status** The “Status” area shows the current status of the tariff function.
- Settings** Configure the tariff selection according to your requirements.
- Identifier** Define the identifiers for your tariffs.
- Mode** Set the mode to “Time controlled”.

EMpro - multi-functional energy measuring devices for front panel installation

Tariff meter

Select the desired tariff from the drop-down menu.

Depending on the number of tariffs, you can configure the individual tabs for the tariffs.

Days

Use the checkboxes to select the days of the week.

From/Until

Enter the times for using the tariffs as appropriate for your application.



In the appendix, the configured weekdays and times are shown.

10.4 Logic gate

The integrated logic gate makes it possible to define several alarm messages for the alarm function of the digital output. The digital output can be used for this type of multiple assignment, depending on up to four alarms/thresholds.

Navigation on the web server

“Digital output, Settings”, “Alarm” function

Digital output

Status

State: Inactive

Settings

Identifier:

Idle level: Normally closed (NC) Normally open (NO)

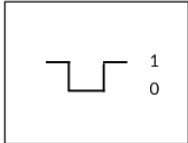

Function:

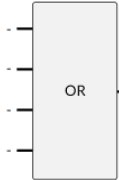

Alarm 1: Invert

Alarm 2: Invert

Alarm 3: Invert

Alarm 4: Invert

Logic gate:

Figure 10-25 Menu: "Settings, Digital output", "Alarm" function

Alarm 1...4:

Select the alarms that are to be linked to the logic gate. You can use the checkbox to invert the signal.

Logic gate

An operator has to be defined for the function of the logic gate.

Select a logic operator from the drop-down menu:

- AND
- OR
- XOR
- NAND
- NOR
- NXOR

The alarms themselves are configured via "Settings, Alarms".

Function description of the logic gate

The logic gate links configured statuses of the respective alarms with an assigned logic function. Various application-specific statuses can be monitored, depending on how the connections are combined.

Below, you can find explanations on how the logic operators work:

AND operator

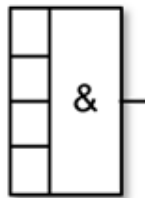

Figure 10-26 Logic gate with AND operator

When all alarms are active at the same time, this signal output is set.

If one of the alarms is no longer active, this signal output is reset.

NAND operator



Figure 10-27 Logic gate with NAND operator

When none of the alarms are active, this signal output is set.

If one of the alarms is active, this signal output is reset.

OR operator

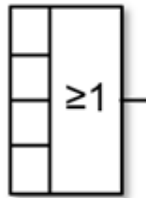

Figure 10-28 Logic gate with OR operator

When one of the alarms is active, the signal output is set.
If none of the alarms are active, this signal output is reset.

NOR operator

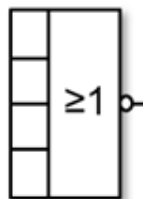

Figure 10-29 Logic gate with NOR operator

When none of the alarms are active, this signal output is set.
If one of the alarms is active, this signal output is reset.

XOR operator

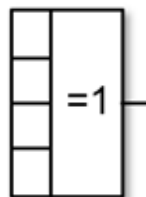

Figure 10-30 Logic gate with XOR operator

If an alarm is active, this signal output is set.
If none or several of the alarms are active, this signal output is reset.

NXOR operator

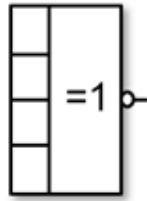

Figure 10-31 Logic gate with NXOR operator

If none or several of the alarms are active, this signal output is set.

If only one of the alarms is active, this signal output is reset.

10.5 Data logging

Logging



Status					
No.	State	Data source	Interval	Circular buffer	Control
1	◦ ◆ ◦	I1	5 min	<input type="checkbox"/>	
2	◦ ◆ ◦	U1	5 min	<input type="checkbox"/>	
3	◦ ◆ ◦	P1	5 min	<input type="checkbox"/>	
4	—				
5	—				
6	—				
7	—				
8	—				

Figure 10-32 Menu: "Logging"

Status

The "Status" area shows an overview of the current logging data.

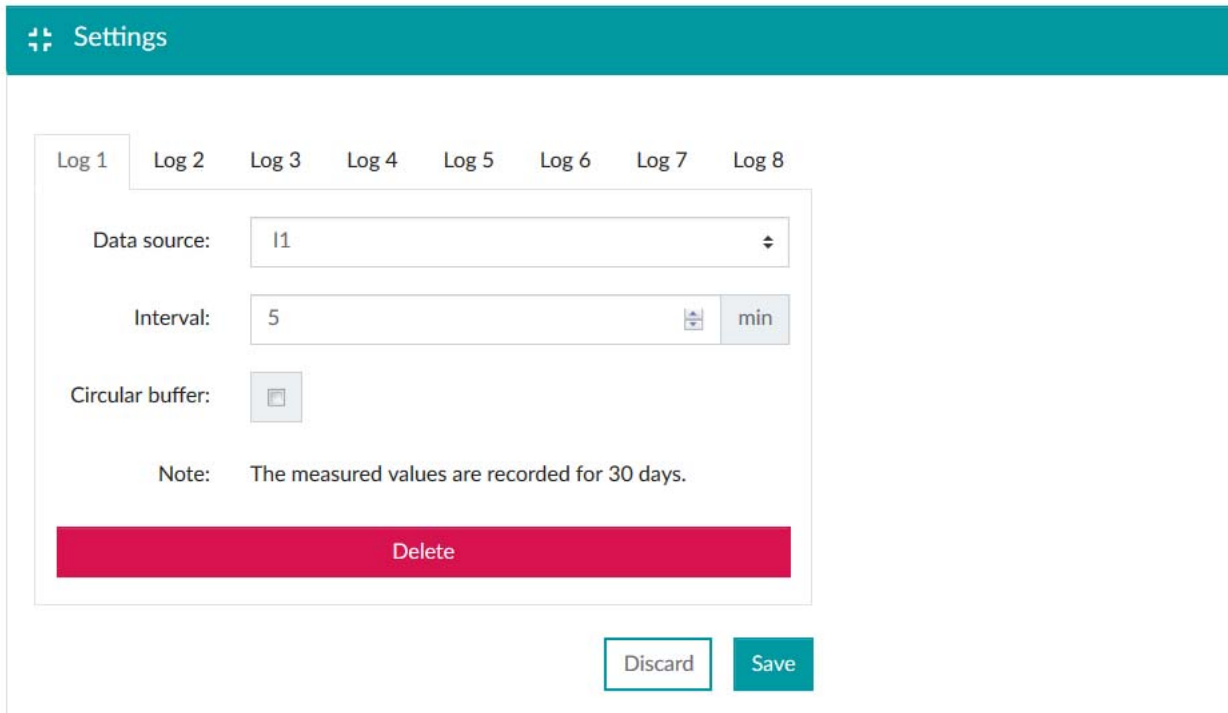

Figure 10-33 “Menu: Logging, Settings”

Log 1...8

Here, you can configure up to eight different logging parameters.

Data source

Select the desired electrical parameter for the logging from the drop-down menu.

Interval

Enter the interval time in minutes. The shortest duration that can be set is 1 minute.

The maximum logging duration depends on the configured interval. For an interval of 15 minutes, the logging capacity is approx. 90 days. If you shorten the interval, the logging capacity is also reduced (e.g., 10 minute interval/60 days logging capacity).

Circular buffer

Activate the circular buffer if you want to use the FIFO principle (first-in/first-out) for the data logging.

Deactivate the circular buffer if you want to define a fixed starting point.

The logging automatically stops once the memory is full.

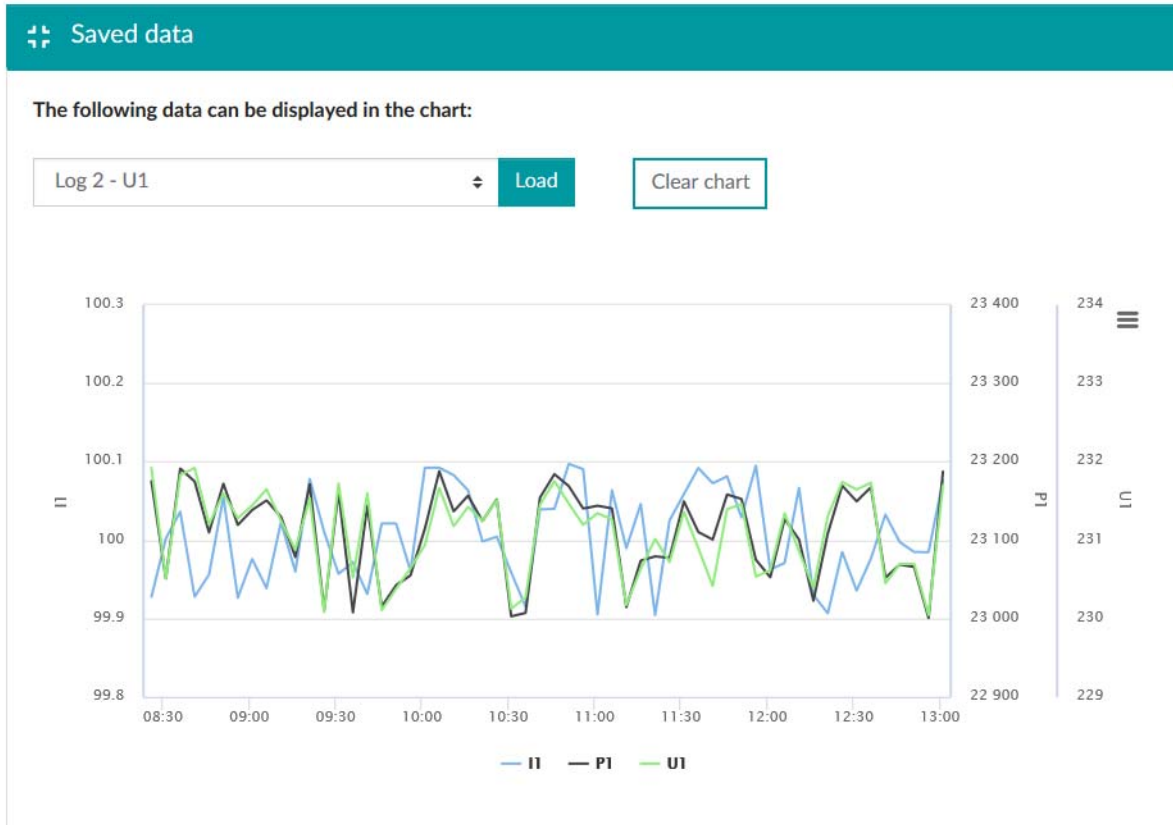

Figure 10-34 Menu: "Logging, Saved data"

You can view all configured logging data as a chart in the web server.

To do so, select the desired logging data from the drop-down menu.

With your mouse, you can zoom in on the saved data.

By means of the selection box to the right next to the chart, you can also export the logging data as CSV, XLS or PDF file.

10.6 Firmware update

The device provides a function for updating the firmware. New versions can contain bug fixes, optimize the performance and expand the functionality.

Update files are provided by Phoenix Contact GmbH & Co. KG. The respective update containers can be downloaded from the product-specific pages at phoenixcontact.com.

10.6.1 Execution

Firmware

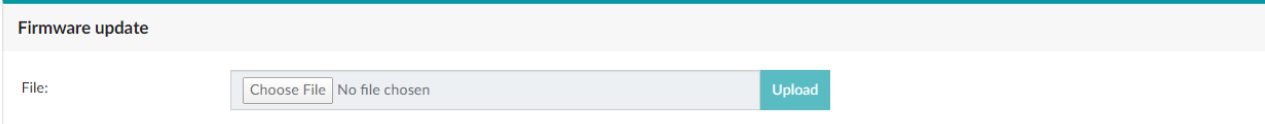

The screenshot shows a web interface for firmware updates. At the top, there is a header "Firmware update". Below it, there is a form with a "File:" label, a "Choose File" button, a text field containing "No file chosen", and an "Upload" button.

Figure 10-35 Execution of a firmware update

Firmware update

In this area, you can load a new firmware update onto the device. To perform the update, you need administrator rights.

An update can only be performed via the web server of the device.

File

Upload the new firmware file. Click the "Upload" button to begin the process.

Firmware

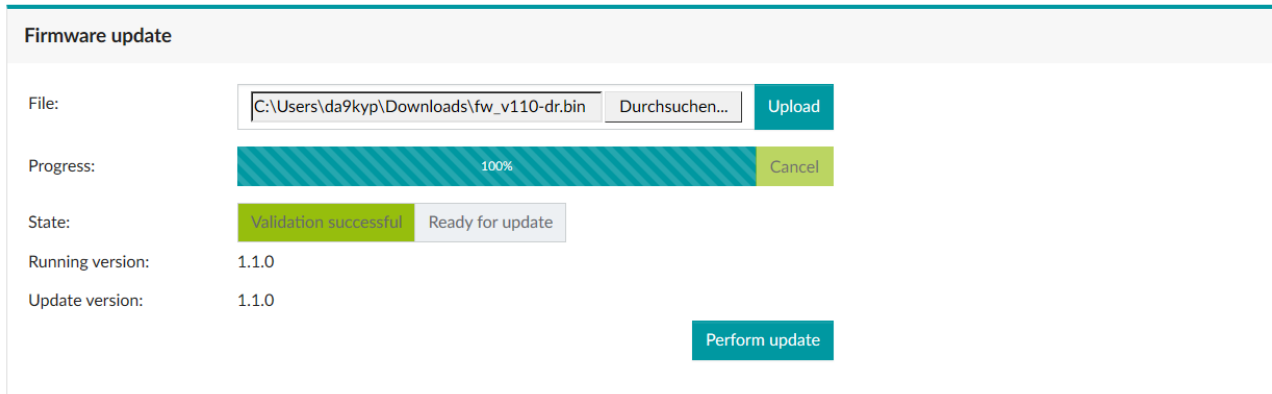

Figure 10-36 Progress and state

Progress and state

Once the firmware file has been uploaded, you can start the update on the device by clicking "Perform update".

Observe the following when performing a firmware update:

- The update process can take several minutes and should not be interrupted.
- Do not exit the subpage for updating the firmware of the web-based management.
- During the update process, the device restarts and is thus unavailable for a certain period of time.
- During certain steps of the update process, it is possible that the energy meters of the system are stopped.

10.6.2 Security

Executing a firmware update requires read access to the system. Since execution is only possible via the web server, the access is password-protected.

The update file is protected against manipulation. The system detects and rejects manipulated update files.

The update process is safeguarded against unintentional interruption or failure. An executable firmware version is always retained on the system.

11 Communication

All devices are equipped with an Ethernet interface with an RJ45 socket.

Other communication interfaces can also be available optionally.

- RS-485
- PROFINET
- EtherNet/IP™

11.1 Ethernet

All device versions are Ethernet-capable via an RJ45 interface. The devices support 10/100 Mbit full/half duplex. It is recommended to use at least Cat.5 cables (EIA/TIA-568) for installation.

11.1.1 IP addressing

The EMpro devices can be assigned both a static and a dynamic IP configuration.

Current devices support IPv4.

In the delivery state, the devices use a static IP configuration with the following parameters:

Table 11-1

IP address	192.168.1.2
Subnet mask	255.255.255.0
Default gateway	0.0.0.0
DNS server	0.0.0.0

The entry IP 0.0.0.0, e.g., for the default gateway, indicates that no default gateway has been configured.

When the dynamic IP assignment is used, the device receives its IP configuration via the DHCP protocol from another DHCP server in the same network.

11.1.2 Configuration of the communication interface

You can adapt the following parameters of the network interface:

Table 11-2 Adaptable parameters of the network interface

Function	Information	Web server	Display	Register
Mode	The mode is used to define whether a static IP configuration from the device memory has to be used, or a dynamic configuration should be performed via DHCP instead.	x	x	x
IP address	This setting is only used in static mode. Here, the static IP address of the device is configured. In dynamic mode, this parameter is supplied by the DHCP server.	x	x	x
Subnet mask	This setting is only used in static mode. Here, the static subnet mask of the device is configured. In dynamic mode, this parameter is supplied by the DHCP server.	x	x	x
Default gateway	This setting is only used in static mode. Here, the static IP address of the default gateway to be used is configured. In dynamic mode, this parameter is supplied by the DHCP server. The default gateway is required to allow communication across network boundaries. This is defined by means of the subnet mask.	x	x	x
DNS server	This setting is only used in static mode. Here, the static IP address of the DNS server to be used is configured. In dynamic mode, this parameter is supplied by the DHCP server. The DNS server is used to perform name resolutions, e.g., for an NTP time server.	x	x	x
Device name	The device supports the NetBios name service. With this protocol, the device can be addressed using a host name, without knowing the IP address of the device. The device has three NetBios names. Two of these names are manufacturer-specific and cannot be modified. You can change the third name. The following names have been defined: First manufacturer-specific NetBios name: <DEVICE_NAME> (e.g., EEM-MA770) Second manufacturer-specific NetBios name: eem<SERIAL_NUMBER> (e.g., eem1234567890) User-specific NetBios name: <YOUR_DEVICE_NAME> (default: <DEVICE_NAME>)	x	x (read only)	x

11.1.3 Status of the communication interface

If the network interface is ready, this is indicated by the  icon on the display.

The following conditions must be met for the network interface to be ready:

- Device start completed
- Network link established
- IP configuration valid
 - Always true for static configurations
 - True for dynamic configurations after the IP configuration has been received by the DHCP server

The current status of the network interface can be viewed via the WBM, the display and Modbus.

There are two LEDs on the RJ45 socket:

- Green LED for link status, to the left of the RJ45 connector
- Green LED for sending activity, to the right of the RJ45 connector

11.1.4 Security

The users are responsible for securing their networks against unauthorized access.

Up to four clients can access the interface simultaneously.

11.2 Modbus

11.2.1 Function

The Modbus protocol defines both a protocol on the application layer and a transmission protocol. The application layer protocol is identical for all interface versions. The differences between Modbus/TCP and Modbus/RTU lie in the transmission protocol.

On the application layer, Modbus supplies a 16-bit address space that can be used to address 16-bit registers. Using various function codes, read and write operations can be performed on registers.

For detailed information about the Modbus specification refer to www.modbus.org/.

The EMpro supports the following function codes:

- 03 (0x03) Read holding registers
- 04 (0x04) Read input registers
- 06 (0x06) Write single register
- 16 (0x10) Write multiple registers

Here, it has to be noted that the device does not differentiate between holding and input registers. Both function codes return the same registers.

11.2.2 Modbus/RTU

In the case of Modbus/RTU, the Modbus application layer protocol is supplemented with additional information and physically sent via an RS-485 interface. The start and end of a Modbus message is coordinated by means of timings.

Modbus/RTU describes a master/slave protocol. Here, the EMpro acts as Modbus/RTU slave. An exception here is the gateway mode.

The additional information consists of a byte for addressing the device. Valid device addresses are in the range from 1-247.

The default setting for the devices is address 1. Address 0 is reserved for broadcast messages in the network and cannot be assigned as an address to a device.

According to the specification, addresses 248-255 are reserved and cannot be assigned to the device either.

A cyclic redundancy check (CRC) is attached to the Modbus message as additional information. The CRC is used to detect transmission errors. The calculation and the polynomial used are documented in the Modbus specification.

The Modbus/RTU protocol is supported by all EMpro versions with an RS-485 interface.

11.2.2.1 Topology

The smallest network via RS-485 (Modbus) that makes sense consists of two devices:

- 1 x master 1 x slave
The typical limit is 32 devices.
- 1 x master 31 x slaves

The largest network via RS-485 (Modbus) that makes sense consists of 248 devices, because of the addressing:

- 1 x master 247 x slaves

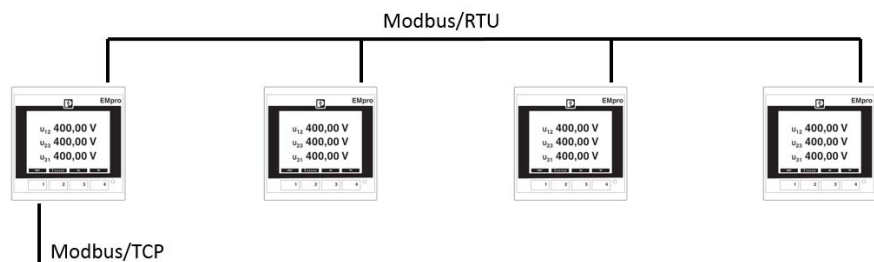

Figure 11-1 Topology

11.2.2.2 Using connections and designations

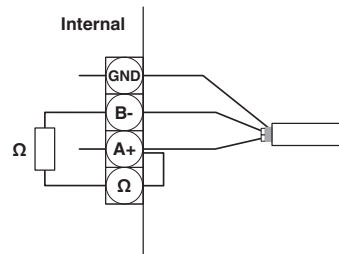

Figure 11-2 Connections and designations

The RS-485 interface has four assigned terminals.

GND:	Shield of signal line
B- and A+:	Signal lines
Ω:	120 Ω resistor

The non-inverted signal can have the following designations: A, +, A+, TxD+/RxD+, D+

The inverted signal can have the following designations: B, -, B-, TxD-/RxD-, D-

To ensure that the communication is guaranteed even in the event of malfunctions, ensure that the following conditions are met in the RS-485 network:

- Twisted pair conductors (A and B) (stranding)
- Shielded conductors (GND)
- Termination resistors (and a bias network)

NOTE: If you want to activate the integrated 120 Ω resistor, bridge the terminals Ω and A+.

11.2.2.3 Parameters for using Modbus via RS-485

Modbus

Status	
Modbus TCP	<input checked="" type="checkbox"/>
activated:	
Modbus RTU	<input checked="" type="checkbox"/>
activated:	
Address:	1
Master gateway:	<input type="checkbox"/>
Baudrate:	9600
Stop bits:	1
Parity:	None

Figure 11-3 Modbus status

Status

The “Status” area gives an overview of the current Modbus configuration.

Settings

Activate Modbus TCP:

Activate Modbus RTU:

Address:

Master gateway:

Baudrate: baud

Stop bits:

Parity:

Figure 11-4 Modbus settings

Please observe the following:

- Each slave is assigned an address between 1 and 247.
- Each address is used only once.
- There is only one master per RS-485 network.
- All devices use the same parameters for the baud rate, stop bits and parity.

You can configure the following parameters that are supported by the RS-485 interface:

- Baud rates: 2400, 4800, 9600, 19200, 38400, 57600 and 115200 bps
- Stop bits: 1, 2
- Parity: even, odd, none

The parameters can also be set via Modbus/TCP.

11.2.3 Modbus/TCP

In the case of Modbus/TCP, a special header (Modbus Application Header [MBAP]) is prefixed to the Modbus message. This Modbus/TCP message is then transmitted via an IP-based network in a TCP frame.

The EMpro acts as Modbus/TCP server and opens port 502 for communication with any Modbus/TCP clients. This port cannot be configured by the user.

Since TCP is a connection-oriented protocol, a client first has to establish a TCP connection with the EMpro to exchange data via Modbus/TCP.

The number of Modbus/TCP connections that can be open in parallel on each version of the EMpro product family is limited to four.

If there are already four open Modbus/TCP connections on the EMpro, additional connection queries on port 502 are rejected.

Additionally, to enable Modbus/TCP communication, the user has to make sure that this port is enabled in the network.

The MBAP contains a field that is declared as *unit identifier* in the specification. This *unit identifier* is comparable with the device address of Modbus/RTU. However, it is not relevant for the EMpro in the case of Modbus/TCP and is ignored by the device since through its IP address the device already has a unique address in a network. An exception applies if the device is operated in gateway mode (see [Section "Modbus gateway" on page 140](#)).

The Modbus TCP specification recommends using 255 as *unit identifier* for queries.

All EMpro versions support the Modbus TCP protocol.

11.2.4 Modbus gateway

EMpro versions with an RS-485 interface can optionally be operated in gateway mode.

By default upon delivery, the gateway mode is not active. In this case, the device acts as Modbus TCP server on the Ethernet interface and as Modbus/RTU slave on the RS-485 interface.

When the gateway function is activated, the device behaves as Modbus gateway on the Ethernet interface and, in parallel, continues to operate as Modbus TCP server (can be reached via *unit identifier* == 255).

On the RS-485 interface, the device now acts as Modbus/RTU master. As master, the EMpro can now independently send queries in the network (note: there must be no other master in the system).

As Modbus gateway, the device converts an incoming Modbus TCP message (that does not have the *unit identifier* 255 in the MBAP header) into a Modbus RTU message and forwards it to the appropriate receiver in the Modbus RTU network. On the TCP side, the *unit identifier* is used for addressing the Modbus RTU receiver. In turn, the response is converted from Modbus/RTU format back to Modbus/TCP format and is sent to the querying client as Modbus/TCP response.

Broadcast messages in gateway mode

The Modbus specification does not describe the behavior of a gateway device when the *unit identifier* in the MBAP header has a value of 0. In the Modbus/RTU network, this value represents a broadcast message.

There are different interpretations of the behavior of a gateway in this case.

The following questions regarding the behavior of a gateway remain open:

- Forwarding the broadcast in the RTU network.
Since there is no broadcast in the case of Modbus/TCP, it is not defined whether or not the MBAP address 0 is forwarded in the RTU network by the Modbus gateway.
- Response messages with the *unit identifier* 0.
Neither is there a definition on whether the gateway itself generates an answer to messages with a unit identifier of 0.

By default upon delivery, devices of the EMpro product family behave as follows:

The EMpro does not forward messages with *unit identifier* 0 to the RTU network as broadcast. Furthermore, the EMpro itself responds to the query as Modbus TCP server.

Timing in gateway mode

As gateway, the EMpro acts as Modbus master on the Modbus/RTU side and forwards queries to the addressed slaves.

As Modbus/RTU master, the device requires a time-out for queries. If this time-out has expired without a response from the Modbus/RTU slave, the gateway replies to the Modbus/TCP client with an error message.

By default upon delivery, the duration for the time-out is 250 ms.

Unsuitable time-out settings both at the gateway and at the querying Modbus/TCP client can cause unwanted problems.

Problems can occur if the time-out times at the Modbus/TCP client or EMpro in gateway mode are too short, or if the ratios between these two time-out times are unfavorable.

The time-out setting has to be individually configured based on the application.

Nevertheless, the following recommendations can be given; they should work in normal cases.

- The default setting of the EMpro is adequate for most applications.
- If there are slaves with slow response times in the RTU network, the time-out setting of the gateway should be increased.
- If very slow Baud rates are used on the RS-485, the time-out setting of the gateway should be increased.
- The time-out duration of the querying Modbus/TCP client should always be longer than that of the gateway.

11.3 PROFINET

11.3.1 Software

1. Check whether the firmware of your energy measuring device is up to date with the firmware available on the Phoenix Contact homepage. If the firmware is not up to date, download the current firmware from the specific product site at phoenixcontact.com (see Section “Firmware update” on page 129).
2. Download the current GSDML file for your energy measuring device from the Phoenix Contact website.

Additional requirements:

- Pertinent knowledge of the preferred PROFINET engineering system
- Executable project with configured controller

11.3.2 Preparing the GSDML file

1. Unpack the ZIP file on your file system.

11.3.3 Integrating the GSDML file

Integrate the GSDML file into your existing engineering system.

An example of the integration is shown below, using the TIA portal V15.

1. Select “Options, Manage general station description files (GSD)”.

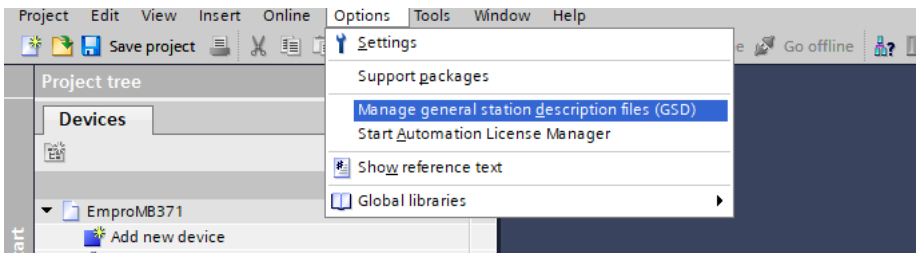

Figure 11-5 “Options, Manage general station description files (GSD)”

11.3.4 Integrating hardware

1. Create a project with any PROFINET-capable controller.

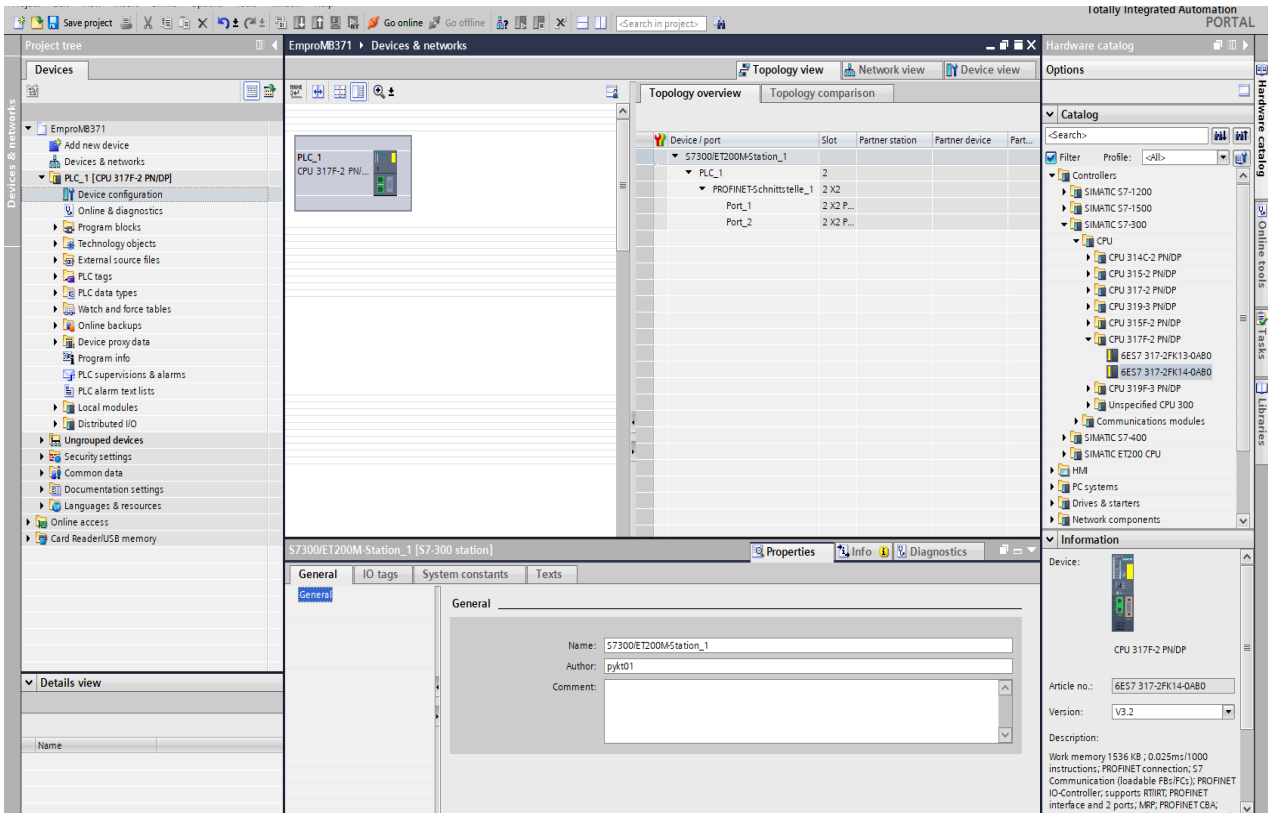

Figure 11-8 “Devices & networks” in the network view

EMpro - multi-functional energy measuring devices for front panel installation

2. Select “Devices & networks, Network view, Hardware catalog, Other field devices, PROFINET IO , Sensors, Phoenix Contact, EMpro” and select your installed EMpro (e.g., EMM-MB371-PN).

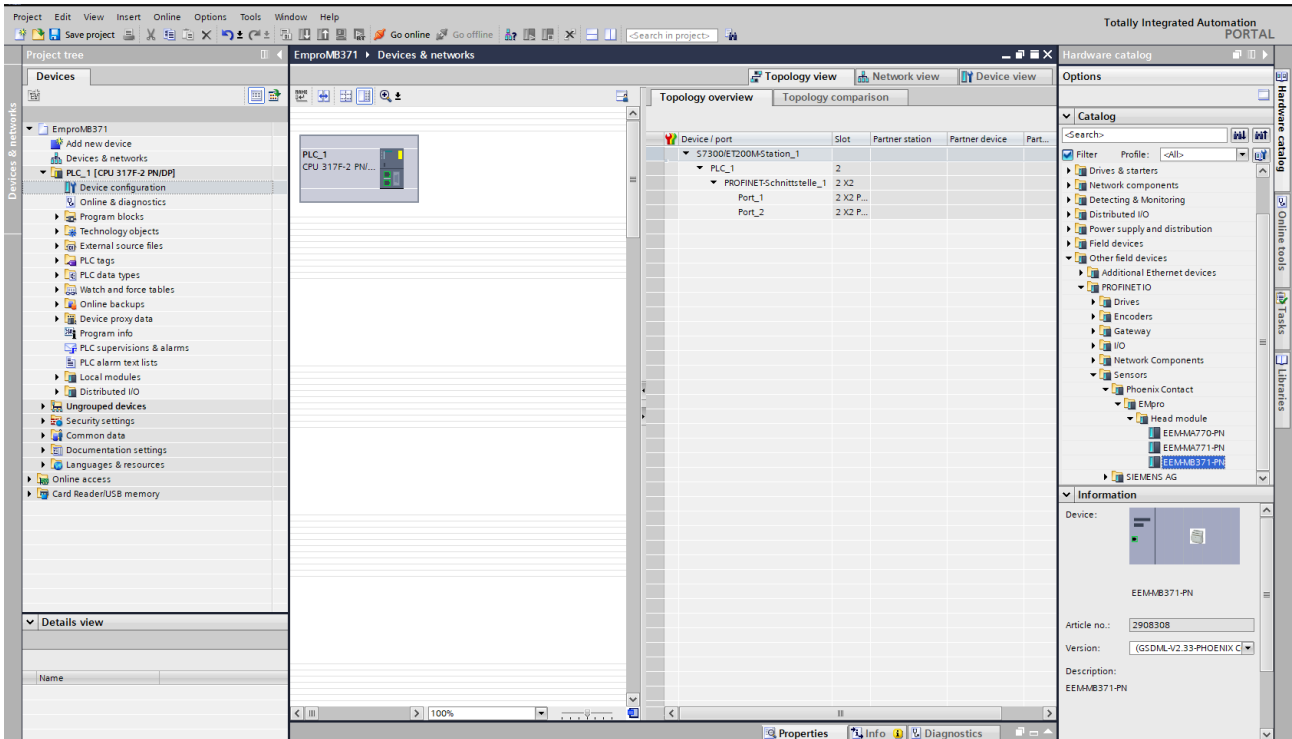

Figure 11-9 Selecting the EMpro from the hardware catalog

3. Drag and drop the EMpro from the hardware catalog to the network view.

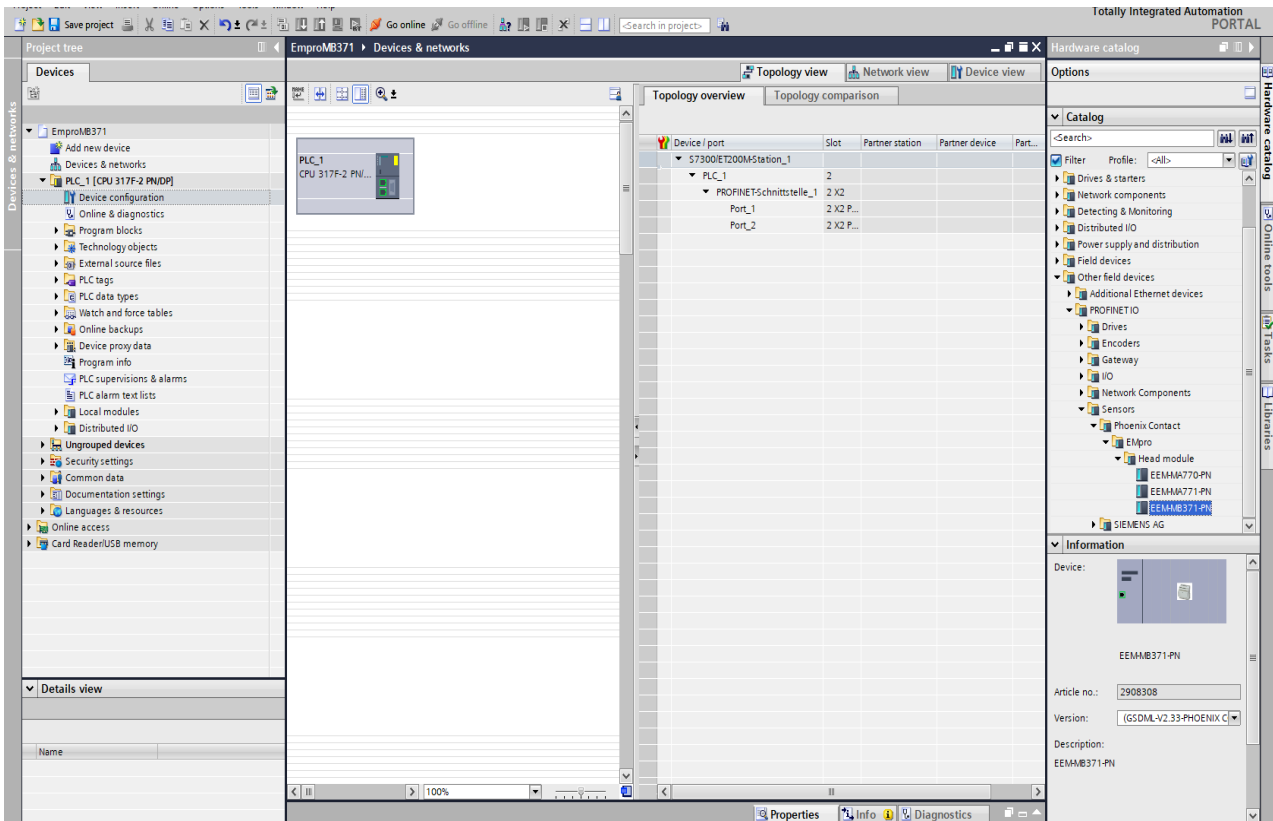

Figure 11-10 Adding the EMpro to network view

EMpro - multi-functional energy measuring devices for front panel installation

The EMpro appears in the network view.

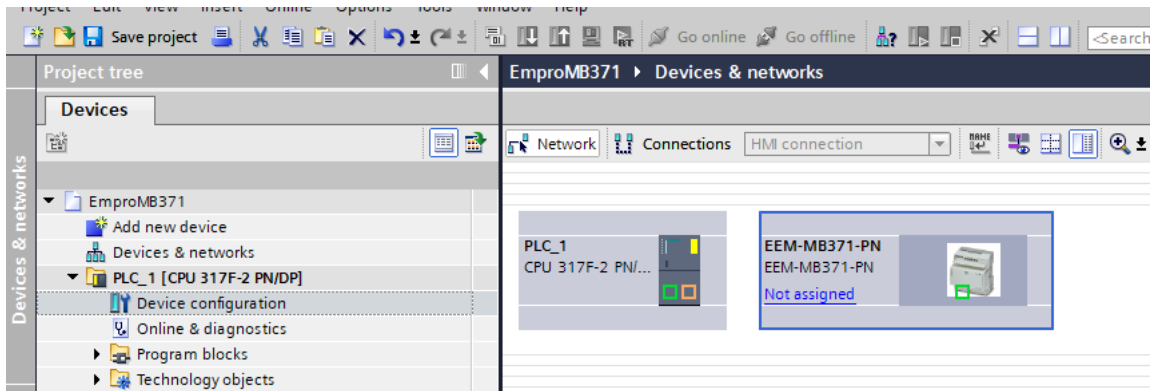

Figure 11-11 EMpro in the network view

4. Right-click on the EMpro in the network view.
5. Select “Assign to a new IO controller”.

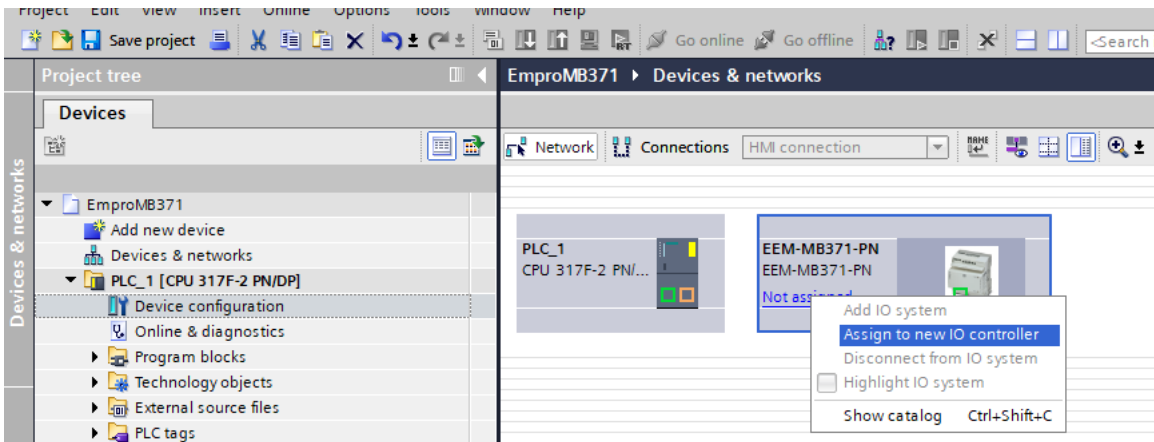

Figure 11-12 Assigning an I/O controller to the EMpro

6. Select the desired network interface.
7. Confirm with “OK”.

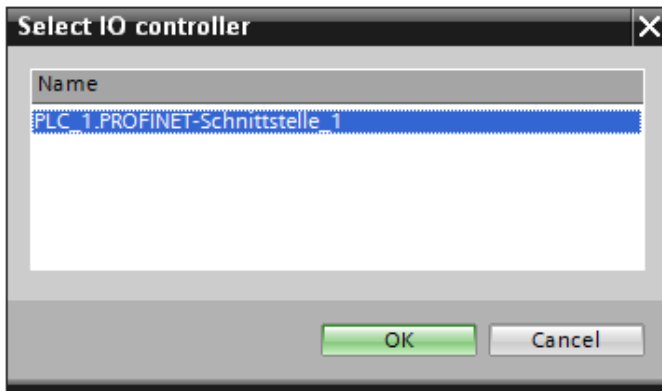

Figure 11-13 Selecting the I/O controller

The assignment has now been set up.

EMpro - multi-functional energy measuring devices for front panel installation

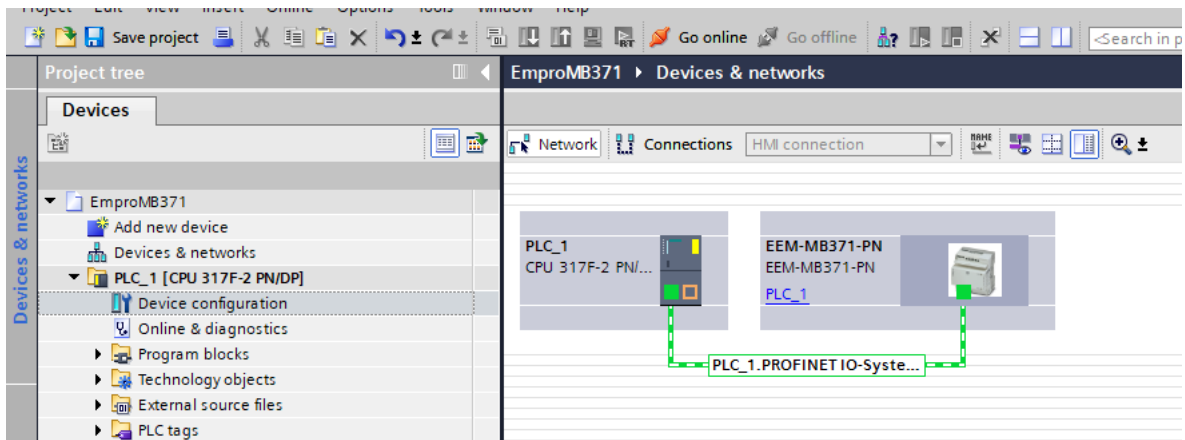

Figure 11-14 Networking controller and energy measuring device

11.3.5 Integrating modules and submodules

1. In the structure tree, switch to the “Device configuration” view.
2. In the hardware catalog, mark the desired module.
3. Drag and drop it to the device overview.

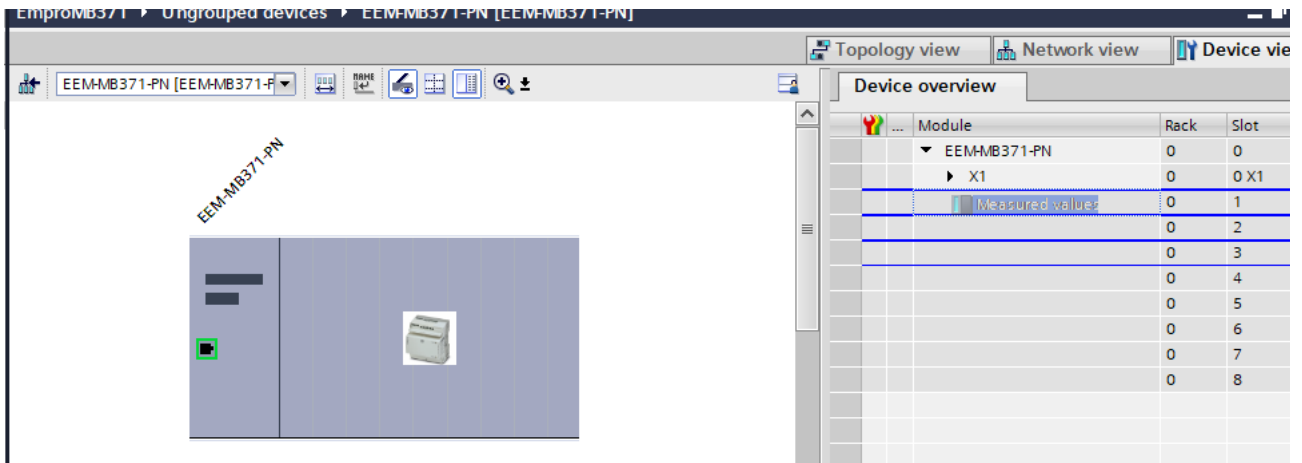

Figure 11-15 Adding a module to the device overview

EMpro - multi-functional energy measuring devices for front panel installation

Subsequently, the associated submodules appear in the catalog.

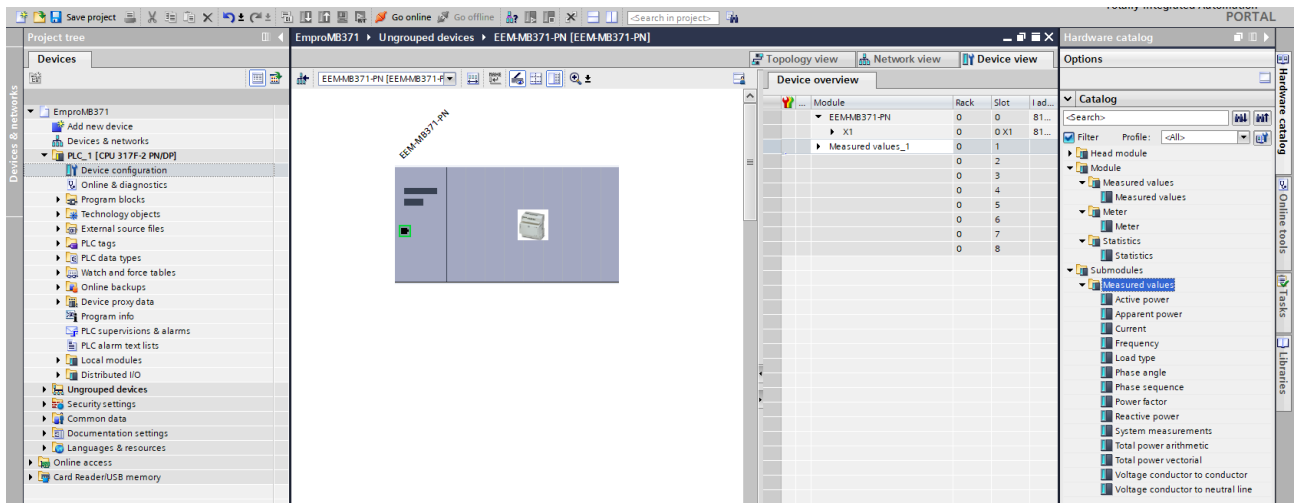

Figure 11-16 Submodules in the hardware catalog

4. Select the desired submodules.
5. Add the submodules under the respective main module using drag-and-drop.

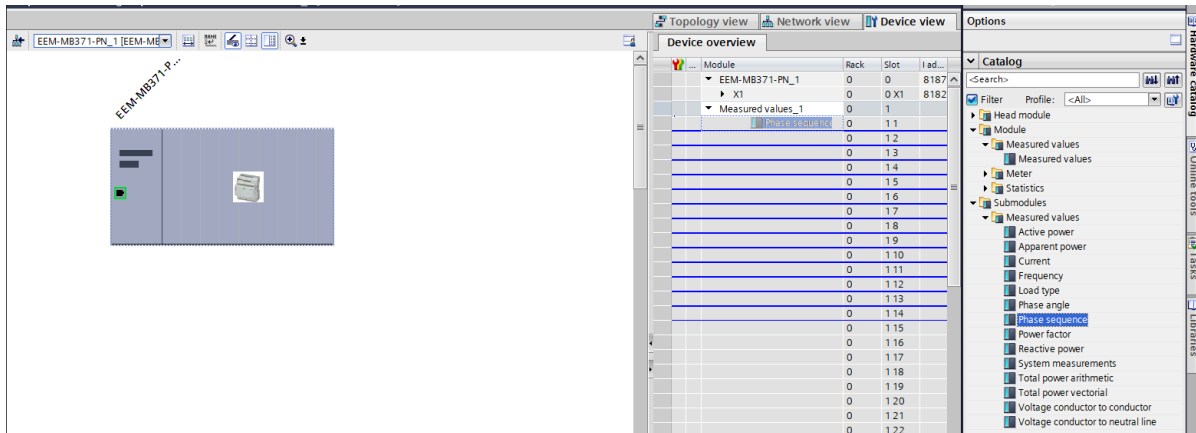

Figure 11-17 Inserting submodules

EMpro - multi-functional energy measuring devices for front panel installation

The device overview shows the available modules and submodules.

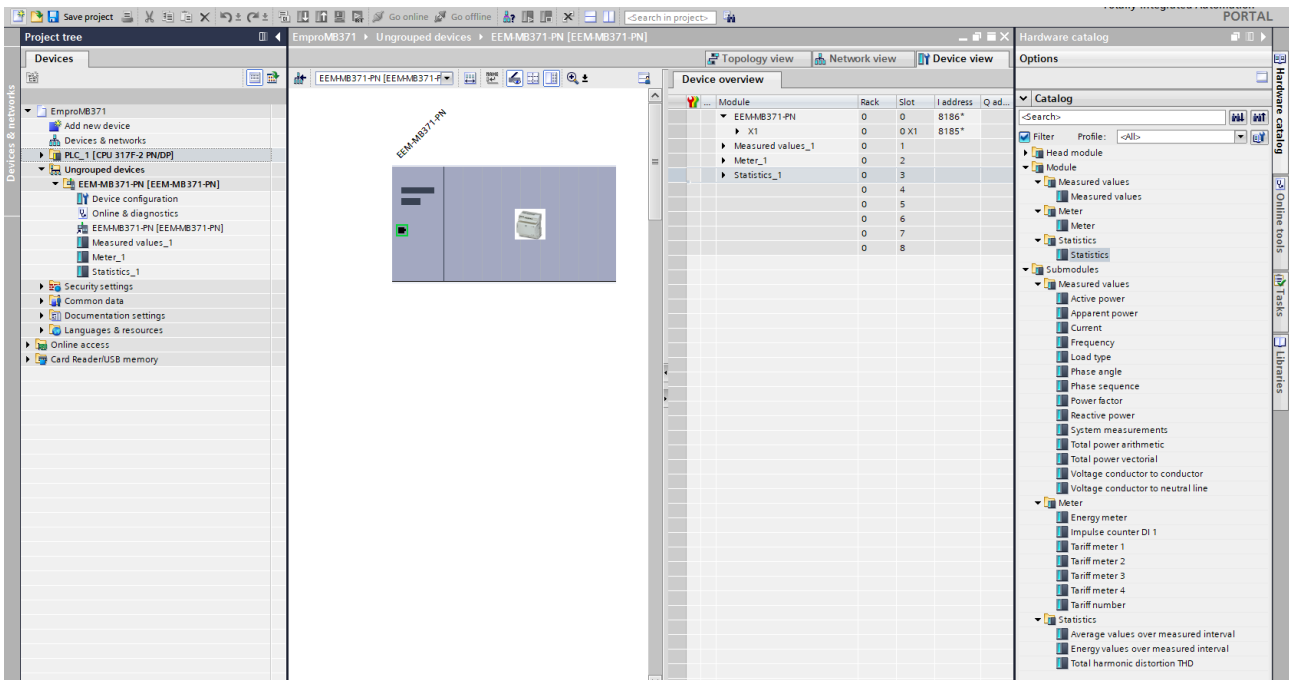

Figure 11-18 Available modules and submodules

6. Select a configured submodule in the device overview.

If you are a Siemens user, refer to the register table for the respective energy measuring device for descriptions of the individual process data, which can be downloaded at phoenixcontact.net/products.

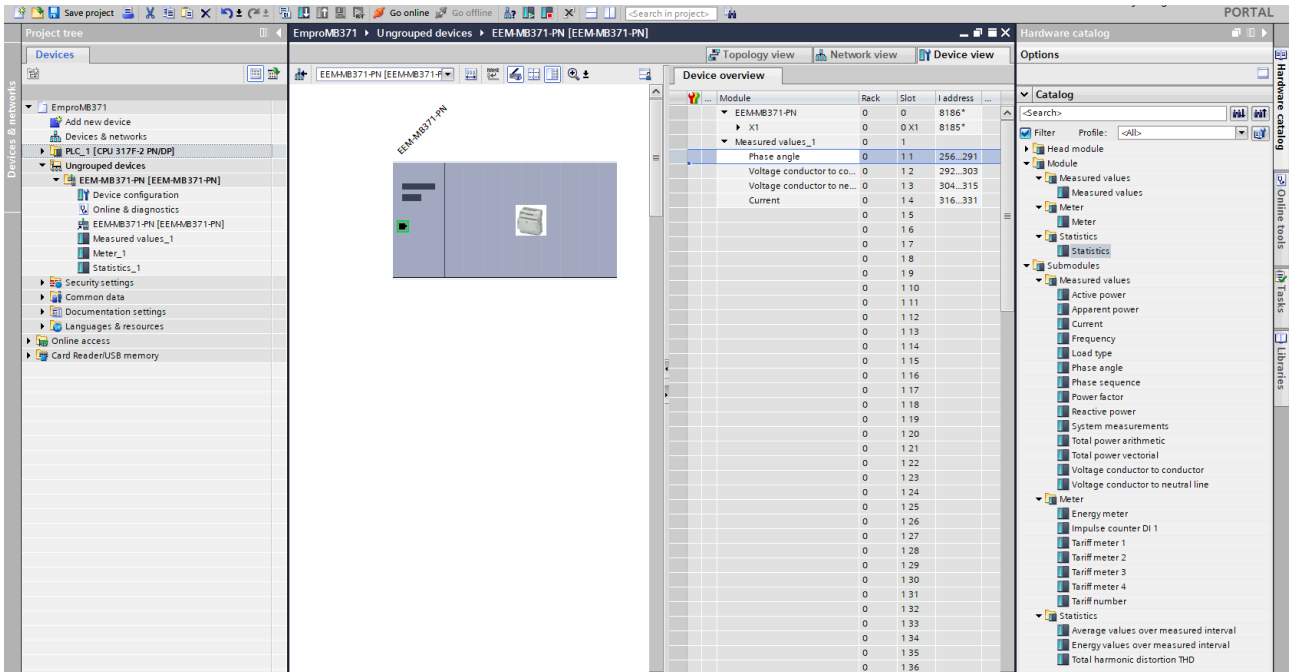

Figure 11-19 Selecting a submodule in the device overview

11.3.6 Linking process data

1. Create PLC variables with unique designations.
2. Connect these with the I/O variables.

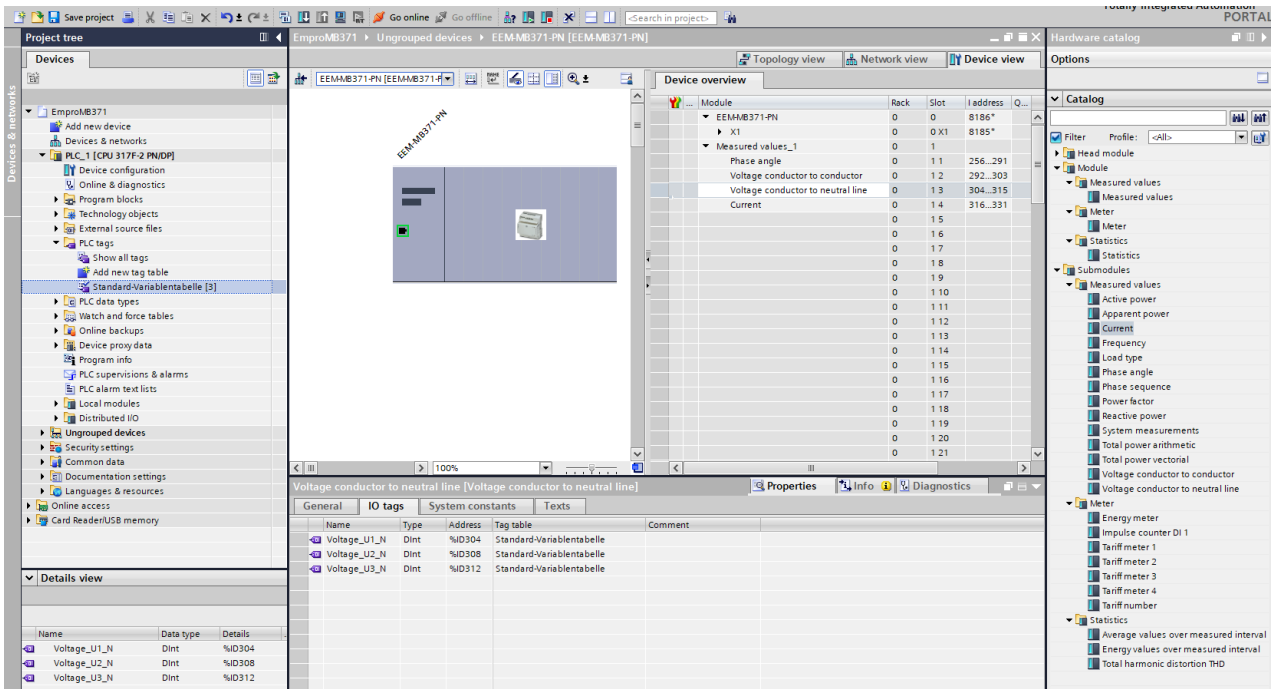

Figure 11-20 Creating PLC variables and connecting them with I/O variables

11.3.7 Assigning a device name

1. Right-click on the device to which you want to assign a name.
2. Select “Assign device name”.

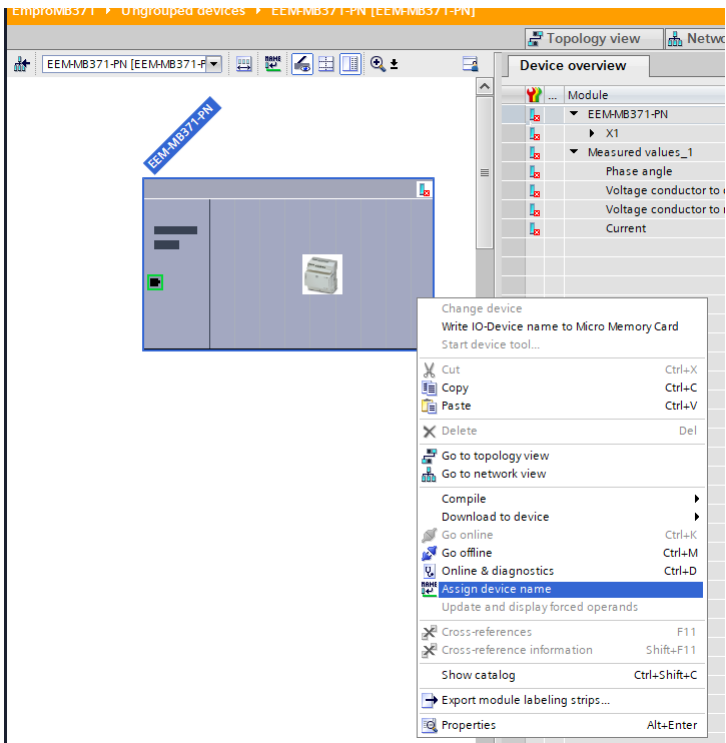

Figure 11-21 “Assign device name”

3. Click "Update list".

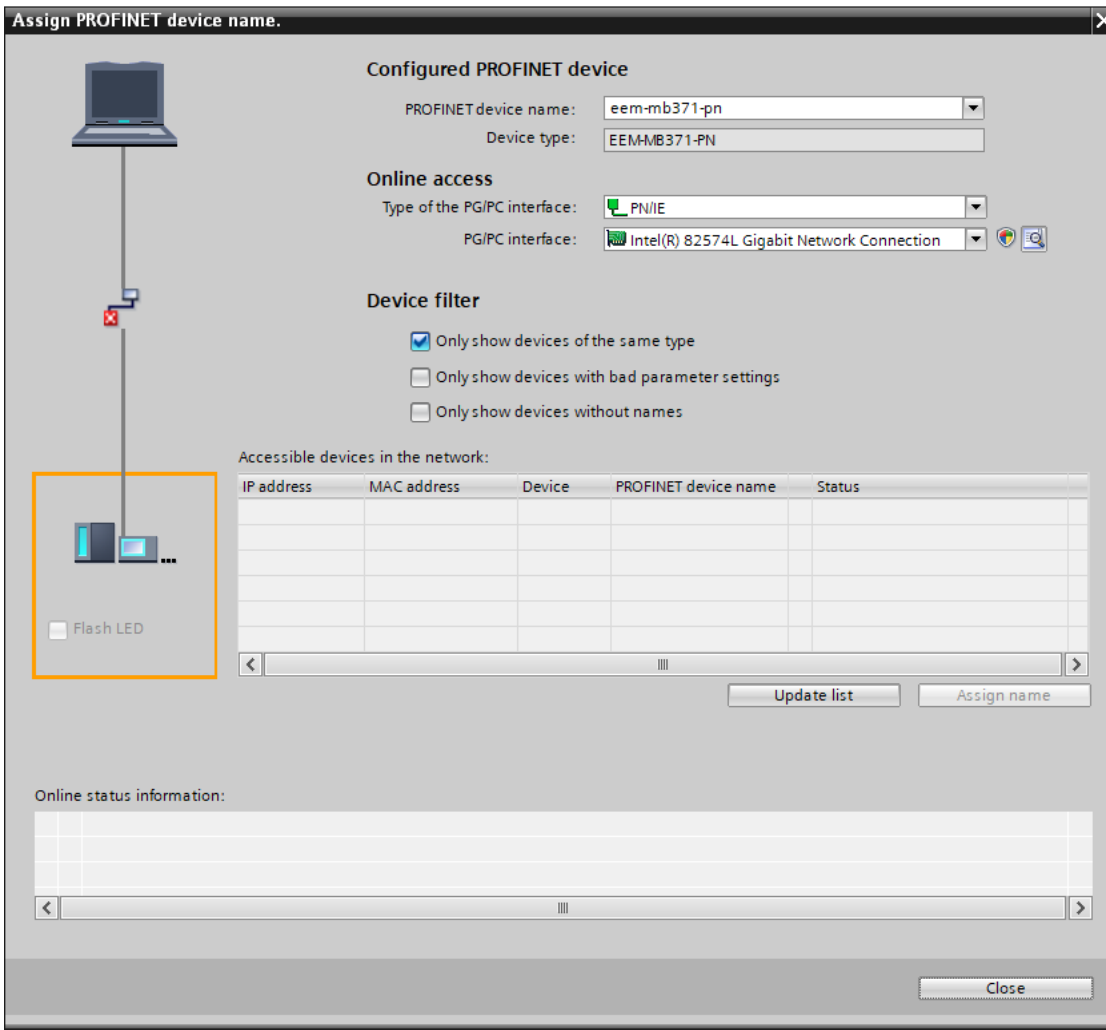

Figure 11-22 "Update list"

4. Select the device from the table.
5. Click “Assign name”.

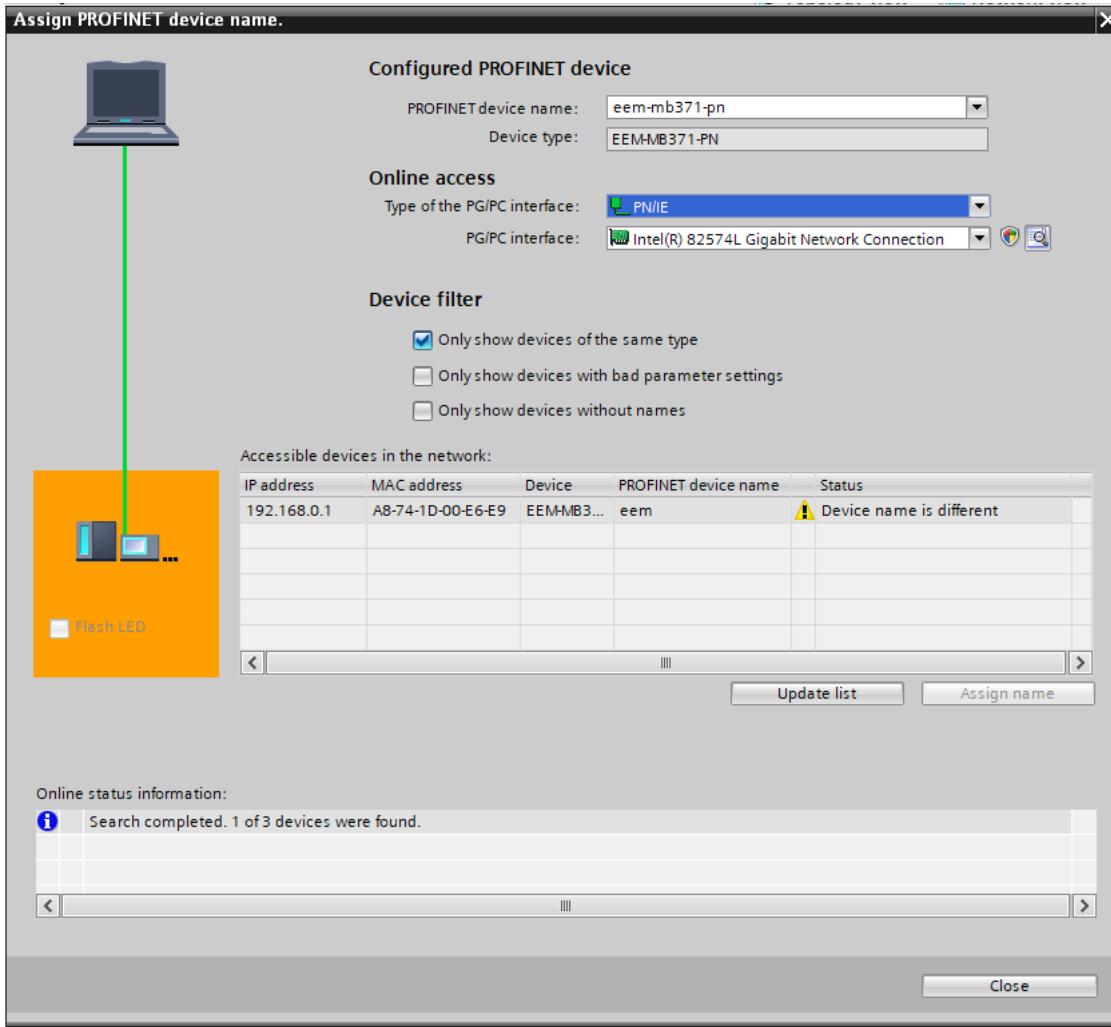

Figure 11-23 “Assign name”

EMpro - multi-functional energy measuring devices for front panel installation

The device name has been assigned successfully.

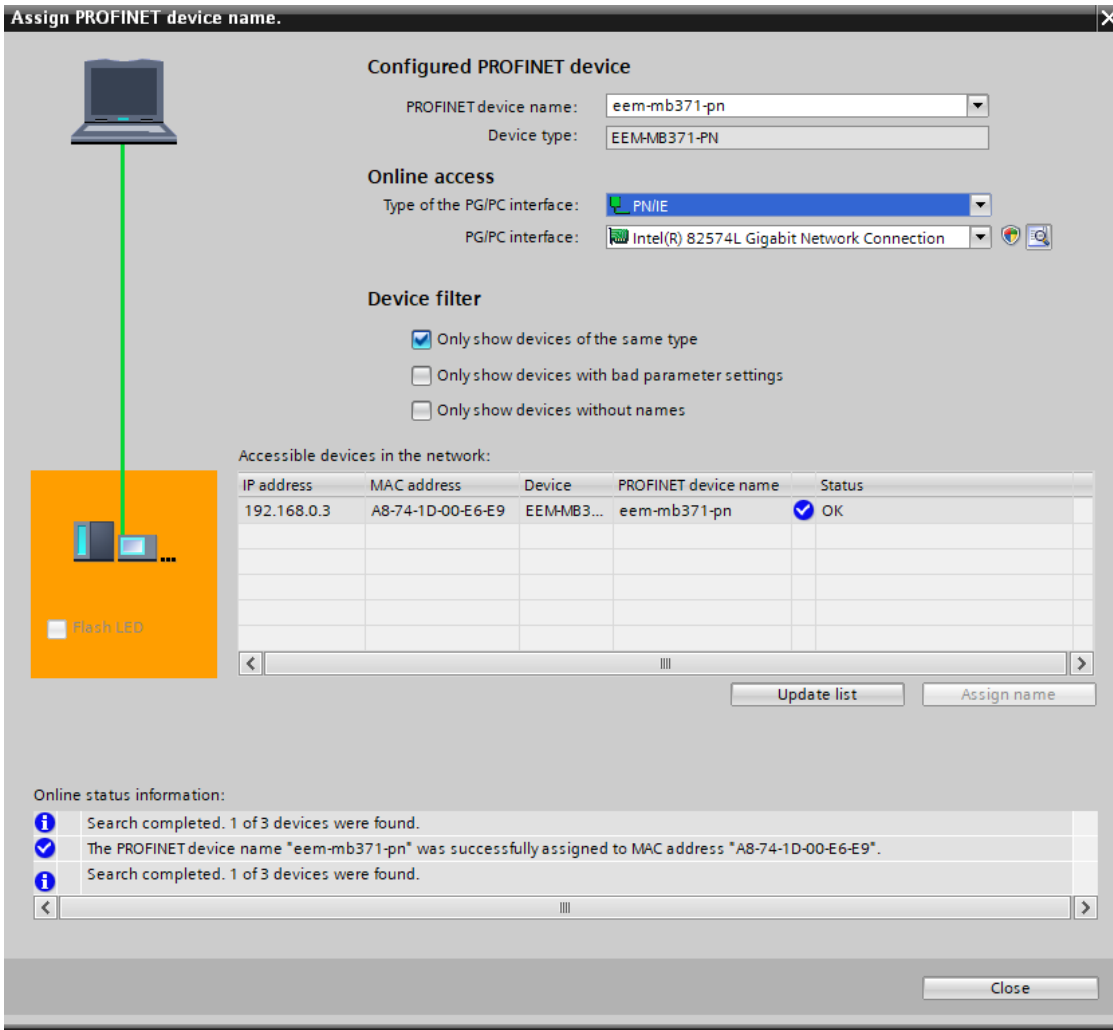

Figure 11-24 Assigning a PROFINET device name

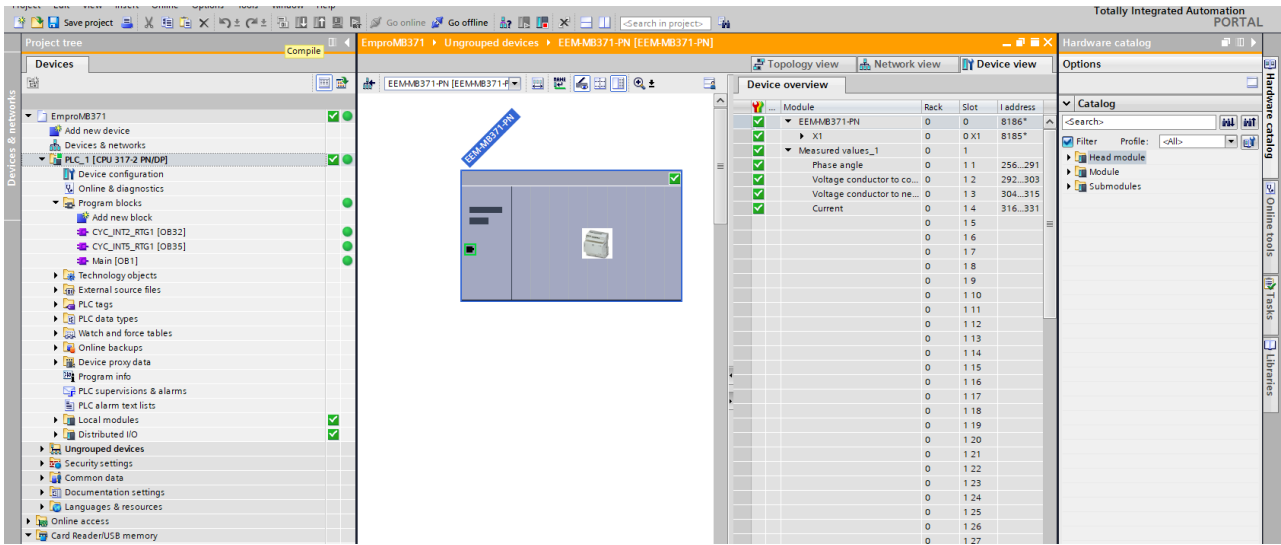
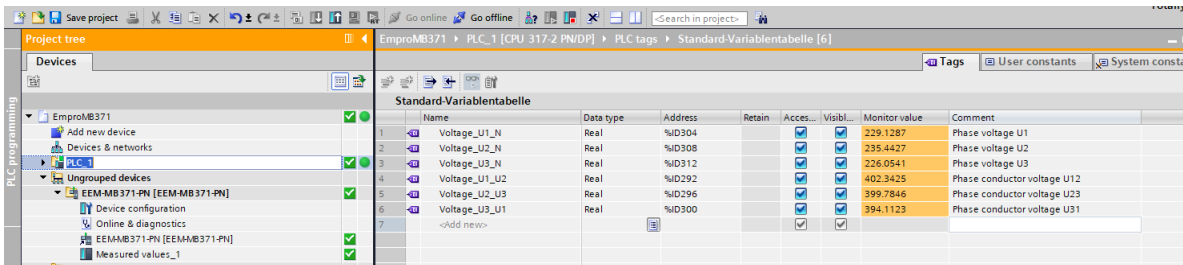

Figure 11-25 Assigning a PROFINET device name

11.3.8 Function check

You can perform a function check by creating a monitoring table for viewing the online values.

1. Compile the project.
2. Load it onto your controller.
3. Connect to the controller.
4. To perform a function check, switch to online mode and activate the monitoring by clicking on the glasses icon.



	Name	Data type	Address	Retain	Access	Visible	Monitor value	Comment
1	Voltage_U1_N	Real	%D304		<input checked="" type="checkbox"/>	<input checked="" type="checkbox"/>	229.1287	Phase voltage U1
2	Voltage_U2_N	Real	%D308		<input checked="" type="checkbox"/>	<input checked="" type="checkbox"/>	235.4427	Phase voltage U2
3	Voltage_U3_N	Real	%D312		<input checked="" type="checkbox"/>	<input checked="" type="checkbox"/>	226.0541	Phase voltage U3
4	Voltage_U1_U2	Real	%D292		<input checked="" type="checkbox"/>	<input checked="" type="checkbox"/>	402.3425	Phase conductor voltage U12
5	Voltage_U2_U3	Real	%D296		<input checked="" type="checkbox"/>	<input checked="" type="checkbox"/>	399.7846	Phase conductor voltage U23
6	Voltage_U3_U1	Real	%D300		<input checked="" type="checkbox"/>	<input checked="" type="checkbox"/>	394.1123	Phase conductor voltage U31
7	<Add new>				<input checked="" type="checkbox"/>	<input checked="" type="checkbox"/>		

Figure 11-26 Monitoring table

11.4 Configuration

11.4.1 Modbus/RTU

Table 11-3

Function	Information	Web server	Display	Register
Activation of Modbus/RTU	The Modbus/RTU protocol is activated by default, but can be deactivated by the user.	x	x	x
Modbus address	The default setting is address 1.	x	x	x
Baud rate	The default setting for the RS-485 interface is 19200 bps.	x	x	x
Stop bits	The default setting for the RS-485 interface is 1 stop bit.	x	x	x
Parity	The default setting for the RS-485 interface is even parity.	x	x	x

11.4.2 Modbus/TCP

Table 11-4 Modbus/TCP

Function	Information	Web server	Display	Register
Activation of Modbus/TCP	The Modbus/TCP protocol is activated by default, but can be deactivated by the user.	x	x	x

11.4.3 Modbus gateway

Table 11-5 Modbus gateway

Function	Information	Web server	Display	Register
Activation of the gateway mode	By default, the gateway mode is deactivated.	x	x	x
Modbus gateway time-out	The default setting is 250 ms.			

11.5 Security

On most registers, write commands are PIN-protected. To change register values, the correct PIN is required. The PIN corresponds to the display PIN.

The PIN can be changed by the user.

To prevent unauthorized write access to the device, change the default PIN during initial commissioning of the device.

Table 11-6 PIN

Function	Information	Web server	Display	Register
PIN change	The default PIN is 0100.		x	x

11.6 Data types and registers

The Modbus specifications does not include requirements on how various data types are to be displayed on the respective register.

The specification only defines that the register has to be represented as “big endian”. This means that the high byte of a register is sent first, followed by the low byte.

8-bit integer types:

Example: Value = 1 (0x01)

Table 11-7 8-bit integer types

Register address	Register contents (hex)
n	0x0001

16-bit integer types:

Example: Value = 4660 (0x1234)

Table 11-8 16-bit integer types

Register address	Register contents (hex)
n	0x1234

32-bit integer types:

Example: Value = 305419896 (0x12345678)

Table 11-9 32-bit integer types

Register address	Register contents (hex)
n	0x5678
n + 1	0x1234

32-bit IEE 754 floating point:

Example: Value = 123.456 (0x42F6E979)

Table 11-10 32-bit IEE 754 floating point

Register address	Register contents (hex)
n	0xE979
n + 1	0x42F6

ASCII strings:

Example: Value = EEM-MA (0x45, 0x45, 0x4D, 0x2D, 0x4D, 0x41, 0x33, 0x37, 0x30 -> ASCII coded)

Table 11-11 ASCII strings

Register address	Register contents (hex)
n	0x4545
n +1	0x2D4D
n +2	0x414D
n +3	0x3733
n +4	0x0030

11.7 Register table

The register table is available for download from the Phoenix Contact website.

1. Open phoenixcontact.net/products.
2. Enter the order number of your energy measuring device into the search field.
3. In the download area of the product, you will find the register table under “Miscellaneous”.

11.8 Contents of the register table

The register table contains information that concerns the contents and functions of the communication interfaces.

The register table encompasses the entire Modbus register.

To get the PROFINET-specific register, filter the empty cells from the “GSDML Module Name” column, so that only cells that are filled with content remain.

11.9 Description of the register table

CH	Dec	Hex	Count	Unit	Divider	R/W	Datatype	Name (EN)	Description (EN)
H1	0	0						Device data	
H2	256	100						Device information	
R	256	100	2	-	-	R	UInt32	Firmware revision	Firmware revision as unsigned integer
R	300	012C	8	-	-	R	ASCII	Device identifier	Device identifier as NULL terminated ASCII character string
R	308	134	8	-	-	R	ASCII	Item number	Article number as NULL terminated ASCII character string
R	316	013C	9	-	-	R	ASCII	Serial number	Serial number as NULL terminated ASCII character string
R	325	145	8	-	-	R	UInt8[]	UUID	Universally Unique Identifier (UUID) consisting of 128 Bit
R	336	150	1	-	-	R	UInt16	Day of production	Production day of the device (UTC)
R	337	151	1	-	-	R	UInt16	Month of production	Production month of the device (UTC)
R	338	152	1	-	-	R	UInt16	Year of production	Production year of the device (UTC)
R	339	153	1	-	-	R	UInt16	Hour of production	Production hour of the device (UTC)
R	340	154	1	-	-	R	UInt16	Minute of production	Production minute of the device (UTC)
R	341	155	1	-	-	R	UInt16	Second of production	Production second of the device (UTC)
R	342	156	2	-	-	R	UInt32	Serial number	Serial number as unsigned integer
R	346	015A	1	-	-	R	UInt16	Hardware revision	Hardware revision, splitted in major- and minor version.
R	416	01A0	16	-	-	R	ASCII	Bootloader revision	Bootloader revision as NULL terminated ASCII character string
H2	1024	400						Device configuration	

Figure 11-27 Register table

Content of the line (CH)

The first line of the register table contains information about the content of the respective line or column.

H1 ... Hn: Heading

An “H” with a number indicates a heading. The number behind it indicates the hierarchical level.

To keep the register entries structured and readable, they are divided by headings.

R: Register

The “R” stands for Register and designates the lines that each describe a register.

Only lines that also contain registers are relevant for automatic processing of the register table.

U: Unused

The “U” describes unused entries. These can be, e.g., address ranges that do not have a function (yet) and are reserved.

E: End

The “E” describes the end of the table.

Dec: Decimal address

The second column of the register table contains register addresses in decimal form.

Hex: Hexadecimal address

The third column of the register table contains register addresses in hexadecimal form.

Count

The “Count” column displays the number of registers required for the function described in this line. The required number is directly dependent on the data type.

Short designation

The “Short designation” column contains the abbreviated designations of the registers. The short designations are unique, so that all other data can be referenced using the short designations.

Unit

The unit for the process values is given in the “Unit” column. For example, the unit for the voltages is volt [V].

Divider

The “Divider” column states the divider by which the value is to be divided to get the correct value. This is necessary, e.g., if the data type is an integer value, but a decimal fraction has to be entered.

Example:

If the harmonics are specified as percentage with signed integer, but have to be output with a precision of a tenth of a percent. In this case, for example, 15.2% is used as 152 with divider 10.

R/W: Read/write access

This column specifies which access is permitted for the respective register.

R: Read only

These registers can only be read. Attempting write access to these registers causes an error.

R/W: Read and write

It is possible to both read and write to these registers.

W: Write only

These registers can only be written. Attempting read access to these registers causes an error.

W/R0: Write only and read 0

These registers can only be written. Read access to these registers results in a zero as response.

Datatype

This column contains the data type to be used for decoding the contents of each respective register.

ASCII

Each register (16 Bit) contains two ASCII characters. When the number is entered, the number of individual registers contained in the character string is determined.

Example:

Dez:1234567

Hex: 0X31, 0X32, 0X33, 0X34, 0X35, 0X36, 0X37

Zero-terminated: "12345670"

Hex: 0X31, 0X32, 0X33, 0X34, 0X35, 0X36, 0X37, 0X00

Number of registers = 4: Hex: 0X3231, 0X3433, 0X3534, 0X0037

Bit mask

Each bit (bit 15-bit 0) of the register (16 bit) is evaluated individually.

Example: "Resetting the tariff meter"

Bit 0: Reset tariff 1

Bit 1: Reset tariff 2

Bit 2: Reset tariff 3

Bit 3: Reset tariff 4

An individual tariff meter, or any combination of meters from all tariff meters can be reset.

Bool

This data type makes a logical statement.

0: false

1: true

FI32

IEEE-754-single number 1.8.23 (32 bits, two 16-bit registers):

1 sign bit: positive and negative

8 exponent bits: ≈ value range of 38 decimal places

23 mantissa bits ≈ precision of 6 decimal places

Decimal value range: $\pm 1.175 \cdot 10^{-38}$ to $3.40282 \cdot 10^{+38}$

Register in float

32-bit value from the registers: 0X41340000 = 01000001 00110100 00000000 00000000b

Bit31 = 0: SB, sign bit. This number is positive.

Bit30 - Bit23: E, exponent. In this case: 130.

Bit22 - Bit0: M, mantissa. Here it is 3,407,872.

Z = 11.25

Float in register

Floating-point number X = 11.25

SB, sign bit. This number is positive => Bit31 = 0 / 0X00 / 0b

In this case 130 => Bit30 - Bit23 = 130 / 0X82 / 10000010b

mantissa. Here it is 3,407,872 => Bit22 - Bit0 = 3407872 / 0x340000 / 0110100 00000000 00000000b

32-bit value for the register: 0X41340000 = 01000001 00110100 00000000 00000000b

SInt16

Signed integer:

2 byte, 16 bit

Value range: $-2^{15} \dots 2^{15}-1$

-32,768 ... 32,767

UInt16

Unsigned integer:

2 byte, 16 bit

Value range: $0 \dots 2^{16}-1$

0 ... 65,535

UInt32

Unsigned integer:

4 byte, 32 bit

Value range: $0 \dots 2^{32}-1$

0 ... 4294967295

SInt32

Signed integer:

4 byte, 32 bit

Value range: $-2^{31} \dots 2^{31}-1$

-2,147,483,648 ... 2,147,483,647

UInt8

Only the low byte of the register is evaluated.

1 byte, 8 bit

Value range: $0 \dots 2^8 - 1 = 0 \dots 255$

UInt[]

Array of UInt8 values. Their order follows that of the ASCII registers.

These data types are used, e.g., for the MAC addresses.

Three registers are required for the six bytes.

E.g., 00:A00:45:66:4F:41

Name

Here, the name of the respective register is entered. It may be longer than the short designation, so that it is readable and expresses the function of the register.

Description

In this column, the function of the register is described in detail.

12 Technical data

Technical data	
General data	
Measuring principle	True r.m.s. value measurement (TRMS) up to 63rd harmonic
Measurement value	AC sine
Nominal frequency	50/60 Hz
Frequency range	45 ... 65 Hz
Sampling rate	256 times the signal frequency: 12800 Hz @ FSignal = 50 Hz 15360 Hz @ FSignal = 60 Hz
Degree of protection	IP 54 (display with seal) IP20 (housing)
Dimensions	
Width/height/depth	
EEM-MA77x	96 mm x 96 mm x 73.25 mm
EEM-MA77x(-R)	96 mm x 96 mm x 73.25 mm
EEM-MA77x(-PN, -EIP):	
Without PN-/EIP socket	96 mm x 96 mm x 81.25 mm
With PN-/EIP socket	96 mm x 96 mm x 89.8 mm
Installation depth	
EEM-MA77x:	58.25 mm
EEM-MA77x(-R):	61.6 mm
EEM-MA77x(-PN, -EIP):	66.25 mm - to the housing edge 74.8 mm - to the plug edge (PN/EIP)
Plugs that are plugged in from behind are not considered in these specifications	
Voltage measurement	
Input measuring range, direct	18 V AC ... 690 V AC (Ph/Ph) 11 V AC ... 400 V AC (Ph/N)
Input measuring range using transformer	
Primary	60 V AC ... 2,000,000 V AC
Secondary	60 V AC ... 400 V AC
Power consumption	<0.5 VA
Overvoltage (permanent)	760 V AC Ph/Ph 440 V AC Ph/N
Accuracy	0.2%

EMpro - multi-functional energy measuring devices for front panel installation

Technical data [...]	
Current measurement, current transformer	
Input current:	
Primary nominal current	1 A AC ... 20,000 A AC
Secondary	1 A AC or 5 A AC
Overload capacity	6 A AC
Short-term overload	50 A for 1 s
Power consumption	<0.5 VA
Discrimination threshold	0.05% I _n
Accuracy	0.2% (10% ... 120% I _n)
Current measurement, Rogowski coil direct connection	
Input measuring range using transformer	
Primary	100 A AC ... 20,000 A AC
Secondary	40 mV AC or 400 mV AC
Secondary measuring range	0 mV AC ... 48 mV AC or 0 mV AC ... 480 mV AC
Overload capacity	1.2 x I _n = 1.2 x 400 mV AC = 480 mV AC
Short-term overload	
Discrimination threshold	0.1% I _n
Accuracy	0.5% (10% ... 120% I _n)
Power measurement	
Accuracy, active power:	
Current transformer:	0.5% (in acc. with DIN EN 61557-12)
Rogowski coil direct connection:	1% (in acc. with DIN EN 61557-12)
Precision, reactive power:	
Current transformer:	1% (in acc. with DIN EN 61557-12)
Rogowski coil direct connection:	2% (in acc. with DIN EN 61557-12)
Accuracy, apparent power:	
Current transformer:	0.5% (in acc. with DIN EN 61557-12)
Rogowski coil direct connection:	1% (in acc. with DIN EN 61557-12)
Active energy in accordance with 62053-22	
Current transformer:	Class 0.5 S
Active energy in accordance with 62053-21	
Rogowski coil direct connection:	Class 1
Reactive energy in accordance with EN 62053-23	
Current transformer:	Class 2
Rogowski coil direct connection:	Class 2
Pulse value, LED test output	
Current transformer:	0.1 Wh/Imp
Rogowski coil direct connection:	100 Wh/Imp

Technical data [...]	
Supply	
Supply voltage range	80 V AC ... 480 V AC 120 V AC ... 300 V DC
Nominal supply voltage	100 V AC ... 400 V AC +/-20% 150 V DC ... 250 V DC +/-20%
Frequency	AC sine (50/60 Hz)
Power consumption	<4 W
Digital input in accordance with 61131-2 (type 3)	
Nominal voltage	24 V DC
Nominal current	-
Input voltage range	0 V DC ... 30 V DC
Signal ON time	≥30 ms
Signal OFF time	≥30 ms
Digital output in accordance with 61131-2 (type 3)	
Nominal voltage	24 V DC
Rated output current I _e	0.1 A
Output voltage range	19.2 V DC ... 30 V DC
Output current range	0 mA ... 100 mA
Ethernet interface	
RJ45/LAN	100Base-TX
Display	
Type	LCD display, two-color, backlit
Refresh	1 s, adjustable
Electrical isolation	
Basic insulation: housing against all potentials	IEC 61010-1
Overvoltage category III at 300 V AC	
Overvoltage category II at 600 V AC	
Reinforced insulation: supply against all other potentials	IEC 61010-1
Overvoltage category III at 300 V AC	
Overvoltage category II at 600 V AC	
Reinforced insulation: voltage measurement input against all other potentials	IEC 61010-1
Measurement category III at 300 V AC	
Measurement category II at 600 V AC	
Test voltage	4 kV AC (50 Hz, 1 min.)
Functional insulation: current measurement input against all other potentials	
Functional insulation: digital I/Os	
Functional insulation: communication interface	
Pollution degree	2

EMpro - multi-functional energy measuring devices for front panel installation

Technical data [...]	
Ambient conditions	
Ambient temperature (operation)	-10°C ... +55°C
Ambient temperature (storage/transport)	-25°C ... +85°C
Permissible humidity (operation)	≤95% non-condensing
Altitude	≤2,000 m
Connection data	
Conductor cross section, current (rigid/flexible)	0.2 mm ² ... 4 mm ² / 0.2 mm ² ... 6 mm ²
Conductor cross section, voltage (rigid/flexible)	0.5 mm ² ... 2.5 mm ² / 0.5 mm ² ... 4 mm ²
Conductor cross section, supply (rigid/flexible)	0.14 mm ² ... 2.5 mm ²
Conductor cross section, digital I/O (rigid/flexible)	0.14 mm ² ... 1.5 mm ² / 0.14 mm ² ... 2.5 mm ²
Conductor cross section, communication (rigid/flexible)	0.14 mm ² ... 2.5 mm ²
Connection method	Screw connection
Tightening torque	0.5 Nm
Date and time	
Precision of clock time during normal operation	±50 ppm
Precision of clock time during power reserve	±150 ppm
Duration of power reserve	<24 h
Time constant T	<1 h
Fuses	
DI/DO	≤250 mA
Supply	≤16 A
Conformance/approvals	
CE-compliant	RoHS, EMC, LVD
RoHS	EN 50581
EMC	EN 61000-6-2, EN 61000-6-3
LVD	EN 61010-1
UL, cULus-listed	UL 61010-1

A Appendixes

A 1 List of figures

Section 3

Figure 3-1:	Mounting	17
Figure 3-2:	Mounting terminal covers	17
Figure 3-3:	Pin assignment example	19
Figure 3-4:	Pin assignment example	20
Figure 3-5:	Connection L/N	21
Figure 3-6:	Connection L/L	21
Figure 3-7:	One-phase network, two conductors, one current transformer	22
Figure 3-8:	Two-phase network, two conductors, one current transformer	22
Figure 3-9:	Three-phase network, three conductors, one current transformer	23
Figure 3-10:	Three-phase network, three conductors, two current transformers	23
Figure 3-11:	Three-phase network, three conductors, three current transformers	23
Figure 3-12:	Three-phase network, four conductors, one current transformer	23
Figure 3-13:	Three-phase network, four conductors, three current transformers	24
Figure 3-14:	Two-phase network, three conductors, two current transformers	24
Figure 3-15:	One-phase network, two conductors, one Rogowski coil	25
Figure 3-16:	Two-phase network, two conductors, one Rogowski coil	25
Figure 3-17:	Three-phase network, three conductors, one Rogowski coil	25
Figure 3-18:	Three-phase network, three conductors, three Rogowski coils	25
Figure 3-19:	Three-phase network, four conductors, one Rogowski coil	26
Figure 3-20:	Three-phase network, four conductors, three Rogowski coils	26
Figure 3-21:	Two-phase network, three conductors, two Rogowski coils	26

Section 5

Figure 5-1:	Starting the basic device configuration	31
Figure 5-2:	Language selection	31
Figure 5-3:	Network settings	32
Figure 5-4:	IPv4	32
Figure 5-5:	Selection of grid type with current transformers	33
Figure 5-6:	Selection of grid type with Rogowski coils	33
Figure 5-7:	Current input (energy measuring device with current transformer)	34
Figure 5-8:	Current input (energy measuring device with Rogowski coil)	35

Figure 5-9:	Voltage input	35
Figure 5-10:	Configuration conclusion	36
Figure 5-11:	Setting a personal pin	36
Figure 5-12:	Activating the PIN	37
Figure 5-13:	Network settings	38
Figure 5-14:	Grid type	39
Figure 5-15:	Current input, current transformer	40
Figure 5-16:	Current input (Rogowski coil)	41
Figure 5-17:	Voltage input	43
Figure 5-18:	Voltage input with voltage transducer	44
Figure 5-19:	Configuration overview	45

Section 6

Figure 6-1:	Menu structure on the display	47
Figure 6-2:	Menu structure on the web server	48

Section 7

Figure 7-1:	“Language” menu	51
Figure 7-2:	Language selection	51
Figure 7-3:	“Date / Time” menu	52
Figure 7-4:	Settings: “Date / Time”	52
Figure 7-5:	“Settings, Date / Time, Settings, Manually” mode	53
Figure 7-6:	Menu: “Settings, Date / Time, Settings, SNTP Server” mode	54
Figure 7-7:	Menu: “Settings, Date / Time, Settings, Summer time rule”	57
Figure 7-8:	Menu: “Display, Contrast”	58
Figure 7-9:	Settings: “Display, Contrast”	58
Figure 7-10:	Menu: “Display, Brightness”	59
Figure 7-11:	Settings: “Display, Brightness”	59
Figure 7-12:	Menu: “Display, Permanent light”	60
Figure 7-13:	Settings: “Display, Permanent light”	60
Figure 7-14:	Settings: “Illumination time”	61
Figure 7-15:	Menu: “Display, Standard display”	62
Figure 7-16:	Settings: “Display, Standard display”	62
Figure 7-17:	Menu: “Display, Alarm light”	63
Figure 7-18:	Settings: “Display, Alarm light”	63
Figure 7-19:	Menu: “Display, Refresh time”	64
Figure 7-20:	Settings: “Display, Refresh time”	64

Figure 7-21:	Web server: “Settings, Display”	65
Figure 7-22:	Menu “Device info”	66
Figure 7-23:	Display “Device info”	66
Figure 7-24:	Menu: “System, Factory reset”	67
Figure 7-25:	Menu: “System, Factory reset”	67

Section 8

Figure 8-1:	Menu: “System, PIN xxxx”	70
Figure 8-2:	Settings: “System, PIN xxxx”	70
Figure 8-3:	Menu: “System, User management, Change password”	71
Figure 8-4:	Menu: “Settings, Display”	72
Figure 8-5:	Menu: “System, PIN active/WBM active”	73
Figure 8-6:	Setting: “System, WBM active”	73
Figure 8-7:	Setting: “System, PIN active”	73
Figure 8-8:	Menu “System, Configuration data, Export configuration”	75
Figure 8-9:	Menu: “System, Configuration data, Import configuration”	76
Figure 8-10:	Menu: “System, Configuration data, Transfer configuration”	77

Section 9

Figure 9-1:	Menu: “Home, Meter readings”	79
Figure 9-2:	Menu: “E, Energy total”	80
Figure 9-3:	Menu: “E, Energy total”	80
Figure 9-4:	Menu: “E, Energy resettable”	81
Figure 9-5:	Menu: “E, Energy resettable”	81
Figure 9-6:	Menu: “Tar, Tariff meter 1...4”	82
Figure 9-7:	Menu: “Tar, Tariff meter 1”	82
Figure 9-8:	Menu: “Device info, Operating hours/Load operation”	83
Figure 9-9:	Menu: “Device info, Operating hours/Load operation”	83
Figure 9-10:	Menu: “Settings, Average values”	85
Figure 9-11:	Menu: “Average values, Settings”	86
Figure 9-12:	AVG over fixed interval (fixed block)	87
Figure 9-13:	Sliding average value (sliding block)	87
Figure 9-14:	Rolling average value (rolling block)	88
Figure 9-15:	Prediction calculation (equally weighted average)	89
Figure 9-16:	Prediction generation (weighted average)	89

Section 10

Figure 10-1:	Digital input	92
Figure 10-2:	Menu: "Settings, Impulse counter"	93
Figure 10-3:	Menu: "Settings, Tariffs, Digital input"	95
Figure 10-4:	Menu: "UL-L"	97
Figure 10-5:	Menu: "UL-L, UL-L instantaneous" (instantaneous values, instantaneous)	97
Figure 10-6:	Menu: "UL-L, UL-L min" (minimum values, min)	97
Figure 10-7:	Menu: "UL-L, UL-L max" (maximum values, Max)	98
Figure 10-8:	Menu: "UL-L, UL-L AVG min" (minimum average values, AVG Min) ...	98
Figure 10-9:	Menu: "UL-L, UL-L AVG" (average values, AVG)	98
Figure 10-10:	Menu: "UL-L, UL-L AVG max" (maximum average values, AVG max)	98
Figure 10-11:	Menu: "Settings, Average values, Status"	99
Figure 10-12:	Menu: "Settings, Digital output"	100
Figure 10-13:	Menu: "Settings, Digital output", "Impulse" function	102
Figure 10-14:	Menu: "Settings, Digital output", "Device status" function	104
Figure 10-15:	Menu: "Settings, Digital output", "Manually" function	106
Figure 10-16:	Menu: "Settings, Digital output", "Alarm" function	108
Figure 10-17:	Menu: "Settings, Alarm, Status"	109
Figure 10-18:	Menu: "Settings, Alarm"	110
Figure 10-19:	Menu: "Digital output, Settings, "Rotary field direction"	112
Figure 10-20:	Menu: "Digital output, Settings", "Deactivated" function	114
Figure 10-21:	Menu: "Tar, Tariff meter"	116
Figure 10-22:	Menu: "Tar, Tariff meter 1"	116
Figure 10-23:	Menu: "Tariffs, Settings"	117
Figure 10-24:	Menu: "Tariffs, Settings"	119
Figure 10-25:	Menu: "Settings, Digital output", "Alarm" function	122
Figure 10-26:	Logic gate with AND operator	123
Figure 10-27:	Logic gate with NAND operator	123
Figure 10-28:	Logic gate with OR operator	124
Figure 10-29:	Logic gate with NOR operator	124
Figure 10-30:	Logic gate with XOR operator	124
Figure 10-31:	Logic gate with NXOR operator	125
Figure 10-32:	Menu: "Logging"	126
Figure 10-33:	"Menu: Logging, Settings"	127
Figure 10-34:	Menu: "Logging, Saved data"	128
Figure 10-35:	Execution of a firmware update	129

Figure 10-36:	Progress and state	130
---------------	--------------------------	-----

Section 11

Figure 11-1:	Topology	136
Figure 11-2:	Connections and designations	137
Figure 11-3:	Modbus status	138
Figure 11-4:	Modbus settings	139
Figure 11-5:	“Options, Manage general station description files (GSD)”	142
Figure 11-6:	Installing the station description file	143
Figure 11-7:	Dialog: “Manage general station description files”	144
Figure 11-8:	“Devices & networks” in the network view	145
Figure 11-9:	Selecting the EMpro from the hardware catalog	146
Figure 11-10:	Adding the EMpro to network view	147
Figure 11-11:	EMpro in the network view	148
Figure 11-12:	Assigning an I/O controller to the EMpro	149
Figure 11-13:	Selecting the I/O controller	149
Figure 11-14:	Networking controller and energy measuring device	150
Figure 11-15:	Adding a module to the device overview	151
Figure 11-16:	Submodules in the hardware catalog	152
Figure 11-17:	Inserting submodules	153
Figure 11-18:	Available modules and submodules	154
Figure 11-19:	Selecting a submodule in the device overview	155
Figure 11-20:	Creating PLC variables and connecting them with I/O variables	156
Figure 11-21:	“Assign device name”	157
Figure 11-22:	“Update list”	158
Figure 11-23:	“Assign name”	159
Figure 11-24:	Assigning a PROFINET device name	160
Figure 11-25:	Assigning a PROFINET device name	161
Figure 11-26:	Monitoring table	162
Figure 11-27:	Register table	167

A 2 List of tables

Section 2

Table 2-1:	Product overview	15
------------	------------------------	----

Section 4

Table 4-1:	Displaying the events.....	28
Table 4-2:	Meaning of the softkeys	29

Section 11

Table 11-1:	133
Table 11-2:	Adaptable parameters of the network interface.....	134
Table 11-3:	163
Table 11-4:	Modbus/TCP.....	163
Table 11-5:	Modbus gateway	163
Table 11-6:	PIN.....	164
Table 11-7:	8-bit integer types	165
Table 11-8:	16-bit integer types	165
Table 11-9:	32-bit integer types	165
Table 11-10:	32-bit IEE 754 floating point	165
Table 11-11:	ASCII strings.....	166

A 3 Index

Numerics

16-bit integer	165
1PH-2W-1CT	22
1PH-2W-1RC	25
2907944	15
2907945	15
2907946	15
2907953	15
2908285	15
2908286	15
2908301	15
2908302	15
2PH-2W-1CT	22
2PH-2W-1RC	25
2PH-3W-2CT	24
2PH-3W-2RC	26
32 bits	165
35 mm DIN rail	11
3PH-3W-1CT	23
3PH-3W-1RC	25
3PH-3W-2CT	23
3PH-3W-3CT	23
3PH-3W-3RC	25
3PH-4W-1CT	23
3PH-4W-1RC	26
3PH-4W-3CT	24
3PH-4W-3RC	26
8 bits	165

A

Acknowledging alarms	99
Acknowledgment of alarms	91
Activating PIN via display	37
Activating voltage input via web server	43
Activating voltage transducer via web server	44
Activation of gateway mode	163
Activation of Modbus/RTU	163
Activation of Modbus/TCP	163
Active energy	80, 81, 82
Active power	12
Alarm	
Digital output	101
Web server	108

Alarm acknowledgment via digital input	110
Alarm light	
Display	63
Alarm setting	
Web server	110
Amplitude transmission factor	42
AND operator	123
Apparent energy	80, 81, 82
Apparent power	12
Assembly of switchgear and controlgear	11
Assigning a PROFINET device name	160
Average value generation	84
Active power consumption, supply	84
Currents	84
Frequency	84
Voltages, phase to neutral conductor	84
Voltages, phase to phase	84
Average value synchronization	
Display	97
Web server	99
Average values	
Apparent power	84
Reactive power	84
Web server	85
AVG over fixed interval	84
AVG over rolling interval	84
AVG over sliding interval	84

B

Basic device configuration	31
Basic device configuration via display	31
Basic device configuration via the web server	37
Brightness adjustment	
Display	59
Broadcast messages	140

C

Change password	
Web server	71
Change PIN	
Display	70
Color change activation for alarm	
Display	63

EMpro - multi-functional energy measuring devices for front panel installation

Communication	133	Deactivation of digital output	
Communication interface		Modbus communication interface.....	106
Tariff selection	117	Web server	106
Configuration.....	163	Default gateway	37
Modbus/RTU	163	Default setting	
Configuration data		Contrast of display.....	58
Export.....	75	Digital input.....	92
Configuration of digital output		Digital output	101
Modbus communication interface.....	100	Display format	62
Web server.....	100	Language	51
Configuration overview via display	36	Password	71
Configuration overview via web server.....	45	PIN	70
Configuration via display	69	Refresh time for measured value display.....	64
Configuration via Modbus	69	Default setting, brightness	
Configuration via web server.....	69	Display	59
Configuring current input via web server	40	Default setting, illumination duration	
Connection (L/L)	21	Display	61
Connection (L/N).....	21	Device description file	142
Connections		Device name assignment.....	157
RS-485 interface	137	Device status	104
Contrast adjustment		Digital output	101
Display	58	Device supply.....	21
Contrast of display		DHCP.....	37
Default setting	58	DHCP protocol.....	133
Control desk.....	11	DHCP server	133
Control panel.....	11	Digital input	91
CRC	136	Default setting	92
Current sensors		Digital output	100
Current transformer	22	Default setting	101
Rogowski coil	25	Function	101
Current transformer (CT).....	22	Impulse.....	102
Cyclic redundancy check	136	Manual	106
		Web server	100
D		Digital output deactivation.....	114
Data logging.....	126	DIN rail adapters	11
Data types	165	Direct transfer of configuration data	77
Deactivated		Directly transferring configuration data.....	77
Digital output	101		
Deactivating	114		
Deactivating configuration			
Display	72		
Deactivating display and web server.....	72		
Deactivating Modbus communication interface.....	73		
Deactivation			
Display and web server	72		
Modbus communication interface.....	73		

Display		EEM-MA771-EIP.....	15
Activating PIN.....	37	EEM-MA771-PN.....	15
Alarm light.....	63	EEM-MA771-R.....	15
Brightness of display.....	59	Energy meter, resettable	
Change PIN.....	70	Display.....	81
Color change activation for alarm.....	63	Reset.....	81
Configuration.....	69	Energy meter, total	
Configuration overview.....	36	Display.....	80
Contrast adjustment.....	58	Ethernet interface.....	133
Deactivating configuration.....	72	EtherNet/IP.....	13
Default setting, brightness.....	59	EtherNet/IP™.....	133
Default setting, illumination duration.....	61	Exporting configuration data.....	75
Energy meter, resettable.....	81		
Energy meter, total.....	80	F	
Event display.....	28	Firmware update.....	129
Format selection for standard display.....	62	Fixed block.....	87
Grid type selection.....	33	Format selection for standard display	
IEC display format.....	62	Display.....	62
IEEE display format.....	62	Web server.....	65
Illumination duration setting for backlight.....	60	Front panel installation.....	11
Language selection.....	31, 51	Function	
Load operation.....	83	Modbus.....	135
Menu structure.....	47	Function check.....	162
Network settings.....	32	Function codes.....	135
Operating elements.....	29	Function of digital input	
Operating hours counter.....	83	Acknowledgment of alarms.....	91
Permanent light.....	61	Impulse counter.....	91
Read date and time.....	52	Synchronization of average values.....	91
Refresh time selection for measured values.....	64	Tariff selection.....	91
Resetting the energy meter.....	81	Functions.....	91
Setting PIN.....	36	Functions of digital input.....	91
Synchronization of average values.....	97		
Tariff meter.....	82	G	
Technical data.....	27	Gateway mode	
Display format		Activation.....	163
Default setting.....	62	GSDML file.....	142
DNS server.....	37	GSDML file integration.....	142
Dynamic IP configuration.....	133		
E		H	
Editing access data.....	70	Hardware integration.....	145
EEM-MA770.....	15	Holding register.....	135
EEM-MA770-EIP.....	15		
EEM-MA770-PN.....	15	I	
EEM-MA770-R.....	15	I/O variable.....	156
EEM-MA771.....	15	Idle level.....	100

IEC display format.....	62	Modbus.....	135
IEEE display format.....	62	Configuration.....	69
Illumination duration setting for backlight		Function.....	135
Display.....	60	Modbus address.....	163
Importing configuration data.....	76	Modbus communication interface	
Impulse		Resetting the energy meter.....	81
Digital output.....	101	Modbus gateway.....	140, 163
Impulse counter.....	91	Time-out.....	163
Web server.....	93	Modbus/RTU.....	13, 136
Input register.....	135	Activation.....	163
Installation location.....	11	Configuration.....	163
Internal resistance.....	42	Modbus/RTU slave.....	136
Interval with fixed measuring interval length.....	87, 89	Modbus/TCP.....	13, 140, 163
Interval with fixed measuring period length.....	89	Activation.....	163
Interval with rolling block.....	88	Modbus/TCP server.....	140
Interval with sliding measuring interval length.....	87	Module integration.....	151
Inversion.....	40, 42	Monitoring table.....	162
Invert I1.....	42	Mounting.....	17
IP address		Mounting types.....	11
Static.....	37	Multiple registers.....	135
IP addressing.....	133		
IPv4.....	32, 133	N	
		NAND operator.....	123
L		NetBios name service.....	134
Language		Network settings via display.....	32
Default setting.....	51	Network settings via web server.....	38
Language selection on the web server.....	49	NOR operator.....	124
Language selection via display.....	31, 51	NXOR operator.....	125
Linking process data.....	156		
Load meter.....	83	O	
Load operation		One-phase network, two conductors,	
Display.....	83	one current transformer.....	22
Logic gate.....	121	One-phase network, two conductors,	
		one Rogowski coil.....	25
M		Operating and indication elements.....	27
Manual		Operating elements	
Digital output.....	101	Display.....	29
Master/slave protocol.....	136	Operating hours counter	
MBAP.....	140	Display.....	83
Measuring technology.....	79	OR operator.....	124
Menu structure on the display.....	47		
Menu structure on the web server.....	48	P	
Meter readings		Password	
Web server.....	79	Default setting.....	71
		Permanent light	
		Display.....	61

PIN		RS-485 interface	
Default setting	70	Connections	137
Pin assignment		S	
Current transformer	19	Secondary current.....	40
Rogowski coil	20	Secondary voltage	44
PLC variable.....	156	Selecting grid type via web server.....	39
Prediction calculation		Selecting the grid type	
Equally weighted average	89	Display	33
Weighted average	89	Self-acknowledgment alarm.....	111
Primary current.....	40, 41	Set date and time manually	
Primary voltage	44	Web server	53
Product overview	15	Setting PIN via display	36
PROFINET	13, 133, 142	Single register	135
Pulse		Sliding average value	87
Web server.....	102	Sliding block.....	87
R		Sliding block.....	87
Reactive energy	80, 81, 82	Start screen of the web server.....	49
Reactive power	12	Static IP address	37
Read date and time		Static IP configuration	133
Display	52	Statistics.....	84
Read holding registers	135	Status of communication interface	135
Read input registers.....	135	Subinterval	88
Refresh time for measured value display		Submodule integration	151
Default setting	64	Subnet mask	37
Refresh time selection for measured values		Summer time rule	57
Display	64	Supply voltage range	21
Register.....	165	Synchronization of average values.....	91
Register table.....	14, 167	Display	97
Reset		Web server	99
Energy meter, resettable	81	Synchronize time and date with an SNTP server	
Tariff meter	82	Web server	54
Resetting the energy meter		T	
Display	81	Tariff meter	
Modbus communication interface.....	81	Display	82
Web server.....	81	Reset.....	82
RJ45 interface	133	Tariff selection.....	91
RJ45 socket	133	Display	116
Rogowski coil (RCP)	25	Web server	95
Rolling average value.....	88	Tariff selection using time schedule	118
Rolling block.....	88	Tariff selection via communication interface.....	117
Rolling block.....	88		
Rotary field direction			
Digital output	101		
Rotary field direction detection.....	112		
RS-485.....	133		

Technical data.....	173	Two-phase network, two conductors, one current transformer.....	22
Ambient conditions.....	176	Two-phase network, two conductors, one Rogowski coil.....	25
Conformance/approvals.....	176	W	
Connection data.....	176	WBM active.....	74
Current measurement, current transformer.....	174	web.....	85
Current measurement, Rogowski coil direct connection.....	174	Web server	
Date and time.....	176	Activating voltage input.....	43
Digital input.....	175	Activating voltage transducer.....	44
Digital output in accordance with 61131-2 (type 3).....	175	Alarm.....	108
Dimensions.....	173	Alarm setting.....	110
Display.....	27	Average values.....	85
Fuses.....	176	Basic device configuration.....	37
Galvanic isolation.....	175	Change password.....	71
General data.....	173	Configuration.....	69
Power measurement.....	174	Configuration overview.....	45
Supply.....	175	Configuring current input.....	40
Voltage measurement.....	173	Digital output.....	100
Three-phase network, four conductors, one current transformer.....	23	Format selection for standard display.....	65
Three-phase network, four conductors, one Rogowski coil.....	26	Impulse.....	102
Three-phase network, four conductors, three current transformers.....	24	Impulse counter.....	93
Three-phase network, four conductors, three Rogowski coils.....	26	Language selection.....	49
Three-phase network, three conductors, one current transformer.....	23	Menu structure.....	48
Three-phase network, three conductors, one Rogowski coil.....	25	Meter readings.....	79
Three-phase network, three conductors, three current transformers.....	23	Network settings.....	38
Three-phase network, three conductors, three Rogowski coils.....	25	Resetting the energy meter.....	81
Three-phase network, three conductors, two current transformers.....	23	Selecting grid type.....	39
TIA portal.....	142	Set date and time manually.....	53
Time zones.....	55	Start screen.....	49
Time-out		Synchronization of average values.....	99
Modbus gateway.....	163	Synchronize time/date, with an SNTP server.....	54
Topology.....	136	Tariff selection.....	95
Transferring configuration data.....	75	Write multiple register.....	135
True r.m.s. value measurement.....	12	Write single register.....	135
Two-phase network, three conductors, two current transformers.....	24	X	
Two-phase network, three conductors, two Rogowski coils.....	26	XOR operator.....	124

Please observe the following notes

General terms and conditions of use for technical documentation

Phoenix Contact reserves the right to alter, correct, and/or improve the technical documentation and the products described in the technical documentation at its own discretion and without giving prior notice, insofar as this is reasonable for the user. The same applies to any technical changes that serve the purpose of technical progress.

The receipt of technical documentation (in particular user documentation) does not constitute any further duty on the part of Phoenix Contact to furnish information on modifications to products and/or technical documentation. You are responsible to verify the suitability and intended use of the products in your specific application, in particular with regard to observing the applicable standards and regulations. All information made available in the technical data is supplied without any accompanying guarantee, whether expressly mentioned, implied or tacitly assumed.

In general, the provisions of the current standard Terms and Conditions of Phoenix Contact apply exclusively, in particular as concerns any warranty liability.

This manual, including all illustrations contained herein, is copyright protected. Any changes to the contents or the publication of extracts of this document is prohibited.

Phoenix Contact reserves the right to register its own intellectual property rights for the product identifications of Phoenix Contact products that are used here. Registration of such intellectual property rights by third parties is prohibited.

Other product identifications may be afforded legal protection, even where they may not be indicated as such.

How to contact us

Internet

Up-to-date information on Phoenix Contact products and our Terms and Conditions can be found on the Internet at:

phoenixcontact.com

Make sure you always use the latest documentation.

It can be downloaded at:

phoenixcontact.net/products

Subsidiaries

If there are any problems that cannot be solved using the documentation, please contact your Phoenix Contact subsidiary.

Subsidiary contact information is available at phoenixcontact.com.

Published by

PHOENIX CONTACT GmbH & Co. KG

Flachsmarktstraße 8

32825 Blomberg

GERMANY

PHOENIX CONTACT Development and Manufacturing, Inc.

586 Fulling Mill Road

Middletown, PA 17057

USA

Should you have any suggestions or recommendations for improvement of the contents and layout of our manuals, please send your comments to:

tecdoc@phoenixcontact.com

PHOENIX CONTACT GmbH & Co. KG
Flachmarktstraße 8
32825 Blomberg, Germany
Phone: +49 5235 3-00
Fax: +49 5235 3-41200
E-mail: info@phoenixcontact.com
phoenixcontact.com