

ZMV Series Mini Size Snap-acting Switches

NEW



UL61058-1



Features/Benefits

- Compact size – ideal when space is limited
- High contact reliability to support from low range switching loads
- Adequate stroke setting for reliable & precision ON or OFF switching
- Pin plunger version can be actuated from an angle
- Internal spring design return – ensures the actuator is restored to the same position every time. These features yield consistent operation over the long life of these switches.
- IP67 for standalone switch except the metal terminal part; Full IP67 protection when potted with wire version
- RoHS compatible & compliant

Typical Applications

- Automotive: door latch, seat position detection, EV charging
- Medical
- Industrial
- Home appliances
- IoT devices

Specifications

CONTACT RATING: 3A 12VDC @ 100,000 cycles min.
 3A 24VDC @ 50,000 cycles min.
 3A 125/250VAC @ 10,000 cycles min.
 0.01A 12/24VDC @ 1,000,000 cycles min.
 0.01A 125/250VAC @ 1,000,000 cycles min.

MECHANICAL LIFE: 1,000,000 cycles min.
 INSULATION RESISTANCE: 100 MΩ min.
 DIELECTRIC STRENGTH: Min. 500VAC (50-60Hz)/minute between Live Parts
 OPERATING TEMPERATURE: -40°C to 85°C
 OPERATING FORCE: 150 gf max.

Materials

CASE: Nylon
 COVER: Nylon
 ACTUATOR BUTTON: PET+POM
 MOVABLE CONTACTS: AG alloy (Gold plated if selected)
 STATIONARY CONTACTS: AG alloy (Gold plated if selected)
 TERMINALS: Brass

NOTE: Specifications and materials listed above are for switches with standard options. For information on specific and custom switches, consult Customer Service Center.

⚠ Sealing cap could possibly be damaged in case of contacts with oils or greases. Please try to avoid direct contact. If more support is needed, consult Customer Service Centre.

Build-A-Switch

Our easy build-a-switch concept allows you to mix and match options to create the switch you need. To order, select desired option from each category and place it in the appropriate box.

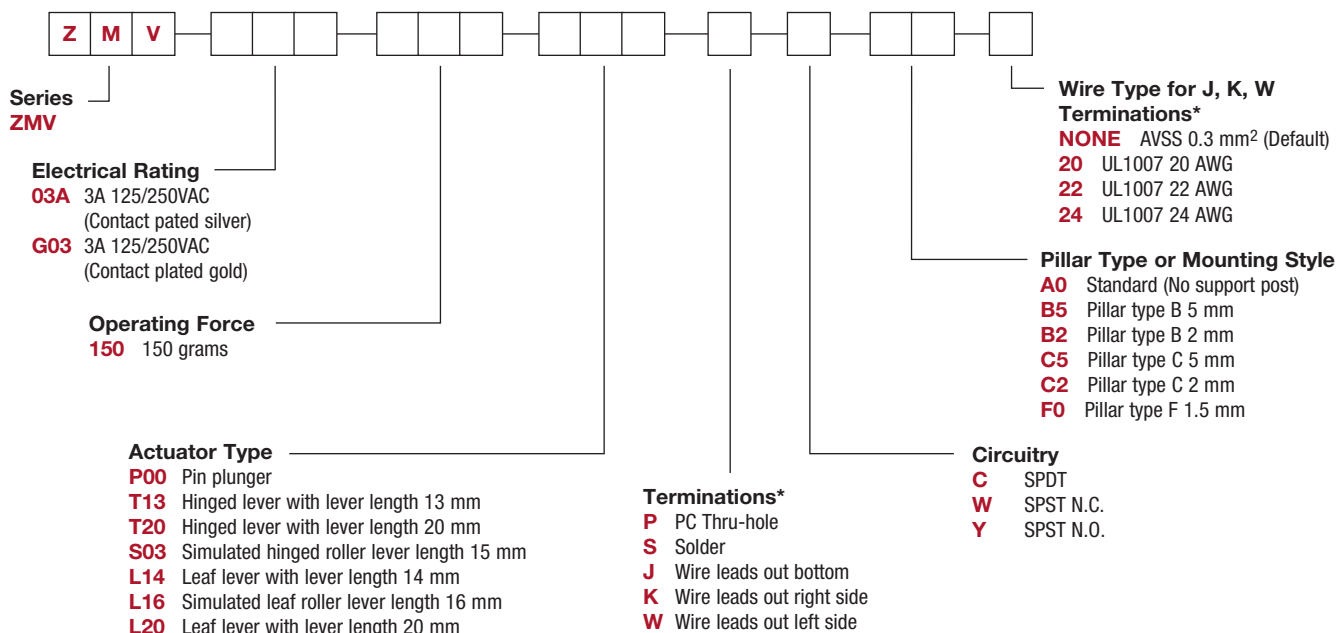

Snap-acting

NEW

ZMV Series Mini Size Snap-acting Switches

SERIES

ZMV MINI SIZE SNAP-ACTING SWITCHES

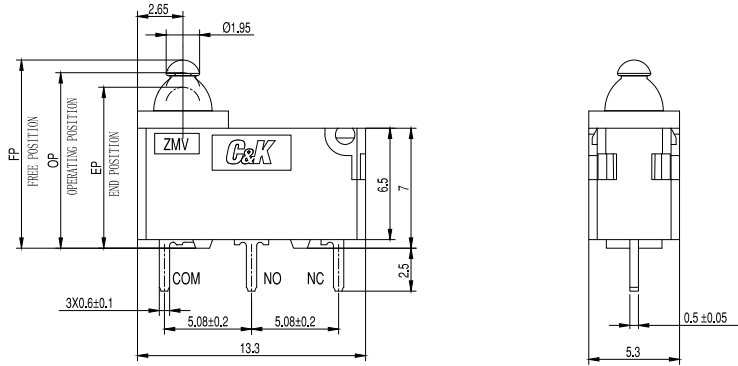

ACTUATOR TYPE

P00 PIN PLUNGER

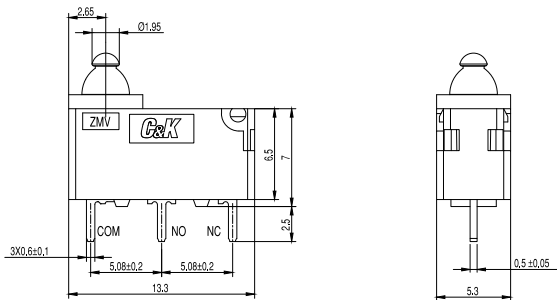

T13 HINGED LEVER WITH LEVER LENGTH 13 MM

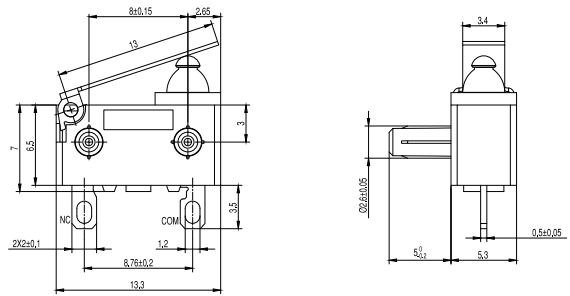

T20 HINGED LEVER WITH LEVER LENGTH 20 MM

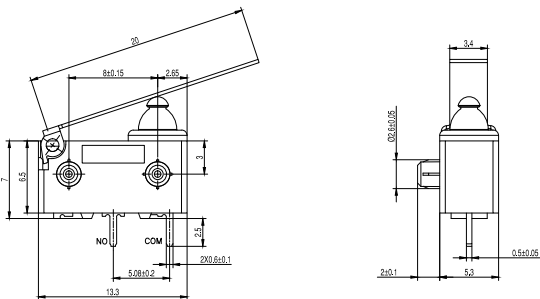

S03 SIMULATED HINGED ROLLER LEVER LENGTH 15 MM

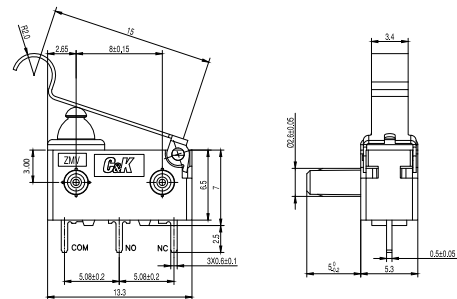

Snap-acting



ZMV Series Mini Size Snap-acting Switches

NEW

ACTUATOR TYPE

L14 LEAF LEVER WITH LEVER LENGTH 14 MM

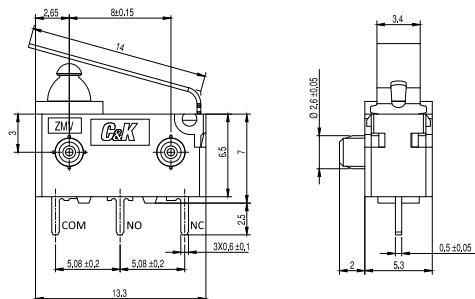

L16 SIMULATED LEAF ROLLER LEVER LENGTH 16 MM

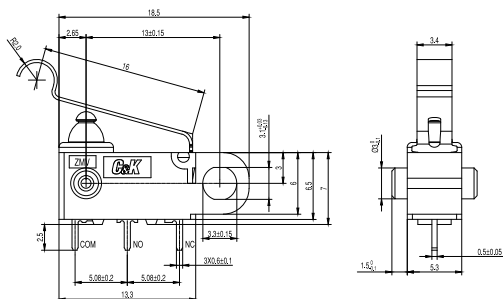

L20 LEAF LEVER WITH LENGTH 20 MM

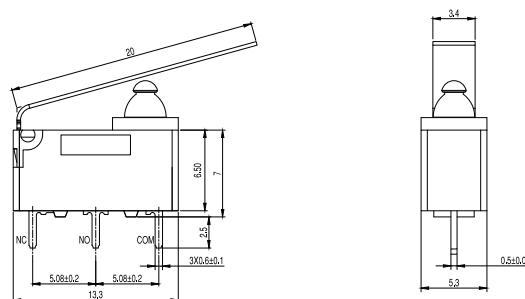

Snap-acting

NEW

ZMV Series Mini Size Snap-acting Switches

TERMINATIONS

P PC THRU-HOLE

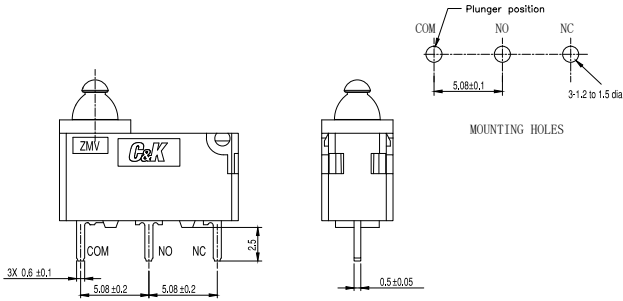

S SOLDER

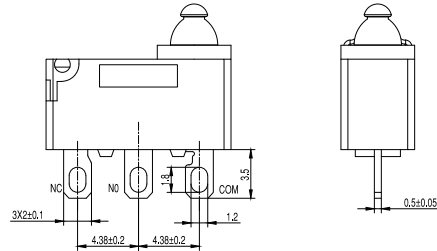

J WIRE LEADS OUT BOTTOM

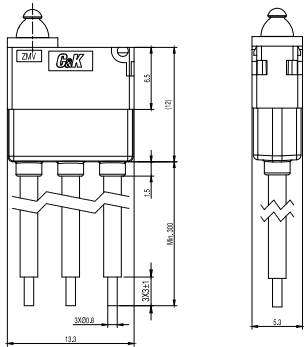

Default wire:
 COM: AVSS 0.3 MM² BLACK OR EQUIVALENT
 NO: AVSS 0.3 MM² BLUE OR EQUIVALENT
 NC: AVSS 0.3 MM² GRAY OR EQUIVALENT

K WIRE LEADS OUT RIGHT SIDE

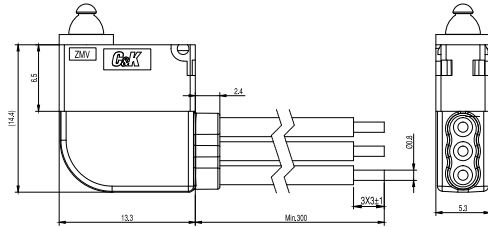

Default wire:
 COM: AVSS 0.3 MM² BLACK OR EQUIVALENT
 NO: AVSS 0.3 MM² BLUE OR EQUIVALENT
 NC: AVSS 0.3 MM² GRAY OR EQUIVALENT

W WIRE LEADS OUT LEFT SIDE

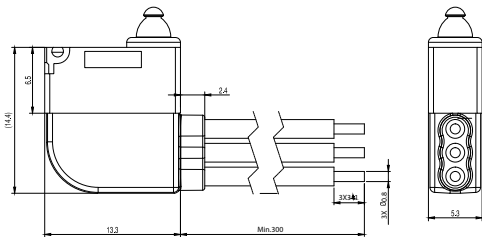

Default wire:
 COM: AVSS 0.3 MM² BLACK OR EQUIVALENT
 NO: AVSS 0.3 MM² BLUE OR EQUIVALENT
 NC: AVSS 0.3 MM² GRAY OR EQUIVALENT



Snap-acting



ZMV Series Mini Size Snap-acting Switches

NEW

PILLAR TYPE OR MOUNTING STYLE

A0 STANDARD (NO SUPPORT POST)

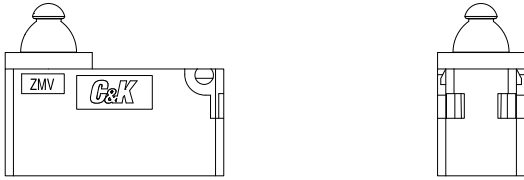

B5 PILLAR TYPE B 5 MM

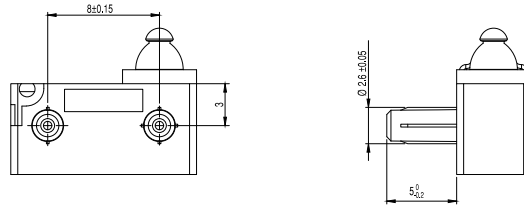

B2 PILLAR TYPE B 2 MM

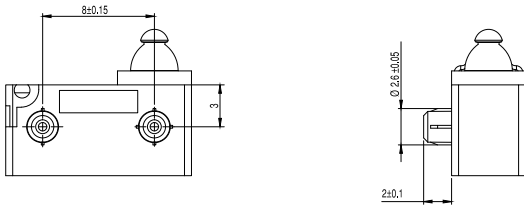

C5 PILLAR TYPE C 5 MM

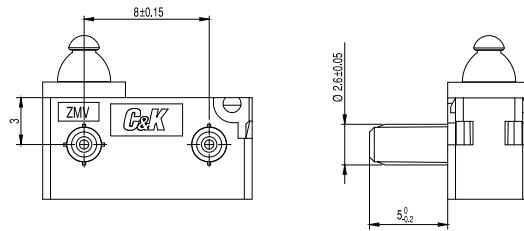

C2 PILLAR TYPE C 2 MM

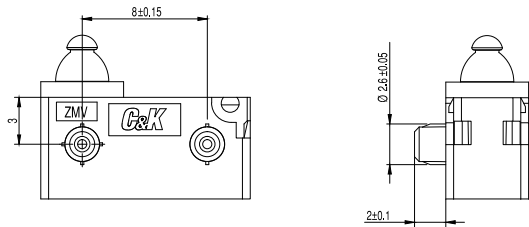

F0 PILLAR TYPE F 1.5 MM

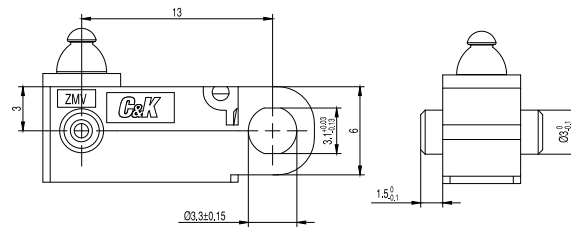







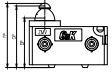
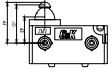
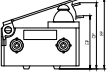
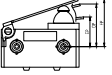
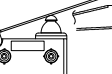
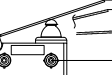

Snap-acting

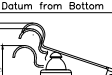
NEW

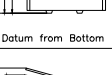
ZMV Series Mini Size Snap-acting Switches

SWITCH CHARACTERISTICS

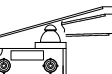
SWITCH TYPE	PART SUFFIX	OF Max (gf)	FP Max (mm)	OP (mm)	EP Min (mm)	OT Min (mm)	MD Max (mm)	RF Min (gf)
ZMVXXX150P00XXXX	 Datum from Bottom	150	11.2	10.4±0.2	9.1	1.1	0.25	20
	 Datum from Centre		7.2	6.4±0.2	5.1			
ZMVXXX150T13XXXX	 Datum from Bottom	150	12.8	11.5±0.5	10	1.0	0.5	13
	 Datum from Centre		8.8	7.5±0.5	6			
ZMVXXX150T20XXXX	 Datum from Bottom	95	15.5	13.3±0.8	11	1.5	0.8	6
	 Datum from Centre		11.5	9.3±0.8	7			
ZMVXXX150S03XXXX	 Datum from Bottom	120	16.5	15.2±0.5	13.5	1.2	0.5	10
	 Datum from Centre		12.5	11.2±0.5	9.5			
ZMVXXX150L14XXXX	 Datum from Bottom	220	13.3	11.4±0.5	9.8	1.1	0.5	38
	 Datum from Centre		9.3	7.4±0.5	5.8			
ZMVXXX150L16XXXX	 Datum from Bottom	200	16.5	14.8±0.5	12.9	1.4	0.5	38
	 Datum from Centre		12.5	10.8±0.5	8.9			
ZMVXXX150L20XXXX	 Datum from Bottom	168	15.5	12.2±0.8	9.9	1.5	0.8	30
	 Datum from Centre		11.5	8.2±0.8	5.9			

OF: Operating force
EP: End position
RF: Release force

FP: Free position
OT: Overtravel

OP: Operating position
MD: Differential motion

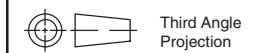

Third Angle
Projection

Dimensions are shown: mm
Specifications and dimensions subject to change



Snap-acting