

Sure Cross® Performance PM2 Node with Mapping



Datasheet

The Sure Cross® wireless system is a radio frequency network with integrated I/O that operates in most environments to eliminate the need for wiring runs.



WARNING:

- **Do not use this device for personnel protection**
- Using this device for personnel protection could result in serious injury or death.
- This device does not include the self-checking redundant circuitry necessary to allow its use in personnel safety applications. A device failure or malfunction can cause either an energized (on) or de-energized (off) output condition.



Important:

- **Never operate a 1 Watt radio without connecting an antenna**
- Operating 1 Watt radios without an antenna connected will damage the radio circuitry.
- To avoid damaging the radio circuitry, never apply power to a Sure Cross® Performance or Sure Cross MultiHop (1 Watt) radio without an antenna connected.



Important:

- **Electrostatic discharge (ESD) sensitive device**
- ESD can damage the device. Damage from inappropriate handling is not covered by warranty.
- Use proper handling procedures to prevent ESD damage. Proper handling procedures include leaving devices in their anti-static packaging until ready for use; wearing anti-static wrist straps; and assembling units on a grounded, static-dissipative surface.



Important: Please download the complete Performance Gateway or Node technical documentation, available in multiple languages, from www.bannerengineering.com for details on the proper use, applications, Warnings, and installation instructions of this device.



Important: Por favor descargue desde www.bannerengineering.com toda la documentación técnica de los Performance Gateway or Node, disponibles en múltiples idiomas, para detalles del uso adecuado, aplicaciones, advertencias, y las instrucciones de instalación de estos dispositivos.



Important: Veuillez télécharger la documentation technique complète des Performance Gateway or Node sur notre site www.bannerengineering.com pour les détails sur leur utilisation correcte, les applications, les notes de sécurité et les instructions de montage.

Models

Models	Frequency	Environmental Rating	I/O
DX80N9X6S-PM2	900 MHz ISM Band	IP67, NEMA 6	Inputs: Four selectable discrete, two 0–20 mA Outputs: Four PNP discrete, two 0–20 mA analog I/O is automatically mapped to the PM2 Gateway using the Gateway's menu system
DX80N2X6S-PM2	2.4 GHz ISM Band		



DX80...C (IP20; NEMA 1) models are also available. To order this model with an IP20 housing, add a C to the end of the model number: DX80N9X6S-PM2C.



Configuration Instructions

Configure the DIP Switches

Before changing DIP switch positions, disconnect the power. Any changes made to the DIP switches are not recognized until after power is cycled to the device.

Access the Internal DIP Switches

Follow these steps to access the internal DIP switches.

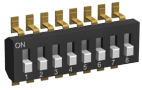

1. Unscrew the four screws that mount the cover to the bottom housing.
2. Remove the cover from the housing without damaging the ribbon cable or the pins the cable plugs into.
3. Gently unplug the ribbon cable from the board mounted into the bottom housing. For integrated battery models (no ribbon cable), C housing models (ribbon cable is glued down), and Class I, Division 2 certified devices (ribbon cable is glued down), skip this step.
4. Remove the black cover plate from the bottom of the device's cover.
The DIP switches are located behind the rotary dials.
5. Make the necessary changes to the DIP switches.
6. Place the black cover plate back into position and gently push into place.
7. If necessary, plug the ribbon cable in after verifying that the blocked hole lines up with the missing pin.
8. Mount the cover back onto the housing.

DIP Switch Settings

Device Settings	Switches					
	1	2	3	4	5	6 ¹
900 MHz transmit power level: 1 Watt (30 dBm)	OFF*					
900 MHz transmit power level: 250 mW (24 dBm), DX80 compatibility mode	ON					
Modbus or UCT configured (overrides DIP switches 3-8)		OFF*				
DIP switch configured		ON				
Inputs sourcing (PNP)			OFF*			
Inputs sinking (NPN)			ON			
Link loss output: zero				OFF*	OFF*	
Link loss output: one				OFF	ON	
Link loss output: hold last state				ON	OFF	
Link loss output: user configuration				ON	ON	
0 to 20 mA scale						OFF*
4 to 20 mA scale						ON

* Default configuration

Analog Input and Output Scale

Use the DIP switch to select which current scale to use for all the device's analog inputs and outputs: 0 to 20 mA or 4 to 20 mA. When using a 4-20 mA sensor with a 0-20 mA input, the sensor uses the 4-20 mA section of the total range. Using a 4-20 mA with a 0-20 mA input allows you to determine when you have an error condition with the sensor. A normal input reading between 4 and 20 mA indicates a functioning sensor whereas a value below 4 mA indicates an error condition, such as a broken wire or loose connection. This DIP switch is used only on the 0 to 20 mA models, not the 0 to 10V models.

Discrete Input Type

Select the type of discrete input sensors to use with this device: sourcing (PNP) sensors or sinking (NPN) sensors.

¹ Not used when configured for 0-10 V I/O.

Link Loss Outputs

The Sure Cross® wireless devices use a deterministic radio link time-out method to address RF link interruption or failure. When a radio link fails, all pertinent wired outputs are set to defined states until the link is recovered, ensuring that disruptions in the communications link result in predictable system behavior.

Following a radio link time-out, all outputs linked to the Node in question are set to de-energize (discrete outputs to zero, analog outputs to 0 mA or 4 mA), energize (discrete outputs to one, analog outputs to 20 mA), or hold the last stable state/value. Use the DIP switches to select the link loss output state.

Modbus/Software or DIP Switch Configured

In Modbus/Software Configured mode, use the User Configuration Software or a Modbus command to change the device parameters. DIP switch positions 3 through 8 are ignored. In DIP Switch Configured mode, use the DIP switches to configure the parameters listed in the table.

Transmit Power Levels

The 900 MHz radios transmit at 1 Watt (30 dBm) or 250 mW (24 dBm). While the Performance radios operate in 1 Watt mode, they cannot communicate with the older 150 mW radios. To communicate with 150 mW radios, operate this radio in 250 mW mode. For 2.4 GHz models, this DIP switch is disabled. The transmit power for 2.4 GHz is fixed at about 65 mW EIRP (18 dBm), making the 2.4 GHz Performance models automatically compatible with older 2.4 GHz models.

Wire Your Sure Cross® Device

Use the following wiring diagrams to first wire the sensors and then apply power to the Sure Cross devices.

Terminal Blocks (PM2 and PM2C Models)

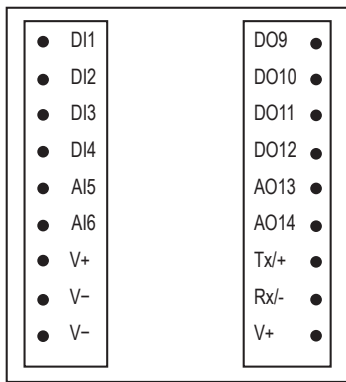

- AIx. Analog IN *x*.
- AOx. Analog OUT *x*.
- DIx. Discrete IN *x*.
- DOx. Discrete OUT *x*.
- RX/-. Serial communication line for the Gateway. No connection for Nodes TX/+.
- TX/+. Serial communication line for the Gateway; no connection for Nodes V+.
- V+. 10 to 30 V DC power connection
- V-. Ground/DC common connection

(-PM2 board shown)

Connecting power to the communication pins will cause permanent damage. For the DX8x...C models, PWR in the wiring diagram refers to V+ on the wiring board and GND in the wiring diagram refers to V- on the wiring board.

Do not exceed analog input ratings for analog inputs. Only connect sensor outputs to analog inputs.

To power the sensor using the switch power output (SPx), replace the PWR with SPx in these wiring diagrams.

Refer to the Class I Division 2/Zone 2 control drawings (p/n 143086) for wiring specifications and limitations.

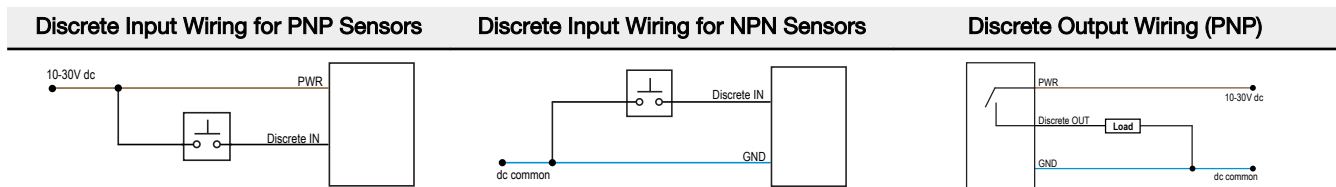

Analog Input Wiring (10–30 V DC Power) Analog Input Wiring (4–20 mA, 2-Wire, Externally-Powered Sensors) Analog Output Wiring

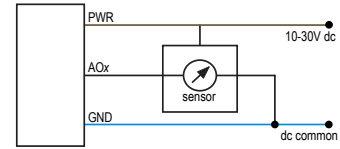
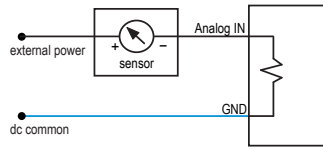
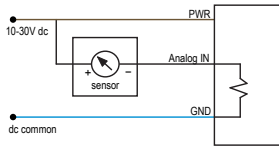

Bind the DX80 Nodes to the DX80 Gateway and Assign the Node Address

Before beginning the binding procedure, apply power to all the devices. Separate radios by 2 meters when running binding procedure. Put only one Gateway into binding at a time to prevent binding to the wrong Gateway.

1. Enter binding mode on the Gateway.
 - For housed DX80 Gateways, triple-click the right-hand button. LEDs alternately flash red.
 - For board level DX80 Gateways, triple-click the binding button. LED flashes green and red.
2. Use both of the Node's rotary dials to assign the Node Address defined in the Gateway's datasheet. The left rotary dial represents the tens digit (0 through 4) and the right dial represents the ones digit (0 through 9) of the Node Address.
3. To enter binding mode on the Node, triple-click button 2. The Node enters binding mode and locates the Gateway in binding mode. The red LEDs flash alternately. The Node automatically exits binding mode. After the Node is bound, the LEDs are both solid red for a few seconds. The Node cycles its power, then enters Run mode. For the pre-mapped kits, the Node's rotary dials must be set based on the mapping defined by the Gateway. For more information, refer to the mapping tables in the MAPIO Menu section of the Gateway's datasheet.
4. Label the Node with the assigned address for future references.
5. Repeat steps 2 through 4 for all Nodes that need to communicate to this Gateway.
6. Exit binding mode on the Gateway by single-clicking either button 1 or button 2.

For Gateways with single line LCDs, after binding your Nodes to the Gateway, make note of the binding code displayed under the Gateway's *DVCFG menu, XADR submenu on the LCD. Knowing the binding code prevents having to re-bind all Nodes if your Gateway is ever replaced.

LED Behavior for the Nodes

Nodes do not sample inputs until they are communicating with the Gateway. The radios and antennas must be a minimum distance apart to function properly. Recommended minimum distances are:

- 900 MHz 150 mW and 250 mW radios: 6 feet
- 900 MHz 1 Watt radios: 15 feet
- 2.4 GHz 65 mW radios: 1 foot

LED 1	LED 2	Node Status
Flashing green		Radio Link Ok
Flashing red	Flashing red	Device Error
	Flashing red, 1 per 3 sec	No Radio Link

Installing Your Sure Cross® Radios

Please refer to one of the following instruction manuals for details about successfully installing your wireless network components.

- Performance Wireless I/O Network Instruction Manual: [132607](#)

Modbus Registers

I/O	Modbus Holding Register		I/O Type	I/O Range		Holding Register Representation	
	Gateway	Any Node		Min. Value	Max. Value	Min. (Dec.)	Max. (Dec.)
1	1	1 + (Node# × 16)	Discrete IN 1	0	1	0	1
2	2	2 + (Node# × 16)	Discrete IN 2	0	1	0	1
3	3	3 + (Node# × 16)	Discrete IN 3	0	1	0	1
4	4	4 + (Node# × 16)	Discrete IN 4	0	1	0	1

I/O	Modbus Holding Register		I/O Type	I/O Range		Holding Register Representation	
	Gateway	Any Node		Min. Value	Max. Value	Min. (Dec.)	Max. (Dec.)
5	5	5 + (Node# × 16)	Analog IN 5 (mA)	0.0	20.0	0	65535
6	6	6 + (Node# × 16)	Analog IN 6 (mA)	0.0	20.0	0	65535
7	7	7 + (Node# × 16)	Reserved				
8	8	8 + (Node# × 16)	Device Message				
9	9	9 + (Node# × 16)	Discrete OUT 9	0	1	0	1
10	10	10 + (Node# × 16)	Discrete OUT 10	0	1	0	1
11	11	11 + (Node# × 16)	Discrete OUT 11	0	1	0	1
12	12	12 + (Node# × 16)	Discrete OUT 12	0	1	0	1
13	13	13 + (Node# × 16)	Analog OUT 13 (mA)	0.0	20.0	0	65535
14	14	14 + (Node# × 16)	Analog OUT 14 (mA)	0.0	20.0	0	65535
15	15	15 + (Node# × 16)	Control Message				
16	16	16 + (Node# × 16)	Reserved				

Specifications

Performance Radio Specifications

Radio Range²

900 MHz, 1 Watt: Up to 9.6 km (6 miles)
 2.4 GHz, 65 mW: Up to 3.2 km (2 miles)

Antenna Minimum Separation Distance

900 MHz, 1 Watt: 4.57 m (15 ft)
 2.4 GHz, 65 mW: 0.3 m (1 ft)

Radio Transmit Power

900 MHz, 1 Watt: 30 dBm (1 W) conducted (up to 36 dBm EIRP)
 2.4 GHz, 65 mW: 18 dBm (65 mW) conducted, less than or equal to 20 dBm (100 mW) EIRP

Spread Spectrum Technology

FHSS (Frequency Hopping Spread Spectrum)

900 MHz Compliance (1 Watt)

FCC ID UE3RM1809: FCC Part 15, Subpart C, 15.247
 IC: 7044A-RM1809
 IFT: RCPBARM13-2283

2.4 GHz Compliance

FCC ID UE300DX80-2400: FCC Part 15, Subpart C, 15.247
 Radio Equipment Directive (RED) 2014/53/EU
 IC: 7044A-DX8024

Antenna Connection

Ext. Reverse Polarity SMA, 50 Ohms
 Max Tightening Torque: 0.45 N-m (4 lbf-in)

Link Timeout

Gateway: Configurable via User Configuration Software
 Node: Defined by Gateway

Specifications

Supply Voltage

10 V DC to 30 V DC (Outside the USA: 12 V DC to 24 V DC, ± 10%)³

Wiring Access

Two 1/2-in NPT

Housing

Polycarbonate housing and rotary dial cover; polyester labels; EDPM rubber cover gasket; nitrile rubber, non-sulphur cured button covers
 Weight: 0.26 kg (0.57 lbs)
 Mounting: #10 or M5 (SS M5 hardware included)
 Max. Tightening Torque: 0.56 N-m (5 lbf-in)

Interface

Two bi-color LED indicators, Two buttons, Six character LCD

² Radio range is with the 2 dB antenna that ships with the product. High-gain antennas are available, but the range depends on the environment and line of sight. Always verify your wireless network's range by performing a Site Survey.

³ For European applications, power this device from a Limited Power Source as defined in EN 60950-1.

Discrete Inputs

Four, DIP switch selectable between PNP and NPN
 Rating: 3 mA max current at 30 V DC
 Sample Rate: 62.5 milliseconds
 Report Rate: On change of state

Discrete Input ON Condition

PNP: Greater than 8 V
 NPN: Less than 0.7 V

Discrete Input OFF Condition

PNP: Less than 5 V
 NPN: Greater than 2 V or open

Analog Inputs

Two, 0 to 20 mA
 Input Rating: 24 mA
 Impedance: Approximately 220 Ohms
 Sample Rate: 62.5 milliseconds
 Report Rate: 1 second or On Change of State (1% change in value)
 Accuracy: 0.2% of full scale +0.01% per °C
 Resolution: 12-bit

Certifications

(CE approval only applies to 2.4 GHz models)



(NOM approval only applies to 900 MHz models)

Discrete Outputs

Four PNP
 Update Rate: 125 milliseconds
 ON Condition: Supply minus 2 V
 OFF Condition: Less than 2 V
 Output State Following Timeout: OFF

Discrete Output Rating (PNP)

100 mA max current at 30 V DC
 ON-State Saturation: Less than 3 V at 100 mA
 OFF-state Leakage: Less than 10 µA

Analog Outputs

Two, 0 to 20 mA
 Update Rate: 125 milliseconds
 Accuracy: 0.1% of full scale +0.01% per °C
 Resolution: 12-bit

Certifications for DX8x...C (External Wiring Terminal) and DX8x...E Models

CSA: Class I Division 2 Groups ABCD, Class I Zone 2 AEx/Ex nA II T4 – Certificate: 1921239



ATEX: II 3 G Ex nA IIC T4 Gc (Group IIC Zone 2) – Certificate LCIE 10 ATEX 1012 X

Refer to the Class I Division 2/Zone 2 control drawings (p/n [143086](#)) for wiring specifications and limitations. Install the device in a suitable enclosure with provision for connection of Division 2 / Zone 2 wiring methods in accordance with local codes, as acceptable to the local inspection authority having jurisdiction. All battery-powered devices must only use the lithium battery manufactured by Xeno, model XL-205F (Banner model number **BWA-BATT-001**).

Environmental Specifications

Operating Conditions

–40 °C to +85 °C (–40 °F to +185 °F) (Electronics); –20 °C to +80 °C (–4 °F to +176 °F) (LCD)
 95% maximum relative humidity (non-condensing)
 Radiated Immunity: 10 V/m (EN 61000-4-3)

Shock and Vibration

All models meet IEC 60068-2-6 and IEC 60068-2-27 testing criteria
 Shock: 30G 11 ms duration, half sine wave per IEC 60068-2-27
 Vibration: 10 Hz to 55 Hz, 0.5 mm peak-to-peak amplitude per IEC 60068-2-6

Environmental Ratings

IEC IP67; NEMA 6
 Refer to the Sure Cross® Wireless I/O Networks Instruction Manual (p/n [132607](#)) for installation and waterproofing instructions.

Operating the devices at the maximum operating conditions for extended periods can shorten the life of the device.

Environmental Specifications for the C Housings

Operating Conditions

–40 °C to +85 °C (–40 °F to +185 °F) (Electronics); –20 °C to +80 °C (–4 °F to +176 °F) (LCD)
 95% maximum relative humidity (non-condensing)
 Radiated Immunity: 10 V/m (EN 61000-4-3)

Shock and Vibration

All models meet IEC 60068-2-6 and IEC 60068-2-27 testing criteria
 Shock: 30G 11 ms duration, half sine wave per IEC 60068-2-27
 Vibration: 10 Hz to 55 Hz, 0.5 mm peak-to-peak amplitude per IEC 60068-2-6

Environmental Ratings

"C" Housing Models/External wiring terminals: IEC IP20; NEMA 1
 Refer to the Sure Cross® Wireless I/O Networks Instruction Manual (p/n [132607](#)) for installation and waterproofing instructions.

Operating the devices at the maximum operating conditions for extended periods can shorten the life of the device.

Accessories

Mounting Brackets

BWA-BK-020

- Includes two 80-lb pull rare-earth magnet mounts and two #10-32 x 1 inch screw mounts
- Used on multiple mounting brackets
- 31.75 mm (1.25 inch) diameter

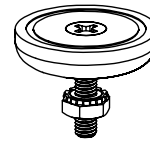

Included with Model

The following items ship with the PM2 and PM8 radios.

- One 1/2-inch NPT plug (not included with IP20 "C" models)
- Two 1/2-inch nylon gland fittings (not included with IP20 "C" models)
- **BWA-902-C** (900 MHz) or **BWA-202-C** (2.4 GHz) Antenna, 2 dBd Omni, Rubber Swivel RP-SMA Male
- **BWA-HW-011** IP20 Screw Terminal Headers (2 pack) (IP20 "C" models only)

Warnings

Install and properly ground a qualified surge suppressor when installing a remote antenna system. Remote antenna configurations installed without surge suppressors invalidate the manufacturer's warranty. Keep the ground wire as short as possible and make all ground connections to a single-point ground system to ensure no ground loops are created. No surge suppressor can absorb all lightning strikes; do not touch the Sure Cross® device or any equipment connected to the Sure Cross device during a thunderstorm.

Exporting Sure Cross® Radios. It is our intent to fully comply with all national and regional regulations regarding radio frequency emissions. **Customers who want to re-export this product to a country other than that to which it was sold must ensure the device is approved in the destination country.** The Sure Cross wireless products were certified for use in these countries using the antenna that ships with the product. When using other antennas, verify you are not exceeding the transmit power levels allowed by local governing agencies. This device has been designed to operate with the antennas listed on Banner Engineering's website and having a maximum gain of 9 dBm. Antennas not included in this list or having a gain greater than 9 dBm are strictly prohibited for use with this device. The required antenna impedance is 50 ohms. To reduce potential radio interference to other users, the antenna type and its gain should be so chosen such that the equivalent isotropically radiated power (EIRP) is not more than that permitted for successful communication. Consult with Banner Engineering Corp. if the destination country is not on this list.

Banner Engineering Corp. Limited Warranty

Banner Engineering Corp. warrants its products to be free from defects in material and workmanship for one year following the date of shipment. Banner Engineering Corp. will repair or replace, free of charge, any product of its manufacture which, at the time it is returned to the factory, is found to have been defective during the warranty period. This warranty does not cover damage or liability for misuse, abuse, or the improper application or installation of the Banner product.

THIS LIMITED WARRANTY IS EXCLUSIVE AND IN LIEU OF ALL OTHER WARRANTIES WHETHER EXPRESS OR IMPLIED (INCLUDING, WITHOUT LIMITATION, ANY WARRANTY OF MERCHANTABILITY OR FITNESS FOR A PARTICULAR PURPOSE), AND WHETHER ARISING UNDER COURSE OF PERFORMANCE, COURSE OF DEALING OR TRADE USAGE.

This Warranty is exclusive and limited to repair or, at the discretion of Banner Engineering Corp., replacement. **IN NO EVENT SHALL BANNER ENGINEERING CORP. BE LIABLE TO BUYER OR ANY OTHER PERSON OR ENTITY FOR ANY EXTRA COSTS, EXPENSES, LOSSES, LOSS OF PROFITS, OR ANY INCIDENTAL, CONSEQUENTIAL OR SPECIAL DAMAGES RESULTING FROM ANY PRODUCT DEFECT OR FROM THE USE OR INABILITY TO USE THE PRODUCT, WHETHER ARISING IN CONTRACT OR WARRANTY, STATUTE, TORT, STRICT LIABILITY, NEGLIGENCE, OR OTHERWISE.**

Banner Engineering Corp. reserves the right to change, modify or improve the design of the product without assuming any obligations or liabilities relating to any product previously manufactured by Banner Engineering Corp. Any misuse, abuse, or improper application or installation of this product or use of the product for personal protection applications when the product is identified as not intended for such purposes will void the product warranty. Any modifications to this product without prior express approval by Banner Engineering Corp will void the product warranties. All specifications published in this document are subject to change; Banner reserves the right to modify product specifications or update documentation at any time. Specifications and product information in English supersede that which is provided in any other language. For the most recent version of any documentation, refer to: www.bannerengineering.com.

For patent information, see www.bannerengineering.com/patents.

Notas Adicionales

Información México: La operación de este equipo está sujeta a las siguientes dos condiciones: 1) es posible que este equipo o dispositivo no cause interferencia perjudicial y 2) este equipo debe aceptar cualquier interferencia, incluyendo la que pueda causar su operación no deseada.

Banner es una marca registrada de Banner Engineering Corp. y podrán ser utilizadas de manera indistinta para referirse al fabricante. "Este equipo ha sido diseñado para operar con las antenas tipo Omnidireccional para una ganancia máxima de antena de 6 dBd y Yagi para una ganancia máxima de antena 10 dBd que en seguida se enlistan. También se incluyen aquellas con aprobación ATEX tipo Omnidireccional siempre que no excedan una ganancia máxima de antena de 6dBd. El uso con este equipo de antenas no incluidas en esta lista o que tengan una ganancia mayor que 6 dBd en tipo omnidireccional y 10 dBd en tipo Yagi, quedan prohibidas. La impedancia requerida de la antena es de 50 ohms."

Antenas SMA	Modelo	Antenas Tipo-N	Modelo
Antena, Omni 902-928 MHz, 2 dBd, junta de caucho, RP-SMA Macho	BWA-902-C	Antena, Omni 902-928 MHz, 6 dBd, fibra de vidrio, 1800mm, N Hembra	BWA-906-A
Antena, Omni 902-928 MHz, 5 dBd, junta de caucho, RP-SMA Macho	BWA-905-C	Antena, Yagi, 900 MHz, 10 dBd, N Hembra	BWA-9Y10-A

Mexican Importer

Banner Engineering de México, S. de R.L. de C.V.
David Alfaro Siqueiros 103 Piso 2 Valle oriente
San Pedro Garza Garcia Nuevo León, C. P. 66269
81 8363.2714