

1T8F_4.2U series

1W - Single Output DC-DC Converter - Fixed Input - Isolated & Unregulated

DC-DC Converter

1 Watt

- ⊕ Small footprint
- ⊕ Miniature SMD 8Pin package
- ⊕ High efficiency up to 75%
- ⊕ 4200VDC isolation
- ⊕ Temperature range: -40°C ~ +105°C
- ⊕ Industry standard pinout
- ⊕ Low coupling capacity
- ⊕ Internal SMD construction
- ⊕ Qualified for lead-free reflow solder process according to IPC/JEDEC J-STD-020D.1
- ⊕ Tape & reel package option

The 1T8F_4.2U series is specially designed for applications where a group of polar power supplies are isolated from the input power supply in a distributed power supply system on a circuit board.

These products apply to:

- 1) Where the voltage of the input power supply is fixed (voltage variation $\leq \pm 10\%$)
- 2) Where isolation is necessary between input and output (isolation voltage $\leq 4200\text{VDC}$)
- 3) Where the regulation of the output voltage and the output ripple noise are not demanding. Such as: digit circuit condition; normal low-frequency artificial circuit condition; relay drive circuit condition, etc.



Common specifications

Short circuit protection:	(automatic recovery) 0.5sec, max.
Temperature rise at full load:	25°C TYP (Ta= 25°C)
Cooling:	Free air convection
Operation temperature range:	-40°C~+105°C (see derating curve)
Storage temperature range:	-55°C ~+125°C
Lead-free reflow solder process:	IPC/JEDEC J-STD-020D.1
Reflow temperature:	245°C MAX, 1.5mm from case for 10 sec
Storage humidity range:	< 95%
Safety standard:	IEC60950-1
Vibration:	MIL-STD-810F
MTBF (MIL-HDBK-217F@25°C):	>8 Mhours
Base material:	Epoxy Resin [UL94-V0]
Weight:	1.52g
Dimensions:	0.5"x0.44"x0.27"

Input specifications

Item	Test condition	Min	Typ	Max	Units
Input filter	Capacitor				
Input voltage range				± 10	%
Input surge voltage	• 3.3V models • 5V models			5 9	VDC VDC
Input reflected ripple current*			20		mA pk-pk

* Measured with a simulated source inductance of 12 μ H and a source capacitor Cin (47 μ F, ESR<1.0 Ω at100kHz).

Isolation specifications

Item	Test condition	Min	Typ	Max	Units
Isolation voltage	Qualification: 60 sec. Production: 3 sec.	4200			VDC
Isolation resistance	Test at 500VDC	1000			M Ω
Isolation capacitance			25		pF

Model selection/example: 1T8F_0505S4.2U

1 = 1Watt; T8 = SMT8; F = Pinning; 5Vin; 5Vout; S = Single output;
4.2 = 4.2kVDC; U = Unregulated output

Output specifications

Item	Test condition	Min	Typ	Max	Units
Output voltage accuracy	See tolerance envelope curve				
Line regulation	For Vin change of 1%			± 1.2	%
Load regulation	10% to 100% load • 3.3VDC output • 5VDC output			± 15 ± 12	% %
Temperature drift	100% full load			± 0.03	%/°C
Ripple & Noise*	20MHz Bandwidth			150	mVp-p
Switching frequency	Full load, nominal input		50-80		KHz

EMC specifications

EMI	CE	EN55032	CLASS B
EMI	RE	EN55032	CLASS B
EMS	ESD	IEC/EN61000-4-2	perf. Criteria A
EMS	RS	IEC/EN61000-4-3	perf. Criteria A
EMS	EFT	IEC/EN61000-4-4	perf. Criteria A
EMS	Surge	IEC/EN61000-4-5	perf. Criteria A
EMS	CS	IEC/EN61000-4-6	perf. Criteria A
EMS	PFMF	IEC/EN61000-4-8	perf. Criteria A

* Input components (C1,D1) are used to help meet surge test requirement for the module. C1 and D1 recommended nichicon UHE and Littelfuse SMDJ series.

Note:

1. Operation under minimum load will not damage the converter; However, they may not meet all specification listed.
2. Max. Capacitive Load tested at input voltage range and full load.
3. All specifications measured at Ta = 25°C, humidity <75%, nominal input voltage and rated output load unless otherwise specified.
4. In this datasheet, all the test methods of indications are based on our corporate standards.
5. Operation under no-load conditions will not damage these devices, however they may not meet all listed specifications.
6. The 1T8F series of converters are not internally fused so to meet the requirements of UL; an anti-surge input line fuse should always be used with ratings as defined as follows: Input Voltage, 3.3V: 1.0A / Input Voltage, 5.0V: 1.0A All fuses should be UL recognized and rated to at least the maximum allowable DC input voltage.
7. It is not recommended to use water-washing process on SMT units.

1T8F_4.2U series

1W - Single Output DC-DC Converter - Fixed Input - Isolated & Unregulated

Part Number	Input Voltage [V]	Input Current [mA, typ.]	Output Voltage [VDC]	Output Current [mA]	Capacitive load [μ F, max.]	Efficiency [%, typ]
1T8F_0303S4.2U	3.3	421	3.3	303	220	72
1T8F_0305S4.2U	3.3	410	5	200	220	74
1T8F_0503S4.2U	5	278	3.3	303	220	72
1T8F_0505S4.2U	5	267	5	200	220	75

Typical characteristics

Temperature derating graph

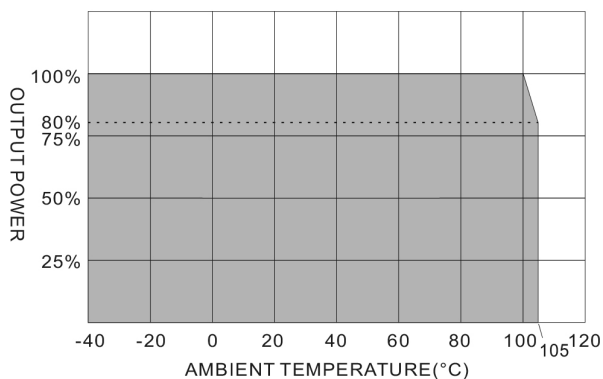

Test configurations

Input reflected ripple current test step

Input reflected ripple current is measured through a source inductor L_{in} (12 μ H) and a source capacitor C_{in} (47 μ H, ESR<1.0 Ω at 100kHz) at nominal input and full load.

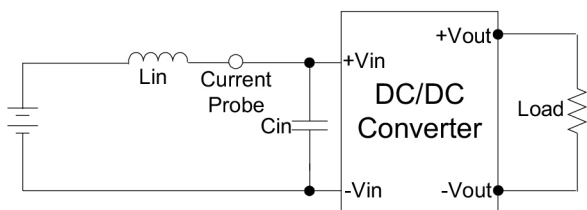

Output ripple & noise measurement test

Use a 10 μ F electrolytic capacitor and 0.1 μ F ceramic capacitor. The scope measurement is 0-20MHz.

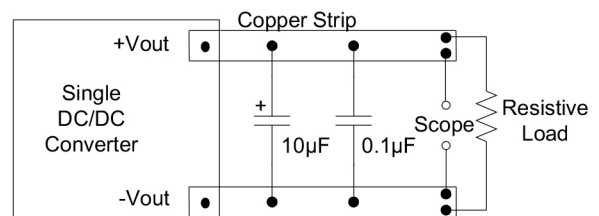

EFT & SURGE filter

Input components (C_1 , D_1) are used to help meet surge test requirements for the module.

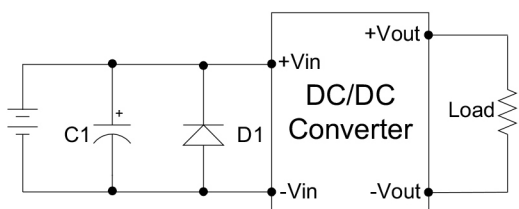

	C_1	D_1
1T8F_0303S4.2U	330 μ F/50V	SMDJ9.0A
1T8F_0305S4.2U	330 μ F/50V	SMDJ9.0A
1T8F_0503S4.2U	330 μ F/50V	SMDJ9.0A
1T8F_0505S4.2U	330 μ F/50V	SMDJ9.0A

EMI filter

Input filter components (C_1 , L) are used to help meet conducted emissions requirement for the module. These components should be mounted as close as possible to the module; and all leads should be minimized to decrease radiated noise.

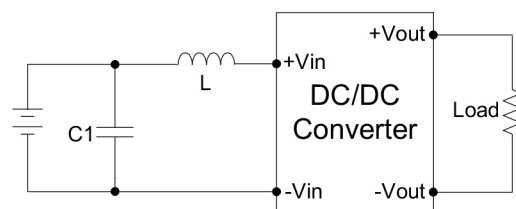

	C_1	L
1T8F_0303S4.2U	1206,22 μ F/10V	6.8 μ H
1T8F_0305S4.2U	1206,22 μ F/10V	6.8 μ H
1T8F_0503S4.2U	1206,22 μ F/10V	6.8 μ H
1T8F_0505S4.2U	1206,22 μ F/10V	6.8 μ H

1T8F_4.2U series

1W - Single Output DC-DC Converter - Fixed Input - Isolated & Unregulated

Tolerance envelope curve

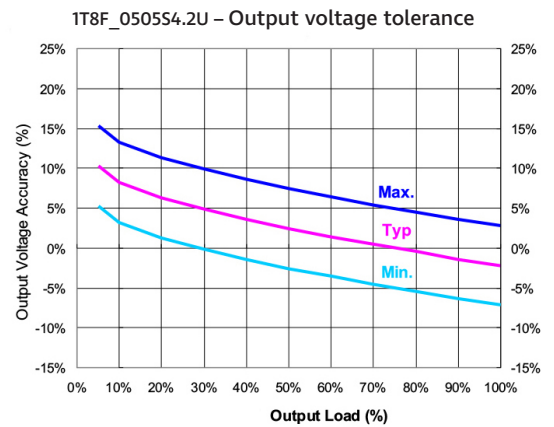
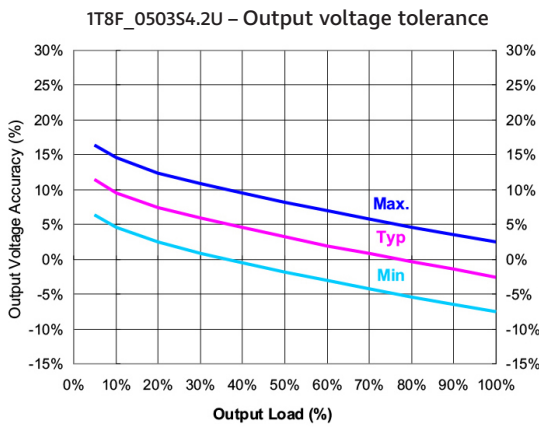
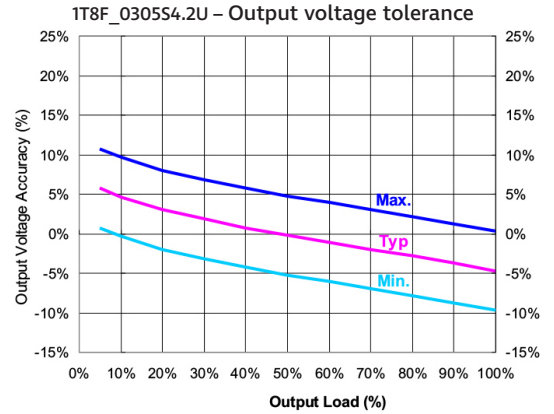
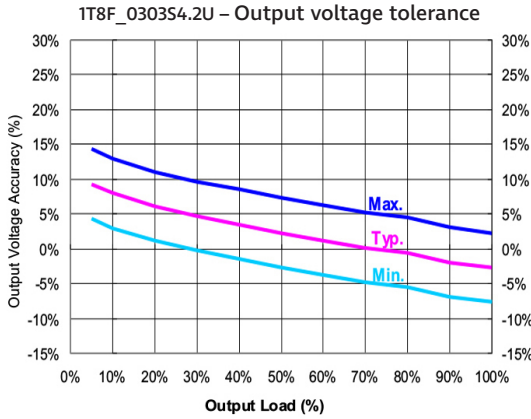

Efficiency

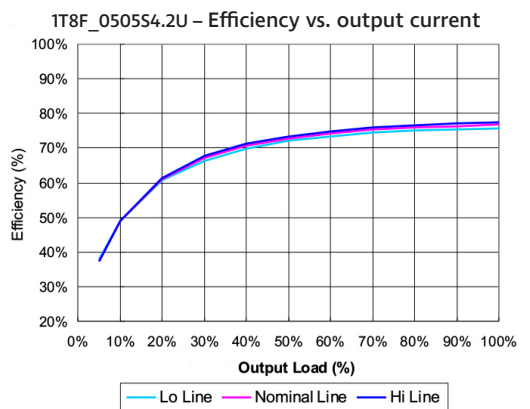
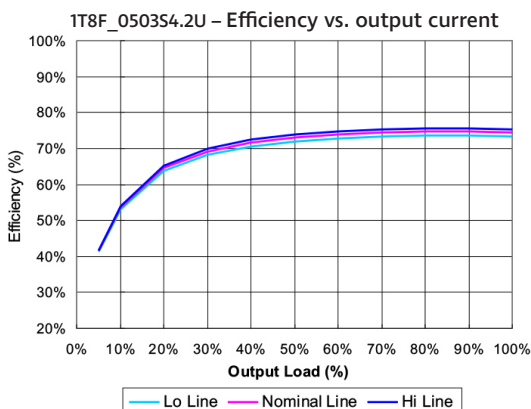
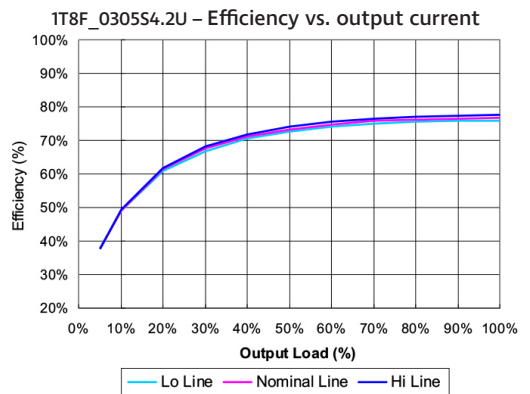
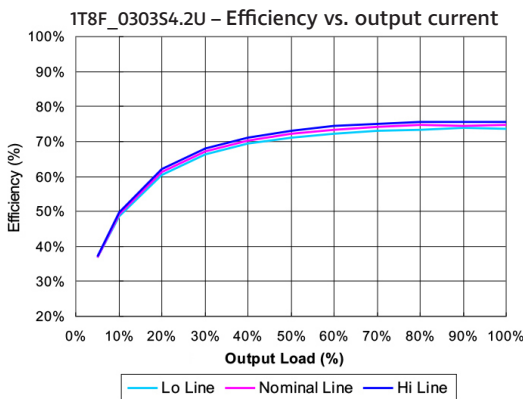

1T8F_4.2U series

1W - Single Output DC-DC Converter - Fixed Input - Isolated & Unregulated

Mechanical dimensions

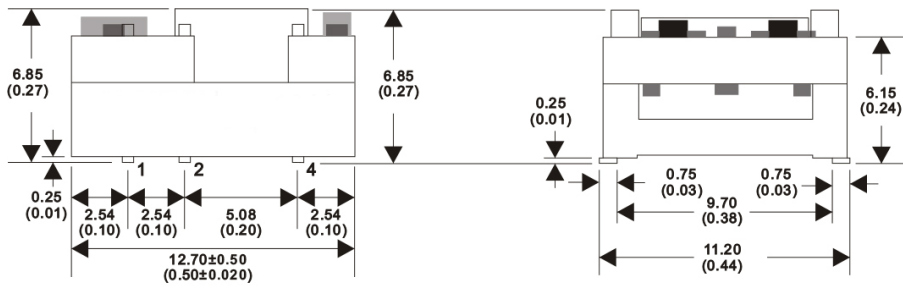

PIN	Single
1	-Vin
2	+Vin
4	-Vout
5	+Vout
8	NC

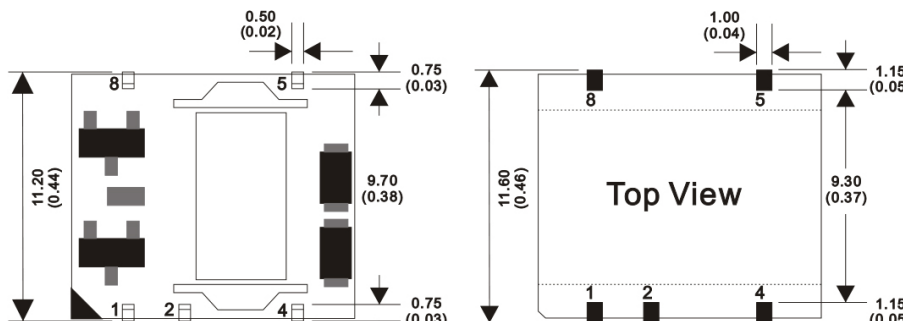

Note:
Unit: mm[inch]
General tolerances: ±0.25mm[±0.010inch]

Tube outline dimensions

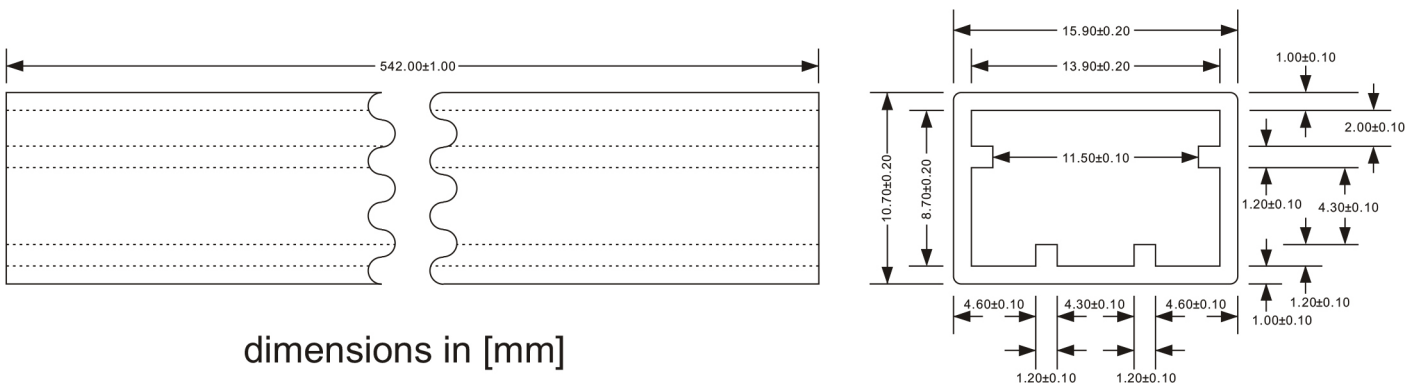

dimensions in [mm]

1T8F_4.2U series

1W - Single Output DC-DC Converter - Fixed Input - Isolated & Unregulated

Packing informations

Optional packing - Tape & Reel

- Specifications shall conform with current EIA-481 standard
- 1 Reel contains 500 converters
- Use appendix <<-R>> on order code

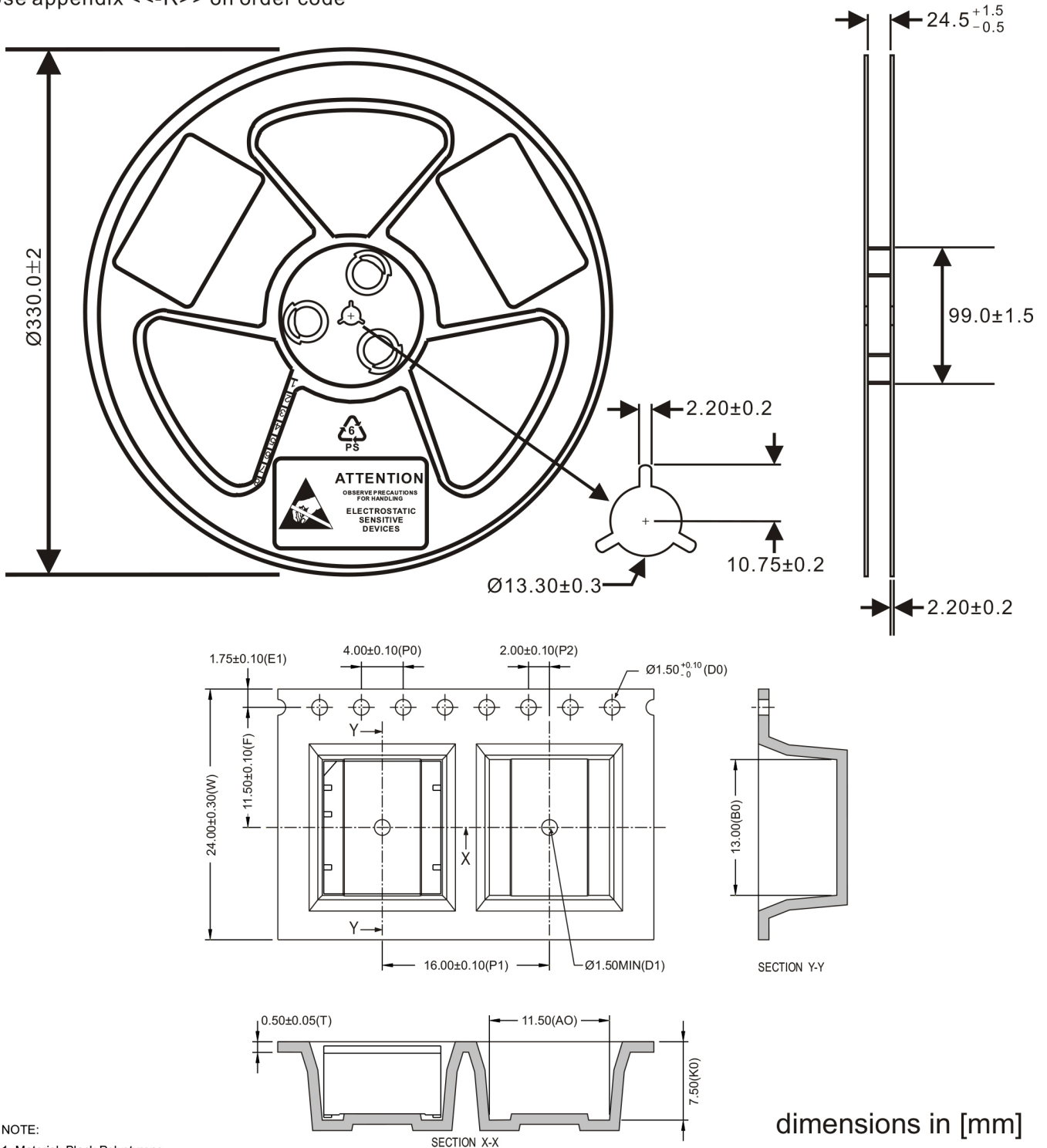

NOTE:

1. Material: Black Polystyrene.
2. Camber not to exceed 1mm in 100mm.
3. 10 sprocket hole pitch cumulative tolerance ± 0.2
4. A0 and B0 measured on a plane 0.3mm above the bottom of the pocket.
5. K0 measured from a plane on the inside bottom of the pocket to the top surface of the carrier.
6. Pocket position relative to sprocket hole measured as true position of pocket, not pocket hole.

Carrier Length: 26M / 22" reel, Q'ty= 500 pcs/13"reel

ITEM	W	A0	B0	K0	P1	F	E1	D0	P0	P2	T	D1
DIM	24.0 ^{+0.30} _{-0.30}	11.5 ^{+0.10} _{-0.10}	13.0 ^{+0.10} _{-0.10}	7.50 ^{+0.15} _{-0.15}	16.0 ^{+0.10} _{-0.10}	11.50 ^{+0.10} _{-0.10}	1.75 ^{+0.10} _{-0.10}	1.50 ^{+0.10} _{-0.00}	4.00 ^{+0.10} _{-0.10}	2.00 ^{+0.10} _{-0.10}	0.50 ^{+0.05} _{-0.05}	1.50MIN

dimensions in [mm]