

回路番号1用マーク  
CKT. NO.1 MARK

注記 NOTES  
 1. 接点部までの嵌合長さ。  
LENGTH TO CONTACT POINT.  
 2. 使用材料 MATERIAL  
 ハウジング : 46ナイロン (耐熱性), UL94V-0  
 HOUSING : 46NYLON, UL94V-0  
 アクチュエータ : PPS, UL94V-0  
 ACTUATOR : PPS, UL94V-0  
 ターミナル : リン青銅, 半田メッキ (t=0.32)  
 TERMINAL : PHOS-BRO., TIN-LEAD PLATED (t=0.32)  
 金具 : 銅合金, 半田メッキ (t=0.25)  
 FITTING NAIL : COPPER ALLOY, TIN-LEAD PLATED (t=0.25)

3. パターンはくり止め用金具  
FITTING NAIL FOR PREVENTION OF PEELING OF P.C.B.PATTERN.  
 4. エンボステープ梱包時は、アクチュエータがロックした状態とする。  
IN THE PACKAGE, ACTUATOR OF PART NO. 52207-\*\*17 SHOULD BE LOCKED.  
 5. ケーブル挿入深さ  
INSERTION DEPTH OF CABLE.  
 6. パターン書き込み禁止エリア。  
NO FOOT PRINT AREA.

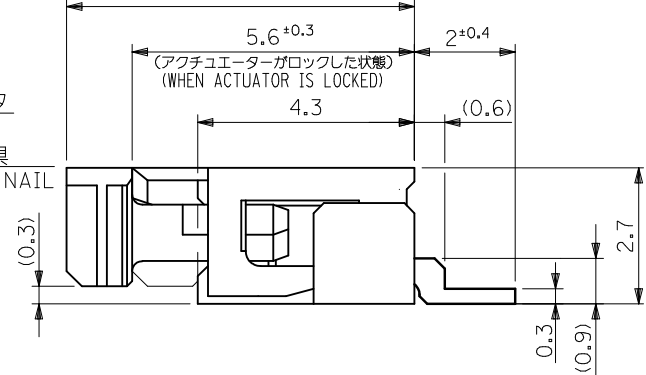

34.7	31.2	29	52207-3090	30
32.7	29.2	27	-2890	28
29.7	26.2	24	-2590	25
28.7	25.2	23	-2490	24
26.7	23.2	21	-2290	22
21.7	18.2	16	-1790	17
19.7	16.2	14	-1590	15
18.7	15.2	13	-1490	14
15.7	12.2	10	-1190	11
14.7	11.2	9	-1090	10
13.7	10.2	8	-0990	9
12.7	9.2	7	-0890	8
11.7	8.2	6	52207-0790	7

REVISED EC NO: J2016-0429 DRWN: SANUMA 2015/10/26 CHKD: TAKAHASHI 2015/10/29 APPR: YNOGAWA 2015/11/13	GENERAL TOLERANCES (UNLESS SPECIFIED)		DIMENSION STYLE MM ONLY		SCALE ---	DESIGN UNITS METRIC	THIRD ANGLE PROJECTION
	0.25 UNDER	UNDER	±0.03	DRAWN BY MTAKAHASHI04	DATE 2013/07/24	TITLE 1.0 FPC CONN. ZIF SMT (SHEET 1 OF 2)	
	0.25 OVER	0.5 UNDER	±0.05	CHECKED BY KTAKAHASHI	DATE 2013/07/24	DOCUMENT NO. SD-52207-071	
	0.5 OVER	1.0 UNDER	±0.1	APPROVED BY YNOGAWA	DATE 2013/10/07		
1.0 OVER	10 UNDER	±0.2	MATERIAL NO.		SHEET NO.		
10 OVER	30 UNDER	±0.25	SEE CHART		1 OF 2		
30 OVER		±0.3	SIZE A3		THIS DRAWING CONTAINS INFORMATION THAT IS PROPRIETARY TO MOLEX INCORPORATED AND SHOULD NOT BE USED WITHOUT WRITTEN PERMISSION		
	ANGULAR ±3 °		DRAFT WHERE APPLICABLE MUST REMAIN WITHIN DIMENSIONS				

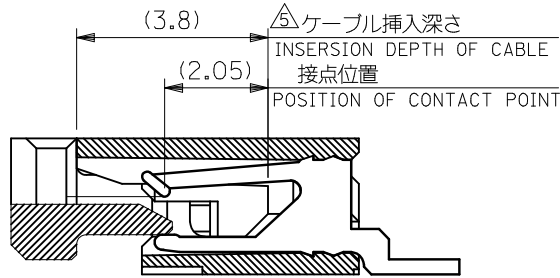

断面D-D  
SECT.D-D

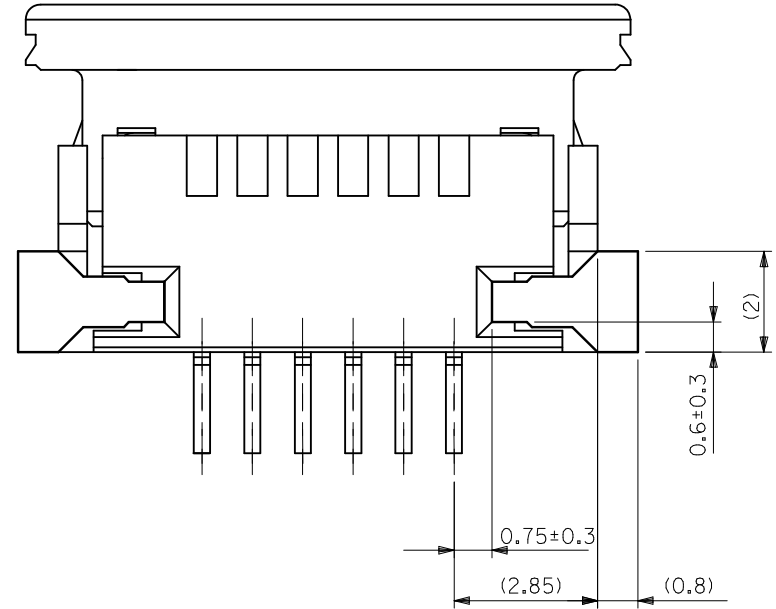

下面図  
BOTTOM VIEW

REVISED EC NO: J2016-0429 DRWN: SANUMA 2015/10/26 CHKD: TAKAHASHI 2015/10/29 APPR: YNOGAWA 2015/11/13	GENERAL TOLERANCES (UNLESS SPECIFIED)			DIMENSION STYLE MM ONLY		SCALE ---	DESIGN UNITS METRIC	THIRD ANGLE PROJECTION	
	0.25 UNDER	UNDER	±0.03	DRAWN BY	DATE	TITLE			
	0.25 OVER	0.5 UNDER	±0.05	MTAKAHASHI04	2013/07/24	1.0 FPC CONN ZIF SMT			
	0.5 OVER	1.0 UNDER	±0.1	CHECKED BY	DATE	SHEET 2 OF 2			
	1.0 OVER	10 UNDER	±0.2	KTAKAHASHI	2013/07/24	<b>molex</b> DOCUMENT NO. SD-52207-071 SHEET NO. 2 OF 2			
10 OVER	30 UNDER	±0.25	APPROVED BY	DATE					
30 OVER		±0.3	YNOGAWA	2013/10/07	SEE SHEET 1 OF 2				
ANGULAR	±3 °		MATERIAL NO.						
DRAFT WHERE APPLICABLE MUST REMAIN WITHIN DIMENSIONS				SIZE A3	THIS DRAWING CONTAINS INFORMATION THAT IS PROPRIETARY TO MOLEX INCORPORATED AND SHOULD NOT BE USED WITHOUT WRITTEN PERMISSION				

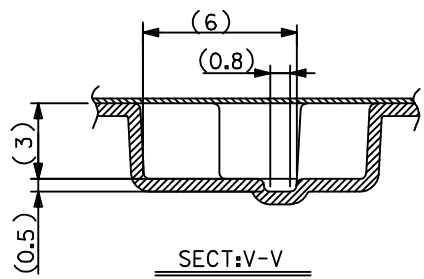
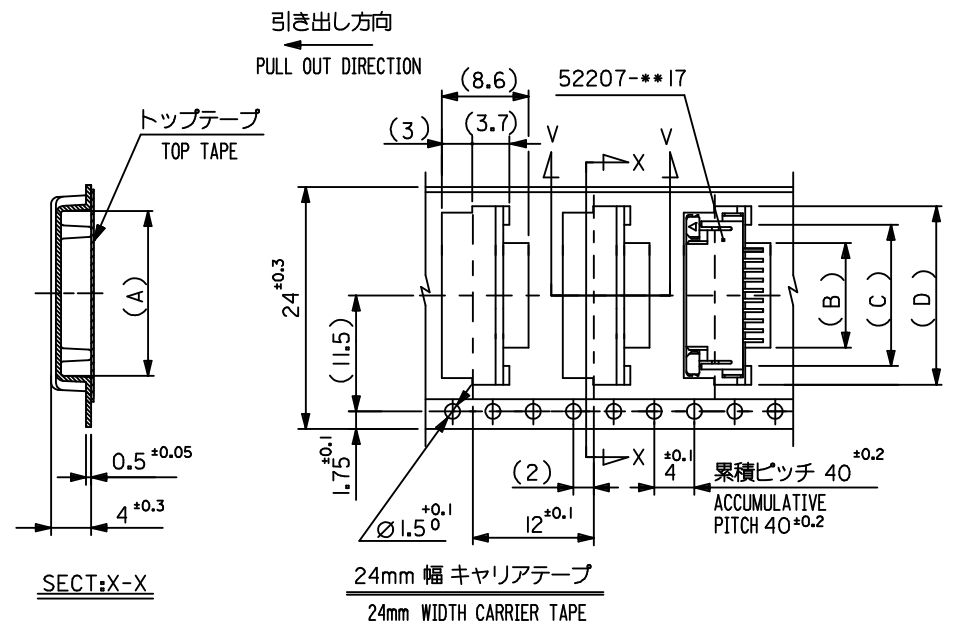

24	25.5	18.5	15	11.7	17.3	52207-1190	11
		17.5	14	10.7	16.3	52207-1090	10
		16.5	13	9.7	15.3	52207-0990	9
		15.5	12	8.7	14.3	52207-0890	8
		14.5	11	7.7	13.3	52207-0790	7
キャリアテープ幅 CARRIER TAPE WIDTH	E	(D)	(C)	(B)	(A)	EMBOSSED PACKAGE ORDER NO.	極致 CKT.

REVISED EC NO: J2016-0429 DRWN: SANUMA 2015/10/26 CHKD: TAKAHASHI 2015/10/29 APPR: YNOGAWA 2015/11/13	GENERAL TOLERANCES (UNLESS SPECIFIED)		DIMENSION STYLE MM ONLY		SCALE ---	DESIGN UNITS METRIC	THIRD ANGLE PROJECTION
	0.25 UNDER	UNDER	±0.03	DRAWN BY	DATE	TITLE	
	0.25 OVER	0.5 UNDER	±0.05	MTAKAHASHI	04 2013/07/24	EMBOSSED TAPE PACKAGE FOR 52207-***17 SHEET 1 OF 3	
	0.5 OVER	1.0 UNDER	±0.1	CHECKED BY	DATE	molex	
	1.0 OVER	10 UNDER	±0.2	KTAKAHASHI	2013/07/24	DOCUMENT NO.	SHEET NO.
10 OVER	30 UNDER	±0.25	APPROVED BY	DATE	SD-52207-072	1 OF 3	
30 OVER		±0.3	YNOGAWA	2013/10/07	SEE CHART		
ANGULAR	±3 °		MATERIAL NO.	THIS DRAWING CONTAINS INFORMATION THAT IS PROPRIETARY TO MOLEX INCORPORATED AND SHOULD NOT BE USED WITHOUT WRITTEN PERMISSION			
DRAFT WHERE APPLICABLE MUST REMAIN WITHIN DIMENSIONS			SIZE A3				

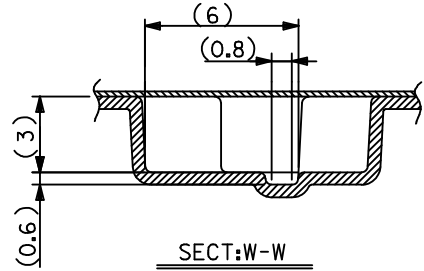
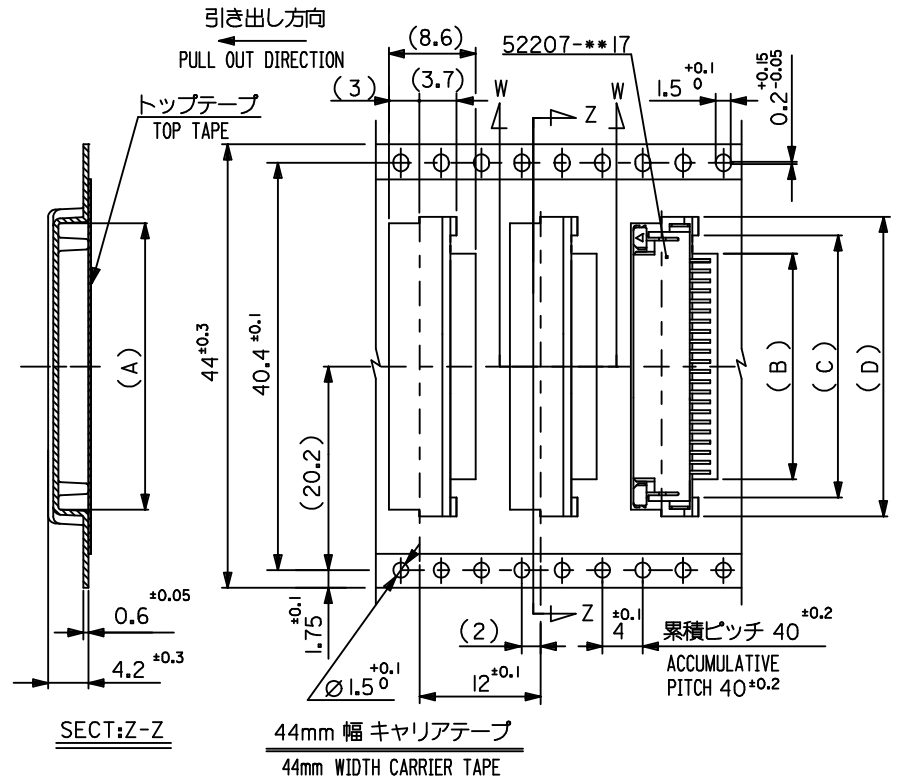
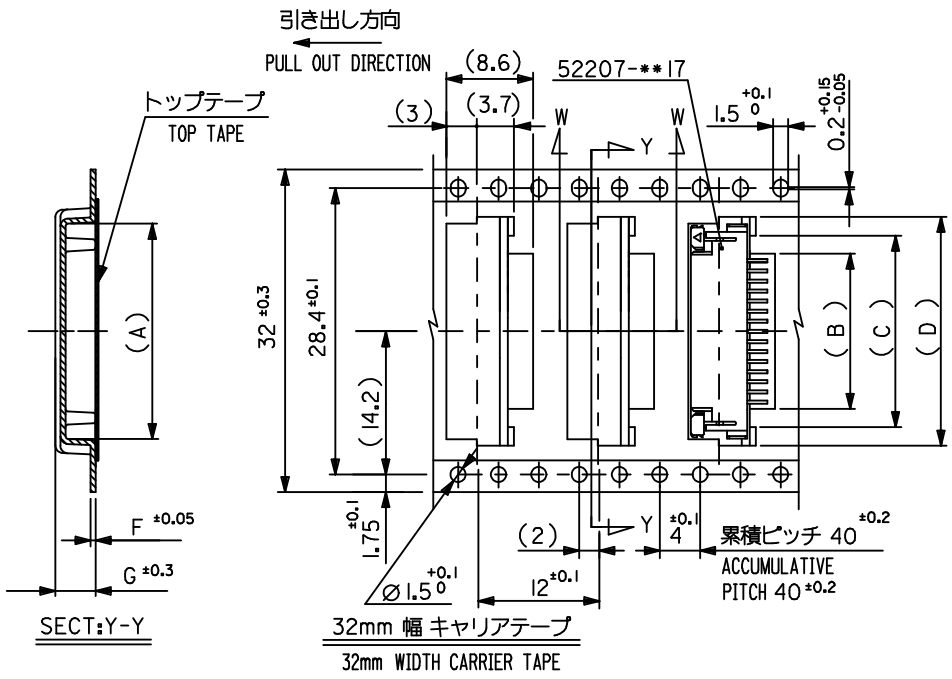

32	33.5	4.2	0.6	22.5	19	15.7	21.35	52207-1590	15
		4.2	0.6	21.5	18	14.7	20.35	52207-1490	14
キャリアテープ幅 CARRIER TAPE WIDTH	E	(G)	(F)	(D)	(C)	(B)	(A)	EMBOSSED PACKAGE ORDER NO.	極数 CKT.

44	45.5	32.5	29	25.7	31.35	52207-2590	25
		31.5	28	24.7	30.35	52207-2490	24
		29.5	26	22.7	28.35	52207-2290	22
		24.5	21	17.7	23.35	52207-1790	17
キャリアテープ幅 CARRIER TAPE WIDTH	E	(D)	(C)	(B)	(A)	EMBOSSED PACKAGE ORDER NO.	極数 CKT.

REVISED EC NO: J2016-0429 DRWN:NASANUMA 2015/10/26 CHKD:KAKAHASHI 2015/10/29 APPR:YNOGAWA 2015/11/13	GENERAL TOLERANCES (UNLESS SPECIFIED)		DIMENSION STYLE MM ONLY		SCALE ---		DESIGN UNITS METRIC		THIRD ANGLE PROJECTION	
	0.25 UNDER UNDER ±0.03		DRAWN BY DATE MTAKAHASHI 104 2013/07/24		TITLE EMBOSSED TAPE PACKAGE FOR 52207-**17 SHEET 2 OF 3				SHEET NO. 2 OF 3	
	0.25 OVER 0.5 UNDER ±0.05		CHECKED BY DATE KTAKAHASHI 2013/07/24		APPROVED BY DATE YNOGAWA 2013/10/07					
	0.5 OVER 1.0 UNDER ±0.1		10 OVER 10 UNDER ±0.2		MATERIAL NO.		DOCUMENT NO. SD-52207-072		SEE CHART	
10 OVER 30 UNDER ±0.25		30 OVER ±0.3		SIZE A3		THIS DRAWING CONTAINS INFORMATION THAT IS PROPRIETARY TO MOLEX INCORPORATED AND SHOULD NOT BE USED WITHOUT WRITTEN PERMISSION				
ANGULAR ±3 °		DRAFT WHERE APPLICABLE MUST REMAIN WITHIN DIMENSIONS								

引き出し方向  
PULL OUT DIRECTION

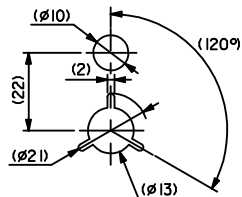
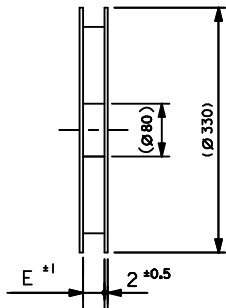
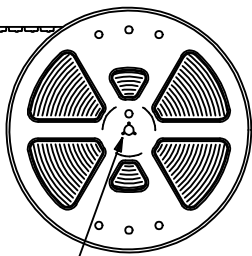

DETAIL "F"

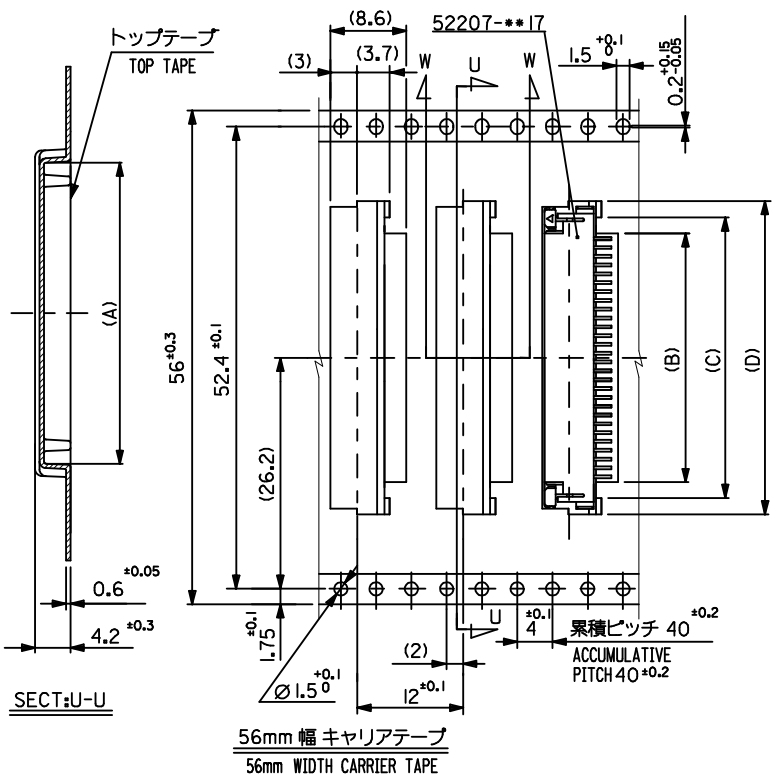

注記

- 製品番号 52207-\*\*\*17 の梱包状態はアクチュエータがロックした状態とする。  
詳細寸法については図面 SD-52207-071 を参照下さい。  
IN THE PACKAGE, ACTUATOR OF PART NO.52207-\*\*\*17 SHOULD BE LOCKED  
RE DETAILED DIMENSIONS, SEE SD-52207-071
- 梱包数量：1000個/リール  
NUMBER OF CONNECTORS : 1000PCS/REEL
- リードテープ長さ(LEAD TAPE LENGTH)

トップテープ TOP TAPE      トップテープ TOP TAPE  
リーダー部 LEADER PART      未接着部 NON-BONDED PART

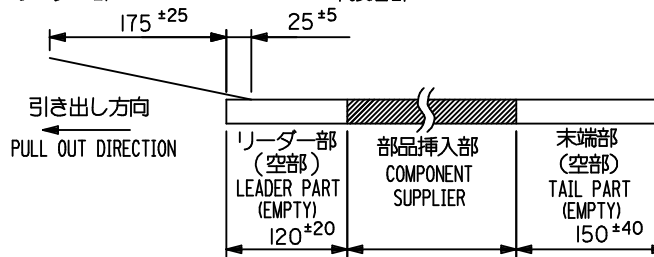

- トップテープの剥離強度：(剥離方向は下図参照)  
60gf MAX. 尚、本規格値は、出荷時に適用。(但し、輸送時に剥離が発生しない事。)  
PEELING OFF FORCE OF TOP TAPE : 60gf MAX. (PEELING DIRECTION AS SHOWN IN FOLLOWING FIG.)  
THIS REQUIREMENT SHOULD BE APPLIED AT SHIPMENT. (PEEL OFF SHOULD NOT BE ALLOWED, DURING TRANSPORTATION.)

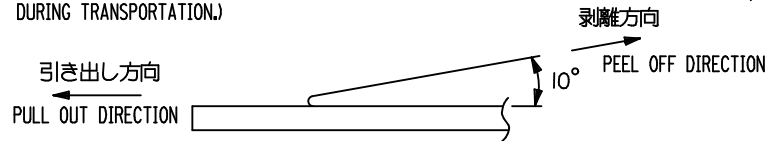

- 材料 (MATERIAL)  
キャリアテープ (CARRIER TAPE) : ポリプロピレン (POLYPROPYLENE)  
トップテープ (TOPTAPE) : PET, PE, PEF  
リール (REEL) : ポリスチレン (PS) <リサイクル材を含む>  
POLYSTYREN (PS) <RECYCLE MATERIAL CONTAINED>

56	57.5	37.5	34	30.7	36.35	52207-3090	30
		35.5	32	28.7	34.35	52207-2890	28
キャリアテープ幅 CARRIER TAPE WIDTH	E	(D)	(C)	(B)	(A)	EMBOSSED PACKAGE ORDER NO.	極致 CKT.

REVISED EC NO: J2016-0429 DRWN:NASANUMA 2015/10/26 CHKD:KAKAHASHI 2015/10/29 APPR:YNOGAWA 2015/11/13	GENERAL TOLERANCES (UNLESS SPECIFIED)		DIMENSION STYLE MM ONLY		SCALE ---	DESIGN UNITS METRIC	THIRD ANGLE PROJECTION
	0.25 UNDER	UNDER	±0.03	DRAWN BY MTAKAHASHI	DATE 104 2013/07/24	TITLE EMBOSSED TAPE PACKAGE FOR 52207-***17 SHEET 3 OF 3	
	0.25 OVER	0.5 UNDER	±0.05	CHECKED BY KTAKAHASHI	DATE 2013/07/24		
	0.5 OVER	1.0 UNDER	±0.1	APPROVED BY YNOGAWA	DATE 2013/10/07		
1.0 OVER	10 UNDER	±0.2	MATERIAL NO.		DOCUMENT NO.	SHEET NO.	
10 OVER	30 UNDER	±0.25	SEE CHART		SD-52207-072	3 OF 3	
30 OVER		±0.3	THIS DRAWING CONTAINS INFORMATION THAT IS PROPRIETARY TO MOLEX INCORPORATED AND SHOULD NOT BE USED WITHOUT WRITTEN PERMISSION				
ANGULAR	±3 °						
DRAFT WHERE APPLICABLE MUST REMAIN WITHIN DIMENSIONS							