

DC MOTOR 5 click schematic v100

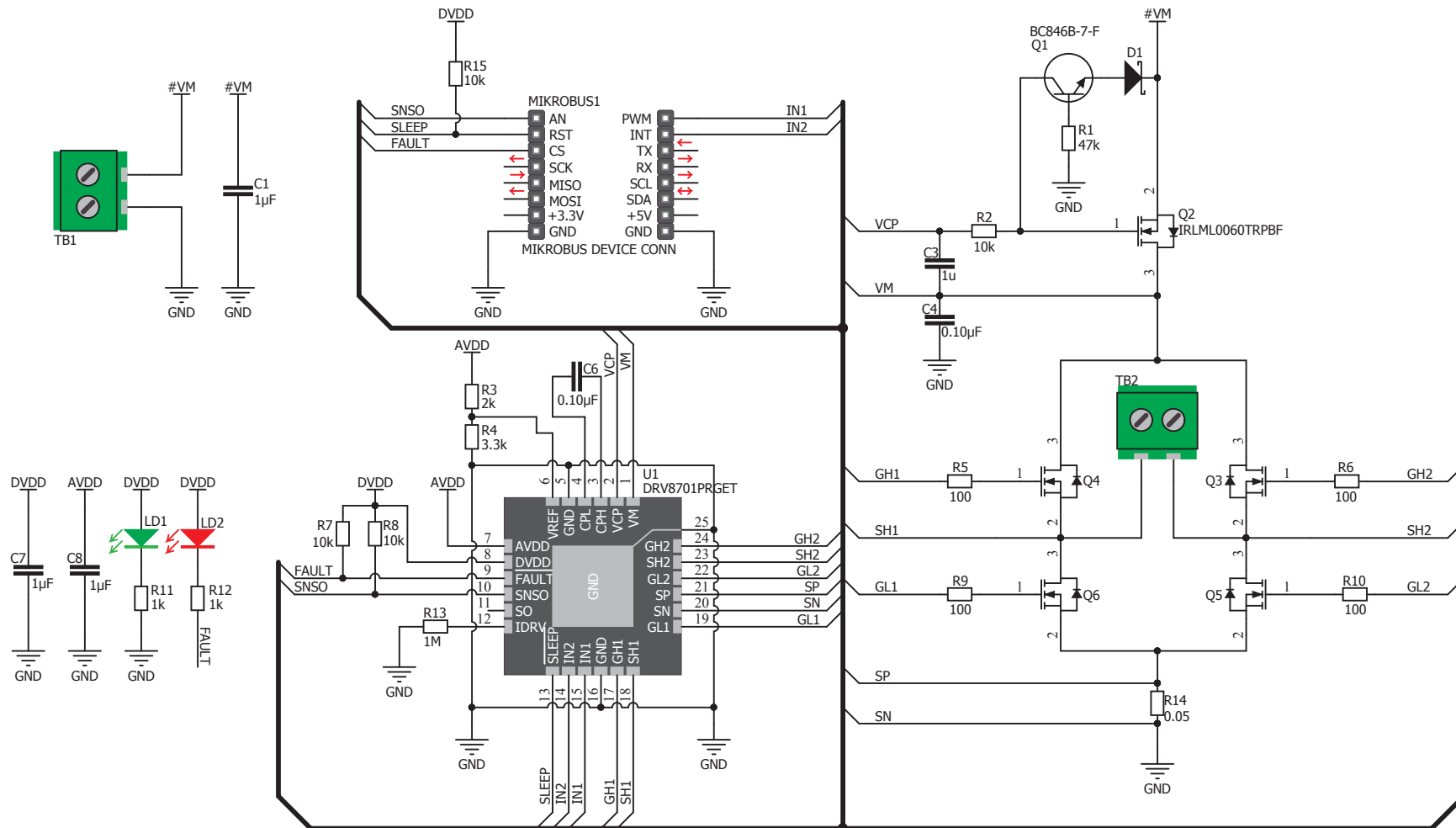

www.mikroe.com