

Data sheet | Item number: 890-606

T-distribution connector; 3-pole; Cod. A; 1 input; 2 outputs; 2 locking levers;  
black

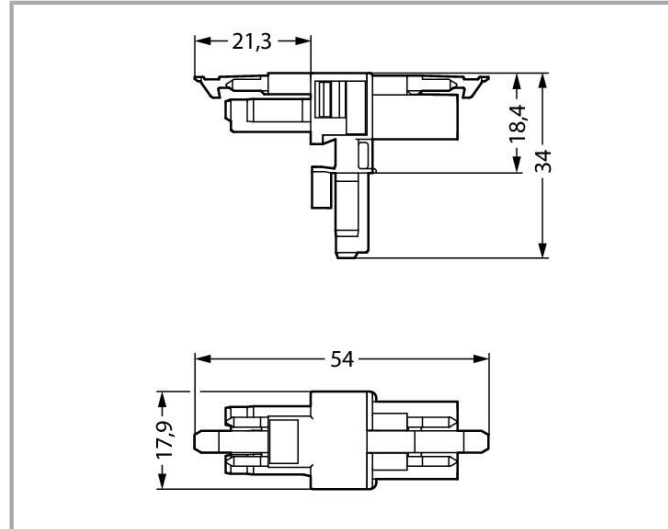

[www.wago.com/890-606](http://www.wago.com/890-606)



## Item description

### Distribution connector *WINSTA*® MINI 3-pole

The *WINSTA*® MINI distribution connector A coding supports fast, reliable installation. WAGO pluggable installation connectors are used when requirements repeat or are planned on a specified grid, for example for installing grid lighting or flush-mount lighting. For greater security in electrical installations, the pluggable installation connector is equipped with mechanical protection against mismatching. Thanks to the color coding and mechanical A coding of *WINSTA*® MINI pluggable installation connectors, you can clearly distinguish different circuits. *WINSTA*® MINI satisfies the demand for miniaturisation. Our smallest pluggable connection system is very good for lights, for instance, since due to LED technology, these offer significantly less space for the connection technology.

Subject to changes. Please also observe the further product documentation!

WAGO GmbH & Co. KG  
Hansastr. 27  
32423 Minden  
Phone: +49571 887-0 | Fax: +49571 887-169  
Email: [info.de@wago.com](mailto:info.de@wago.com) | Web: [www.wago.com](http://www.wago.com)

Do you have any questions about our products?  
We are always happy to take your call at +49 (571) 887-44222.



## Lower costs through fast commissioning and elimination of service expenses – solutions from WINSTA® MINI

WINSTA® is the pluggable connection system that is perfectly tailored to the strict requirements of electrical installation. It offers error-free installation of cables and components, quickly and reliably. Enjoy the benefits of the pluggable version of our maintenance-free spring pressure connection technology too! Plan your installation with WINSTA® MINI pluggable installation connectors with marking from WAGO.

- effective protection against mismatching
- consistent IP40 protection
- with A coding for use in a large number of general mains applications
- custom-engineered solutions
- quick replacement of defective units during ongoing operation

### Data

#### Electrical data

#### Ratings per IEC/EN

Ratings per	IEC/EN 60664-1
Nominal voltage (III/3)	250 V
Rated impulse voltage (III/3)	4 kV
Rated current	16 A
Legend (ratings)	(III / 3) ≙ Overvoltage category III / Pollution degree 3

#### Ratings per UL 1977

Note for the US market	Some versions may also be used for current interruption in accordance with the UL certificate in select applications with currents below 5 A and voltages up to 600 V. For further information, please contact your local sales office.
Rated voltage (UL 1977)	600 V
Rated current UL 1977	14 A

### General

Note on contact resistance	approx. 1 mΩ of contact resistance approx. 0.25 mΩ contact transition plug/socket
----------------------------	--

### Connection data

Total number of potentials	3
----------------------------	---

Subject to changes. Please also observe the further product documentation!



PE function	Preceding PE contact
-------------	----------------------

## Connection 1

Pole number	3
-------------	---

## Physical data

Pin spacing	4.4 mm / 0.173 inches
Width	17.9 mm / 0.705 inches
Height	34 mm / 1.339 inches
Depth	54 mm / 2.122 inches

## Mechanical Data

Application	General mains applications
Coding	A
Variable coding	No
Marking	L $\perp$ N
Potential marking	L $\perp$ N
Mating force of a plug-in connection	approx. 20 ... 70 N (depending on pole number)
Retention force of a plug-in connection	When locked: > 80 N
Unmating force of a plug-in connection	Unlocked: approx. 20 ... 70 N (depending on pole number)
Number of mating cycles	200, without resistive load
Type of distribution box	T-distribution connector
Protection type	IP20; IP40 when mated

## Plug-in connection

Contact type (pluggable connector)	Socket/plug
Mismating protection	Yes
Note on mismating protection	All <i>WINSTA</i> <sup>®</sup> components are 100% protected against mismating when: a.) plugging different numbers of poles b.) plugging while rotated 180 c.) plugging while laterally staggered d.) plugging one pole
Locking lever	yes
Locking of plug-in connection	locking lever
Note on locking system	All connectors for mounted installations (snap-in versions for lighting fixtures or devices, all types of PCB and distribution

Subject to changes. Please also observe the further product documentation!



connectors) are factory-equipped with locking levers to ensure plugs and sockets are securely locked. Additional locking levers are only required for flying leads (plug/socket).

## Material Data

Note (material data)

Information on material specifications can be found here

Color	black
Insulation material	Polyamide (PA66)
Flammability class per UL94	V0
Contact material	Copper or copper alloy; surface-treated
Contact plating	Tin
Fire load	0.16 MJ
Weight	8 g

## Environmental requirements

Processing temperature	-5 ... +40 °C
Continuous operating temperature	-35 ... +85 °C
Note on continuous operating temperature	Insulating parts for temperatures ≤ 105 °C

## Commercial data

Product Group	20 (Winsta)
eCl@ss 10.0	27-44-06-03
eCl@ss 9.0	27-44-06-03
ETIM 8.0	EC002567
ETIM 7.0	EC002567
PU (SPU)	25 pcs
Packaging type	box
Country of origin	DE
GTIN	4045454490485
Customs tariff number	85366990990



## Environmental Product Compliance

RoHS Compliance Status	Compliant, No Exemption
------------------------	-------------------------



Subject to changes. Please also observe the further product documentation!

## Approvals / Certificates



### General approvals

Logo	Approval	Additional Approval Text	Certificate name
	CCA DEKRA Certification B.V.	EN 61535	71- 123231
	CCA DEKRA Certification B.V.	IEC 61535	NL-85020
	cURus Underwriters Laboratories Inc.	UL 1977	E45171

### Declarations of conformity and manufacturer's declarations

Logo	Approval	Additional Approval Text	Certificate name
	EU-Declaration of Conformity WAGO GmbH & Co. KG	-	-
	UK-Declaration of Conformity WAGO GmbH & Co. KG	-	-

### Approvals for marine applications







Logo	Approval	Additional Approval Text	Certificate name
	ABS American Bureau of Shipping	Steel Vessel Rules	19- HG1869855- PDA
	DNV GL Det Norske Veritas, Germanischer Lloyd	-	TAE00001Z6
	LR Lloyds Register	EN 61535	08/20047 (E2)

Subject to changes. Please also observe the further product documentation!

WAGO GmbH & Co. KG  
Hansastr. 27  
32423 Minden  
Phone: +49571 887-0 | Fax: +49571 887-169  
Email: [info.de@wago.com](mailto:info.de@wago.com) | Web: [www.wago.com](http://www.wago.com)

Do you have any questions about our products?  
We are always happy to take your call at +49 (571) 887-44222.

## Counterpart

	<b>Item no.890-103</b> Socket; with strain relief housing; 3-pole; Cod. A; 1,50 mm <sup>2</sup> ; black	<a href="http://www.wago.com/890-103">www.wago.com/890-103</a>
	<b>Item no.890-113</b> Plug; with strain relief housing; 3-pole; 1,50 mm <sup>2</sup> ; black	<a href="http://www.wago.com/890-113">www.wago.com/890-113</a>
	<b>Item no.890-203</b> Socket; 3-pole; Cod. A; 1,50 mm <sup>2</sup> ; black	<a href="http://www.wago.com/890-203">www.wago.com/890-203</a>
	<b>Item no.891-8993/105-101</b> pre-assembled connecting cable; Eca; Socket/open-ended; 3-pole; Cod. A; 1 m; 1,00 mm <sup>2</sup> ; black	<a href="http://www.wago.com/891-8993/105-101">www.wago.com/891-8993/105-101</a>
	<b>Item no.891-8993/005-101</b> pre-assembled interconnecting cable; Eca; Socket/plug; 3-pole; Cod. A; 1 m; 1,00 mm <sup>2</sup> ; black	<a href="http://www.wago.com/891-8993/005-101">www.wago.com/891-8993/005-101</a>
	<b>Item no.890-213</b> Plug; 3-pole; Cod. A; 1,50 mm <sup>2</sup> ; black	<a href="http://www.wago.com/890-213">www.wago.com/890-213</a>
	<b>Item no.891-8993/205-101</b> pre-assembled connecting cable; Eca; Plug/open-ended; 3-pole; Cod. A; 1 m; 1,00 mm <sup>2</sup> ; black	<a href="http://www.wago.com/891-8993/205-101">www.wago.com/891-8993/205-101</a>

## Downloads

### Documentation

#### Bid Text

890-606 X81 - Datei	2019 Feb 19	xml 2.8 kB	Download
890-606 doc - Datei	2018 Nov 30	doc 23.0 kB	Download

### CAD/CAE-Data

#### CAD data

2D/3D Models 890-606	URL	Download
----------------------	-----	----------

#### CAE data

EPLAN Data Portal 890-606	URL	Download
---------------------------	-----	----------

WSCAD Universe 890-606	URL	Download
------------------------	-----	----------

Subject to changes. Please also observe the further product documentation!

WAGO GmbH & Co. KG  
Hansastr. 27  
32423 Minden  
Phone: +49571 887-0 | Fax: +49571 887-169  
Email: [info.de@wago.com](mailto:info.de@wago.com) | Web: [www.wago.com](http://www.wago.com)

Do you have any questions about our products?  
We are always happy to take your call at +49 (571) 887-44222.

## Environmental Product Compliance

### Compliance Search

Environmental Product Compliance 890-606

[URL](#)

[Download](#)

T-distribution connector; 3-pole; Cod. A; 1 input; 2 outputs; 2 locking levers; black

## Installation Notes

### Installation

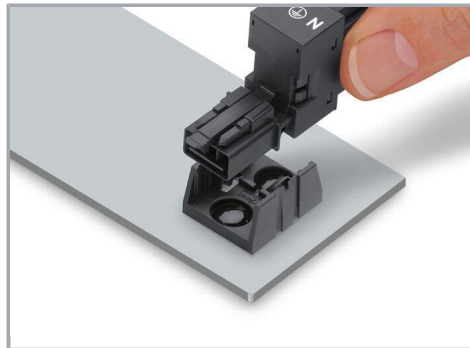

Secure the mounting plate via pins.

## Product family

**WINSTA® MINI**

[Show all products from the family](#)

Subject to changes. Please also observe the further product documentation!

WAGO GmbH & Co. KG

Hansastr. 27

32423 Minden

Phone: +49571 887-0 | Fax: +49571 887-169

Email: [info.de@wago.com](mailto:info.de@wago.com) | Web: [www.wago.com](http://www.wago.com)

Do you have any questions about our products?

We are always happy to take your call at +49 (571) 887-44222.