

Data sheet | Item number: 2716-252

PCB terminal block; lever; 16 mm²; Pin spacing 15 mm; 2-pole; CAGE CLAMP®; commoning option; 16,00 mm²; gray

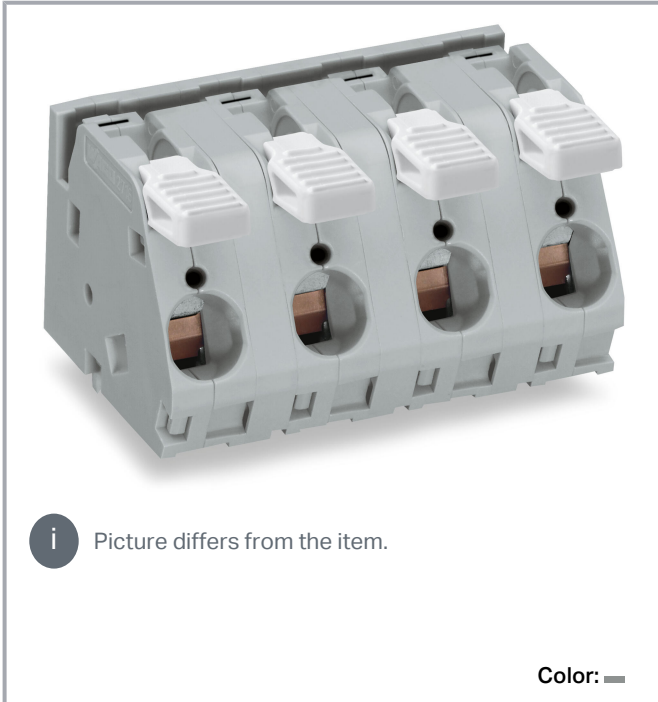

www.wago.com/2716-252



i Picture differs from the item.

Color:

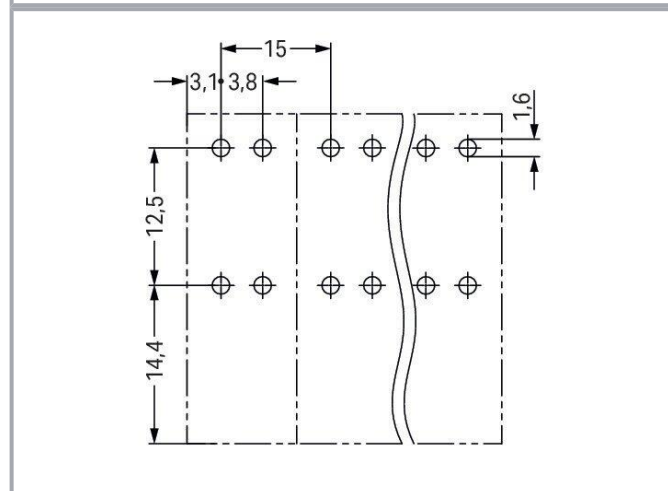
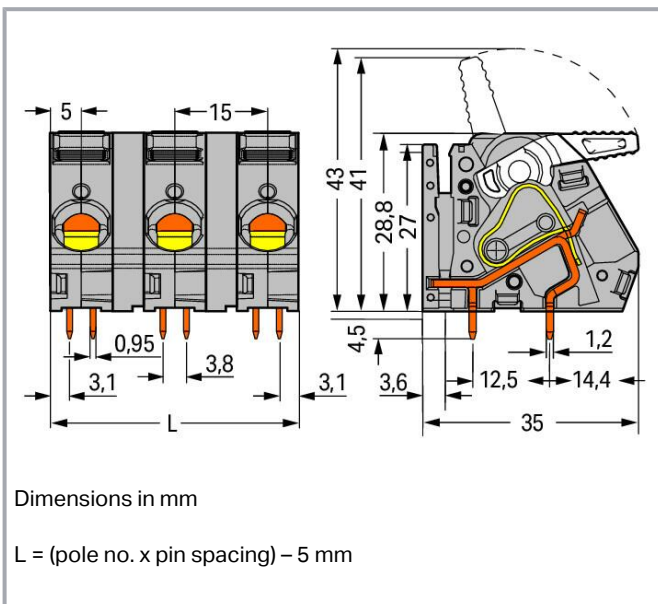
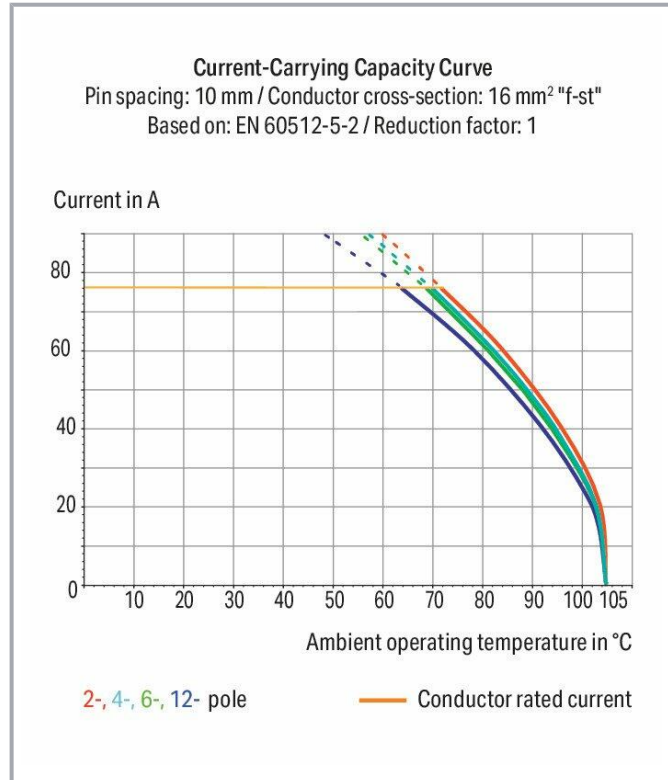

Subject to changes. Please also observe the further product documentation!

WAGO GmbH & Co. KG
Hansastr. 27
32423 Minden
Phone: +49571 887-0 | Fax: +49571 887-169
Email: info.de@wago.com | Web: www.wago.com

Do you have any questions about our products?
We are always happy to take your call at +49 (571) 887-44222.



Item description

- High-current PCB terminal strips with lever-actuated CAGE CLAMP® connection
- Tool-free termination – fingers open/close levers
- Several clamping units can be held open simultaneously, simplifying the connection of multi-core cables
- Four solder pins per contact point for high mechanical stability
- 600 V UL for 15 mm pin spacing
- Versions with optional commoning for distributing potentials

Data

Notes

Variants:

Other pole numbers

Other colors

Mixed-color PCB connector strips

Direct marking

Other versions (or variants) can be requested from WAGO Sales or configured at <https://configurator.wago.com/>.

Electrical data

Ratings per IEC/EN

Ratings per	IEC/EN 60664-1
Nominal voltage (III/3)	800 V
Rated impulse voltage (III/3)	8 kV
Rated voltage (III/2)	1000 V
Rated impulse voltage (III/2)	8 kV
Nominal voltage (II/2)	1000 V
Rated surge voltage (II/2)	8 kV
Rated current	76 A
Legend (ratings)	(III / 2) $\hat{=}$ Overvoltage category III / Pollution degree 2

Ratings per UL 1059

Approvals per	UL 1059
Rated voltage UL (Use Group B)	600 V
Rated current UL (Use Group B)	65 A
Rated voltage UL (Use Group C)	600 V
Rated current UL (Use Group C)	65 A

Subject to changes. Please also observe the further product documentation!

WAGO GmbH & Co. KG

Hansastr. 27

32423 Minden

Phone: +49571 887-0 | Fax: +49571 887-169

Email: info.de@wago.com | Web: www.wago.com

Do you have any questions about our products?

We are always happy to take your call at +49 (571) 887-44222.

Connection data

Connection points	2
Total number of potentials	2
Number of connection types	1
Number of levels	1
Number of jumper slots	1

Connection 1

Connection technology	CAGE CLAMP®
Actuation type	Lever
Solid conductor	1.5 ... 16 mm ² / 16 ... 6 AWG
Fine-stranded conductor	1.5 ... 16 mm ² / 16 ... 6 AWG
Fine-stranded conductor; with insulated ferrule	1.5 ... 10 mm ²
Fine-stranded conductor; with uninsulated ferrule	1.5 ... 10 mm ²
Strip length	12 ... 13 mm / 0.47 ... 0.51 inches
Conductor connection direction to PCB	30 °
Pole number	2

Physical data

Pin spacing	15 mm / 0.591 inches
Width	26.5 mm / 1.043 inches
Height	33.3 mm / 1.311 inches
Height from the surface	28.8 mm / 1.134 inches
Depth	35 mm / 1.378 inches
Solder pin length	4.5 mm
Solder pin dimensions	0.95 x 1.2 mm
Drilled hole diameter with tolerance	1.6 ^(+0.1) mm

PCB contact

PCB contact	THT
Solder pin arrangement	over the entire terminal strip (in-line)
Number of solder pins per potential	4

Subject to changes. Please also observe the further product documentation!



Material Data

Note (material data)

Information on material specifications can be found here

Color	gray
Material group	I
Insulation material	Polyamide (PA66)
Flammability class per UL94	V0
Clamping spring material	Chrome-nickel spring steel (CrNi)
Contact material	Electrolytic copper (E _{Cu})
Contact plating	Tin
Fire load	0.454 MJ
Weight	23.5 g

Environmental requirements

Limit temperature range	-60 ... +105 °C
-------------------------	-----------------

Commercial data

Product Group	4 (Printed Circuit Connectors)
eCl@ss 10.0	27-44-04-01
eCl@ss 9.0	27-44-04-01
ETIM 8.0	EC002643
ETIM 7.0	EC002643
PU (SPU)	40 pcs
Packaging type	box
Country of origin	PL
GTIN	4045454739485
Customs tariff number	85369010000

Environmental Product Compliance

RoHS Compliance Status	Compliant, No Exemption
------------------------	-------------------------

Approvals / Certificates





General approvals

Certificate

Subject to changes. Please also observe the further product documentation!

WAGO GmbH & Co. KG
 Hansastr. 27
 32423 Minden
 Phone: +49571 887-0 | Fax: +49571 887-169
 Email: info.de@wago.com | Web: www.wago.com

Do you have any questions about our products?
 We are always happy to take your call at +49 (571) 887-44222.

Logo	Approval	Additional Approval Text	name
	CCA DEKRA Certification B.V.	EN 60947	NTR NL-7131
	CSA DEKRA Certification B.V.	C22.2,C22.2 No. 158	1132097
	cURus Underwriters Laboratories Inc.	UL 1059	E45172
	ENEC DEKRA Certification B.V.	EN 60947	2160584.29

Optional accessories

Testing and measuring

Testing accessories









Item no.: 210-136

Test plug; 2 mm Ø; with 500 mm cable; red

www.wago.com/210-136

Ferrule

Ferrule

	Item no.: 216-104 Ferrule; Sleeve for 1.5 mm ² / AWG 16; uninsulated; electro-tin plated; silver-colored	www.wago.com/216-104
	Item no.: 216-106 Ferrule; Sleeve for 2.5 mm ² / AWG 14; uninsulated; electro-tin plated; silver-colored	www.wago.com/216-106
	Item no.: 216-107 Ferrule; Sleeve for 4 mm ² / AWG 12; uninsulated; electro-tin plated	www.wago.com/216-107
	Item no.: 216-108 Ferrule; Sleeve for 6 mm ² / AWG 10; uninsulated; electro-tin plated; silver-colored	www.wago.com/216-108
	Item no.: 216-109 Ferrule; Sleeve for 10 mm ² / AWG 8; uninsulated; electro-tin plated	www.wago.com/216-109
	Item no.: 216-124 Ferrule; Sleeve for 1.5 mm ² / AWG 16; uninsulated; electro-tin plated	www.wago.com/216-124

Subject to changes. Please also observe the further product documentation!

WAGO GmbH & Co. KG

Hansastr. 27





32423 Minden

Phone: +49571 887-0 | Fax: +49571 887-169

Email: info.de@wago.com | Web: www.wago.com

Do you have any questions about our products?

We are always happy to take your call at +49 (571) 887-44222.

	Item no.: 216-206 Ferrule; Sleeve for 2.5 mm ² / AWG 14; insulated; electro-tin plated; blue	www.wago.com/216-206
	Item no.: 216-207 Ferrule; Sleeve for 4 mm ² / AWG 12; insulated; electro-tin plated; gray	www.wago.com/216-207
	Item no.: 216-204 Ferrule; Sleeve for 1.5 mm ² / AWG 16; insulated; electro-tin plated; black	www.wago.com/216-204
	Item no.: 216-209 Ferrule; Sleeve for 10 mm ² / AWG 8; insulated; electro-tin plated; red	www.wago.com/216-209
	Item no.: 216-205 Ferrule; Sleeve for 2.08 mm ² / AWG 14; insulated; electro-tin plated; yellow	www.wago.com/216-205
	Item no.: 216-144 Ferrule; Sleeve for 1.5 mm ² / AWG 16; uninsulated; electro-tin plated; electrolytic copper; gastight crimped; acc. to DIN 46228, Part 1/08.92; silver-colored	www.wago.com/216-144
	Item no.: 216-208 Ferrule; Sleeve for 6 mm ² / AWG 10; insulated; electro-tin plated; electrolytic copper; gastight crimped; acc. to DIN 46228, Part 4/09.90; yellow	www.wago.com/216-208
	Item no.: 216-224 Ferrule; Sleeve for 1.5 mm ² / AWG 16; insulated; electro-tin plated; black	www.wago.com/216-224
	Item no.: 216-244 Ferrule; Sleeve for 1.5 mm ² / AWG 16; insulated; electro-tin plated; electrolytic copper; gastight crimped; acc. to DIN 46228, Part 4/09.90; black	www.wago.com/216-244
	Item no.: 216-246 Ferrule; Sleeve for 2.5 mm ² / AWG 14; insulated; electro-tin plated; electrolytic copper; gastight crimped; acc. to DIN 46228, Part 4/09.90; blue	www.wago.com/216-246
	Item no.: 216-266 Ferrule; Sleeve for 2.5 mm ² / AWG 14; insulated; electro-tin plated; electrolytic copper; gastight crimped; acc. to DIN 46228, Part 4/09.90; blue	www.wago.com/216-266
	Item no.: 216-264 Ferrule; Sleeve for 1.5 mm ² / AWG 16; insulated; electro-tin plated; electrolytic copper; gastight crimped; acc. to DIN 46228, Part 4/09.90; black	www.wago.com/216-264
	Item no.: 216-284 Ferrule; Sleeve for 1.5 mm ² / AWG 16; insulated; electro-tin plated; electrolytic copper; gastight crimped; acc. to DIN 46228, Part 4/09.90; black	www.wago.com/216-284
	Item no.: 216-286 Ferrule; Sleeve for 2.5 mm ² / AWG 14; insulated; electro-tin plated; electrolytic copper; gastight crimped; acc. to DIN 46228, Part 4/09.90; blue	www.wago.com/216-286
	Item no.: 216-287 Ferrule; Sleeve for 4 mm ² / AWG 12; insulated; electro-tin plated; electrolytic copper; gastight crimped; acc. to DIN 46228, Part 4/09.90; gray	www.wago.com/216-287
	Item no.: 216-288 Ferrule; Sleeve for 6 mm ² / AWG 10; insulated; electro-tin plated; electrolytic copper; gastight crimped; acc. to DIN 46228, Part 4/09.90; yellow	www.wago.com/216-288
	Item no.: 216-289 Ferrule; Sleeve for 10 mm ² / AWG 8; insulated; electro-tin plated; electrolytic copper; gastight crimped;	www.wago.com/216-289

Subject to changes. Please also observe the further product documentation!

acc. to DIN 46228, Part 4/09.90; red



Item no.: 216-267

Ferrule; Sleeve for 4 mm² / AWG 12; insulated; electro-tin plated; electrolytic copper; gastight crimped; www.wago.com/216-267
acc. to DIN 46228, Part 4/09.90; gray

Jumpers

Jumper



Item no.: 745-631

Jumper; 2-way; unplated; silver-colored

www.wago.com/745-631



Item no.: 745-633

Jumper; 3-way; unplated; silver-colored

www.wago.com/745-633



Item no.: 745-634

Jumper; 4-way; silver-colored

www.wago.com/745-634



Item no.: 745-632

Jumper; 2-way; silver-colored

www.wago.com/745-632



Item no.: 745-635

Jumper; 5-way; unplated; silver-colored

www.wago.com/745-635

Downloads

Documentation

Additional Information

Technical Section	2019 Apr 3	pdf	Download
Technical explanations		2.0 MB	

CAD/CAE-Data

CAD data

2D/3D Models 2716-252	URL	Download
-----------------------	-----	----------

PCB Design

Symbol and Footprint 2716-252	URL	Download
-------------------------------	-----	----------

CAX data for your PCB design, consisting of "schematic symbols and PCB footprints", allow easy integration of the WAGO component into your development environment.

Supported formats:

- Accel EDA 14 & 15
- Altium 6 to current version

Subject to changes. Please also observe the further product documentation!



- Cadence Allegro
- DesignSpark
- Eagle Libraries
- KiCad
- Mentor Graphics BoardStation
- Mentor Graphics Design Architect
- Mentor Graphics Design Expedition 99 and 2000
- OrCAD 9.X PCB and Capture
- PADS PowerPCB 3, 3.5, 4.X, and 5.X
- PADS PowerPCB and PowerLogic 3.0
- PCAD 2000, 2001, 2002, 2004, and 2006
- Pulsonix 8.5 or newer
- STL
- 3D STEP
- TARGET 3001!
- View Logic ViewDraw
- Quadcept
- Zuken CadStar 3 and 4
- Zuken CR-5000 and CR-8000

PCB Component Libraries (EDA), PCB CAD Library Ultra Librarian

CAE data

ZUKEN Portal 2716-252	URL	Download
-----------------------	---------------------	--------------------------

Environmental Product Compliance

Compliance Search

Environmental Product Compliance 2716-252 PCB terminal block; lever; 16 mm ² ; Pin spacing 15 mm; 2-pole; CAGE CLAMP®; commoning option; 16,00 mm ² ; gray	URL	Download
----------------------------------------------------------------------------------------------------------------------------------------------------------------------------------------	---------------------	--------------------------

Installation Notes

Conductor termination

Subject to changes. Please also observe the further product documentation!

WAGO GmbH & Co. KG
Hansastr. 27
32423 Minden
Phone: +49571 887-0 | Fax: +49571 887-169
Email: info.de@wago.com | Web: www.wago.com

Do you have any questions about our products?
We are always happy to take your call at +49 (571) 887-44222.



To open the clamping unit, pull the operating lever all the way back — 2706 and 2716 Series.

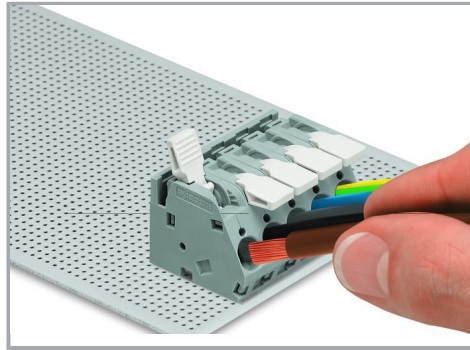

Inserting/removing a conductor – 2706 and 2716 Series.

Testing

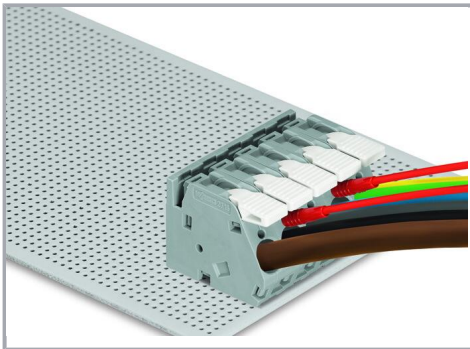

Testing with test plug – 2706 and 2716 Series.

Commoning

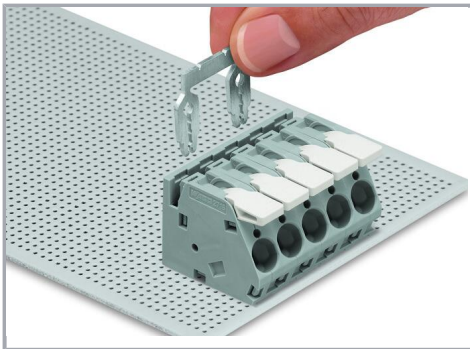

Inserting a comb-style jumper bar.

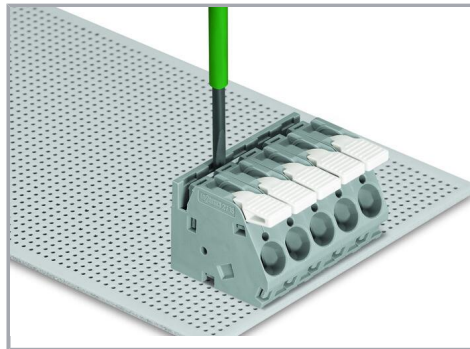

Push jumper bar down firmly using a screwdriver until it hits the backstop – 2706 and 2716 Series.

Subject to changes. Please also observe the further product documentation!

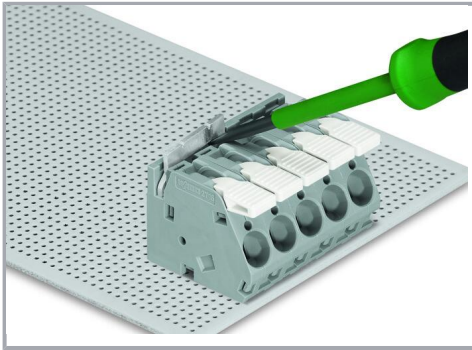

To remove the comb-style jumper bar, lift it up using a screwdriver – 2706 and 2716 Series.

Subject to changes. Please also observe the further product documentation!