

CMPA0530002S

2 W, 0.5 - 3.0 GHz, 28 V, GaN MMIC

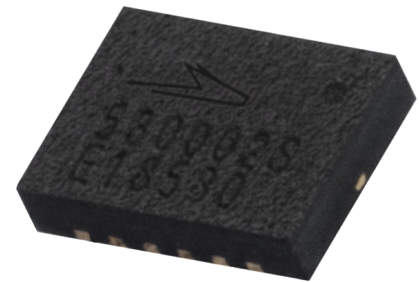

Description

Wolfspeed's CMPA0530002S is a packaged gallium nitride (GaN) High Electron Mobility Transistor (HEMT) based monolithic microwave integrated circuit (MMIC). The MMIC power amplifier is matched to 50-ohms on the input. The CMPA0530002S operates on a 28 volt rail while housed in a 3mm x 4mm; surface mount; dual-flat-no-lead (DFN) package. Under reduced power; the transistor can operate below 28V to as low as 20V V_{DD} ; maintaining high gain and efficiency.

Package Type: 3x4 DFN
PN: CMPA0530002S

Typical Performance Over 0.5 - 3.0 GHz ($T_c = 25^\circ\text{C}$), 28 V

Parameter	0.5 GHz	1.0 GHz	1.5 GHz	2.0 GHz	2.5 GHz	3.0 GHz	Units
Small Signal Gain	18.10	17.90	18.30	17.90	17.90	17.52	dB
Output Power ¹	2.85	2.80	2.99	2.99	2.84	2.90	W
Power Gain ¹	13.05	12.97	13.26	13.25	13.04	13.12	dB
Power Added Efficiency ¹	56.0	48.7	56.2	51.2	46.0	49.1	%

¹Note: $P_{IN} = 21.5$ dBm, CW

Features for 28 V in CMPA0530002S-AMP

- 18 dB Small Signal Gain
- 2.9 W Typical P_{SAT}
- Operation up to 28 V
- High Breakdown Voltage
- High Temperature Operation
- Size 0.118 x 0.157 x 0.033 inches

Applications

- Civil and Military Communications
- Broadband Amplifiers
- Electronic Warfare
- Industrial, Scientific & Medical
- Radar

 Large Signal Models Available for ADS and MWO





Absolute Maximum Ratings (not simultaneous) at 25°C Case Temperature

Parameter	Symbol	Rating	Units	Conditions
Drain-Source Voltage	V_{DSS}	84	V	25°C
Gate-to-Source Voltage	V_{GS}	-10, +2		
Storage Temperature	T_{STG}	-65, +150	°C	
Operating Junction Temperature	T_J	225		
Maximum Forward Gate Current	I_{GMAX}	0.8	mA	25°C
Maximum Drain Current ¹	I_{DMAX}	0.33	A	
Soldering Temperature ²	T_S	245	°C	
Thermal Resistance, Junction to Case ⁵	$R_{\theta JC}$	24.0	°C/W	85°C

Notes:

¹ Current limit for long term, reliable operation

² Refer to the Application Note on soldering at wolfspeed.com/rf/document-library

³ Simulated at $P_{DISS} = 2.2$ W

⁴ T_C = Case temperature for the device. It refers to the temperature at the ground tab underneath the package. The PCB will add additional thermal resistance

⁵ The R_{TH} for Wolfspeed's application circuit, CMPA0530002S-AMP1, with 15 (Ø13 mil) via holes designed on a 20 mil thick Rogers 4350B PCB, is 24°C/W. The total R_{TH} from the heat sink to the junction is 24°C/W + 6.5°C/W = 30.5°C/W

Electrical Characteristics ($T_C = 25^\circ\text{C}$), 28 V Typical

Characteristics	Symbol	Min.	Typ.	Max.	Units	Conditions
DC Characteristics¹						
Gate Threshold Voltage	$V_{GS(th)}$	-3.6	-3.1	-2.4	V	$V_{DS} = 10$ V, $I_D = 0.8$ mA
Gate Quiescent Voltage	$V_{GS(Q)}$	–	-2.4	–	mA	$V_{DS} = 28$ V, $I_D = 90$ mA
Saturated Drain Current ²	I_{DS}	0.58	0.8	–	A	$V_{DS} = 6.0$ V, $V_{GS} = 2.0$ V
Drain-Source Breakdown Voltage	$V_{BR(DSS)}$	84	–	–	V	$V_{GS} = -8$ V, $I_D = 0.8$ mA
RF Characteristics^{3,4} ($T_C = 25^\circ\text{C}$, $F_0 = 3.0$ GHz unless otherwise noted)						
Small Signal Gain	S_{21}	–	16.4	–	dB	$V_{DS} = 28$ V, $I_{DQ} = 90$ mA
Input Return Loss	S_{11}	–	-19.3	–		
Output Return Loss	S_{22}	–	-14.7	–		
Output Power	P_{OUT}	–	33.5	–	dBm	
Drain Efficiency	η	–	52	–	%	
Output Mismatch Stress	VSWR	–	–	10:1	Ψ	No damage at all phase angles, $V_{DD} = 28$ V, $I_{DQ} = 90$ mA, $P_{IN} = 23$ dBm

Notes:

¹ Measured on wafer prior to packaging.

² Scaled from PCM data

³ Measured in CMPA0530002S high volume test fixture at 3.0 GHz and may not show the full capability of the device due to source inductance and thermal performance.

⁴ $P_{IN} = 23$ dBm, CW



Electrical Characteristics When Tested in CMPA0530002S-AMP1 at 0.5 - 3.0 GHz, CW

Characteristics	Symbol	Typ.	Max.	Units	Conditions
RF Characteristics¹ ($T_c = 25^\circ\text{C}$, $F_0 = 0.5 - 3.0$ GHz unless otherwise noted)					
Gain ²	G	13.2	–	dB	$V_{DD} = 28$ V, $I_{DQ} = 90$ mA, $P_{IN} = 21.5$ dBm
Output Power ²	P_{OUT}	34.6	–	dBm	
Power Added Efficiency ²	η	51	–	%	
Output Mismatch Stress ²	VSWR	–	10:1	Ψ	No damage at all phase angles, $V_{DS} = 28$ V, $I_{DQ} = 90$ mA

Notes:

¹ Measured in CMPA0530002S-AMP1 Application Circuit

² CW



Typical Performance of the CPMA0530002S

Test conditions unless otherwise noted: $V_{DD} = 28\text{ V}$, $I_{DQ} = 90\text{ mA}$, CW, $P_{IN} = 21.5\text{ dBm}$, Frequency = 2 GHz, $T_{BASE} = +25^\circ\text{C}$

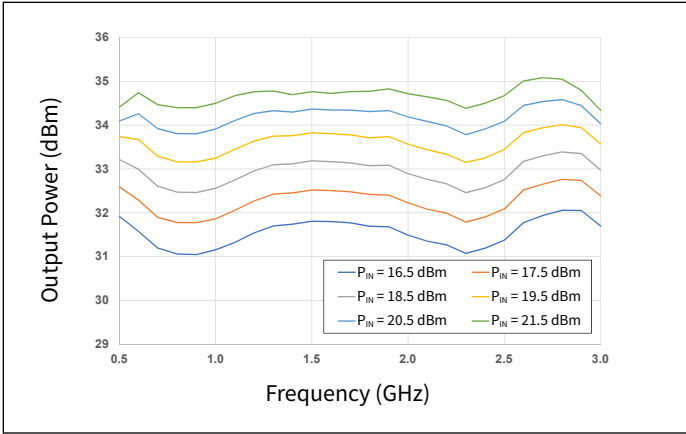

Figure 1. Output Power vs Frequency as a Function of Input Power

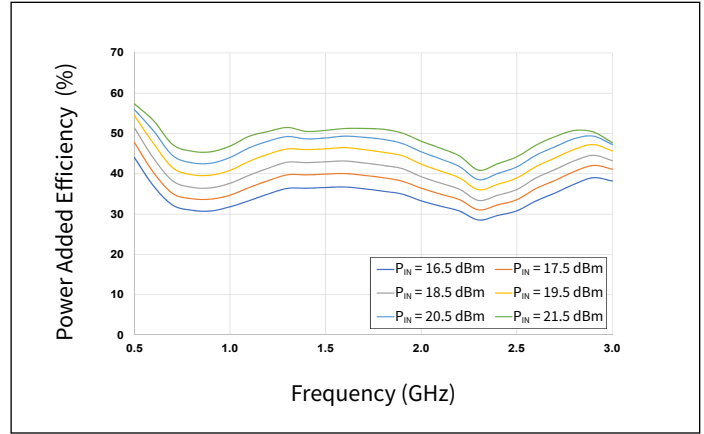

Figure 2. Power Added Efficiency vs Frequency as a Function of Input Power

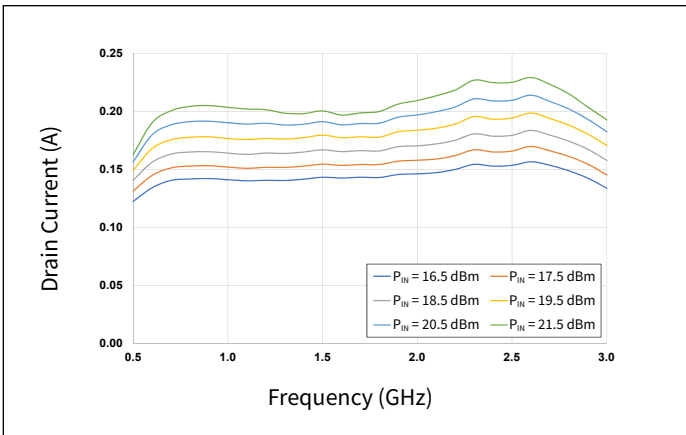

Figure 3. Drain Current vs Frequency as a Function of Input Power

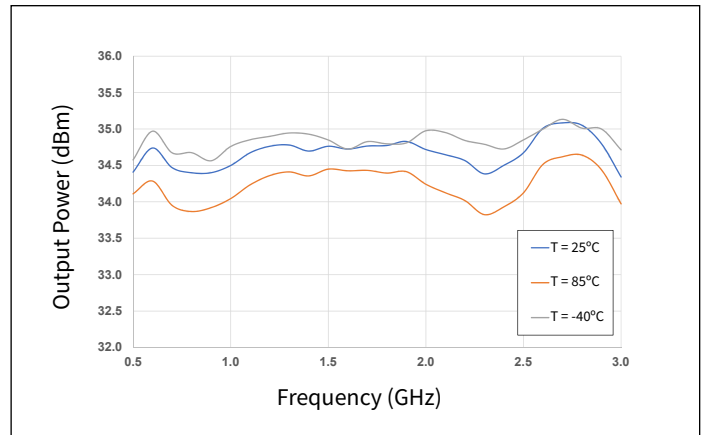

Figure 4. Output Power vs Frequency as a Function of Temperature

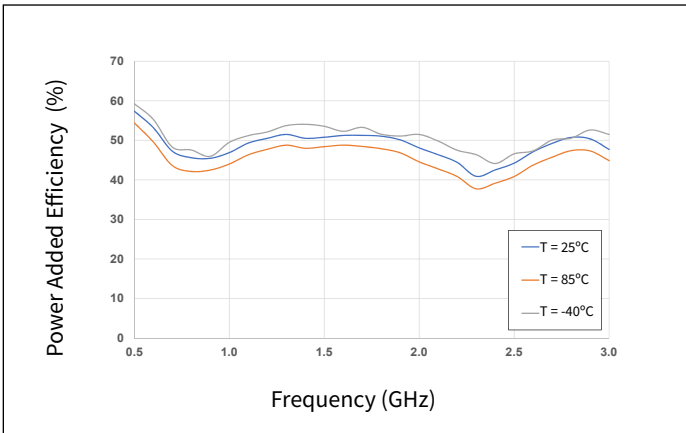

Figure 5. Power Added Efficiency vs Frequency as a Function of Temperature

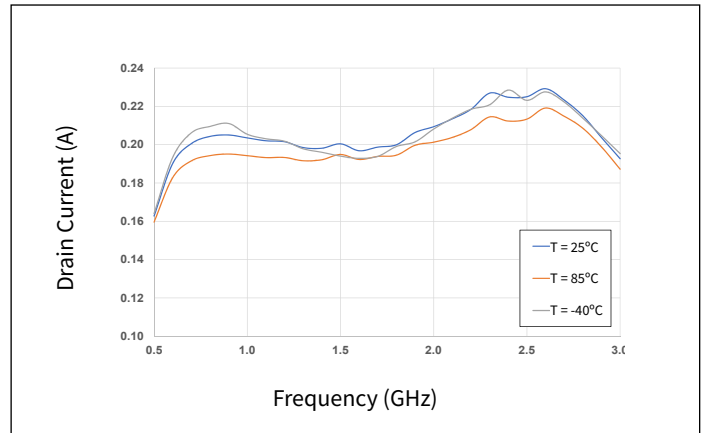

Figure 6. Drain Current vs Frequency as a Function of Temperature



Typical Performance of the CPMA0530002S

Test conditions unless otherwise noted: $V_{DD} = 28\text{ V}$, $I_{DQ} = 90\text{ mA}$, CW, $P_{IN} = 21.5\text{ dBm}$, Frequency = 2 GHz, $T_{BASE} = +25^\circ\text{C}$

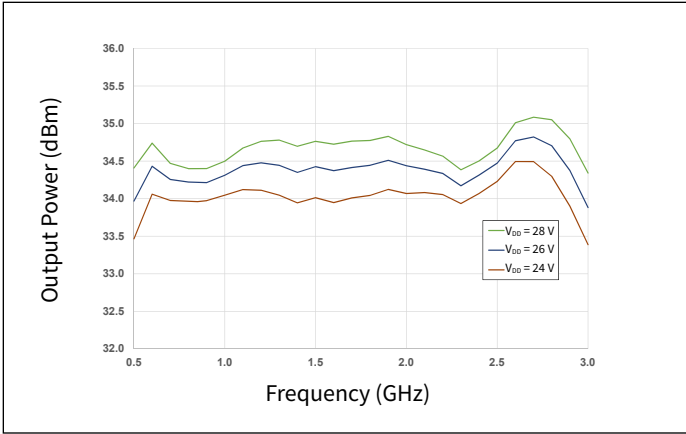

Figure 7. Output Power vs Frequency as a Function of Drain Voltage

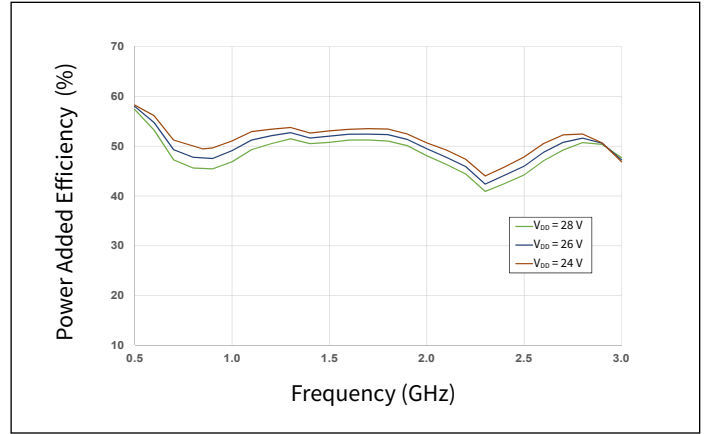

Figure 8. Power Added Efficiency vs Frequency as a Function of Drain Voltage

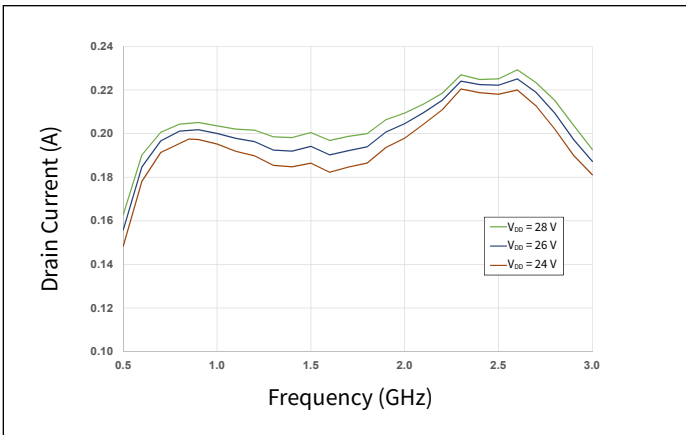

Figure 9. Drain Current vs Frequency as a Function of Drain Voltage

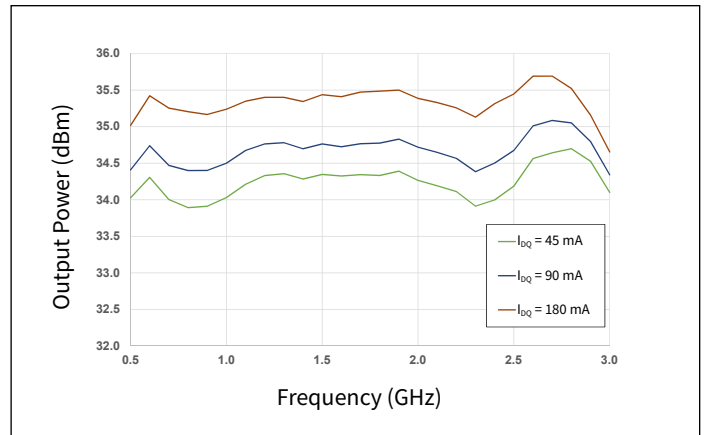

Figure 10. Output Power vs Frequency as a Function of I_{DQ}

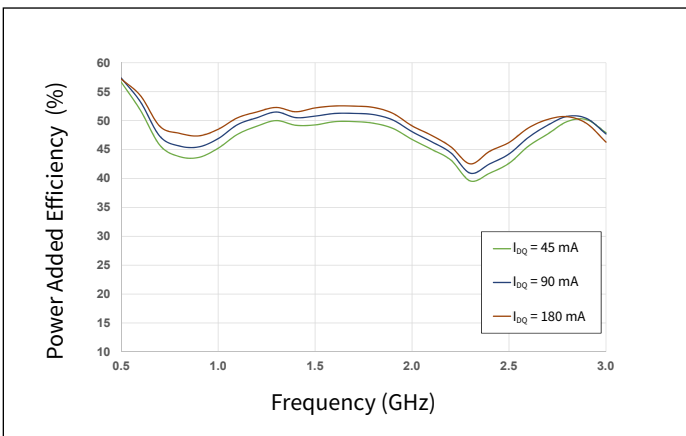

Figure 11. Power Added Efficiency vs Frequency as a Function of I_{DQ}

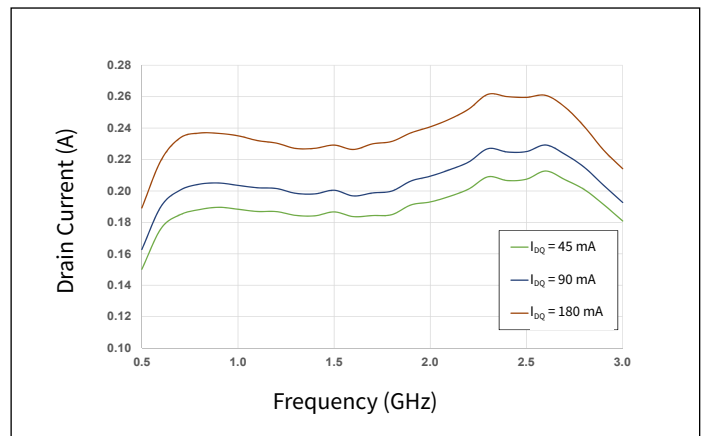

Figure 12. Drain Current vs Frequency as a Function of I_{DQ}



Typical Performance of the CPMA0530002S

Test conditions unless otherwise noted: $V_{DD} = 28\text{ V}$, $I_{DQ} = 90\text{ mA}$, CW, $P_{IN} = 21.5\text{ dBm}$, Frequency = 2 GHz, $T_{BASE} = +25^\circ\text{C}$

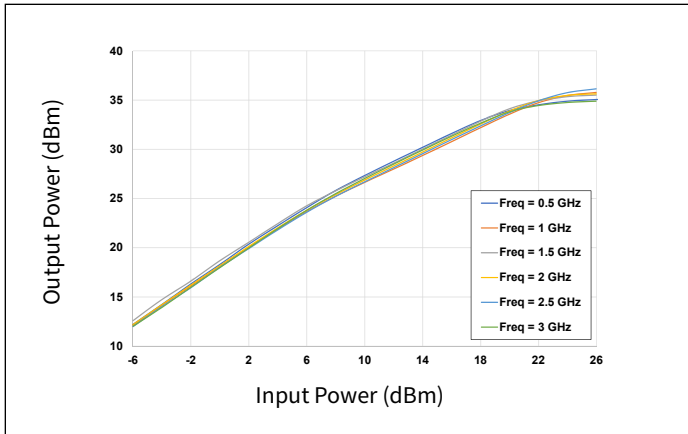

Figure 13. Output Power vs Input Power as a Function of Frequency

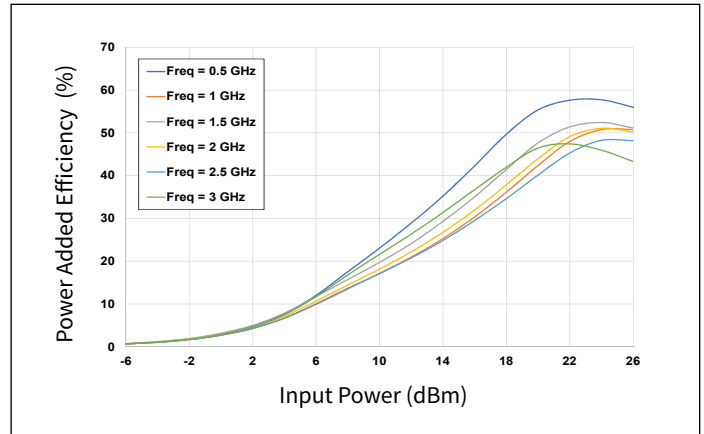

Figure 14. Power Added Efficiency vs Input Power as a Function of Frequency

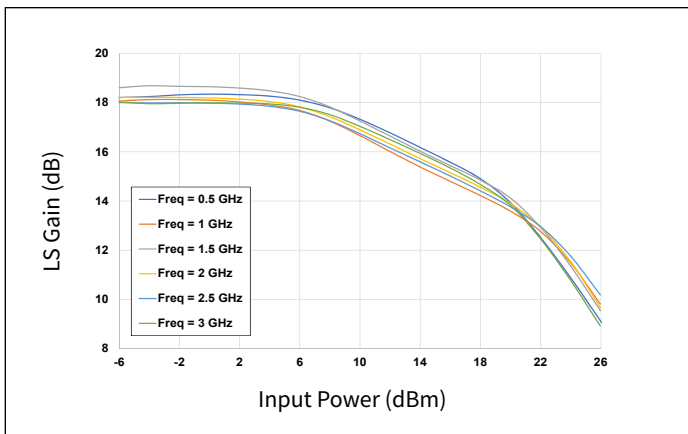

Figure 15. Large Signal Gain vs Input Power as a Function of Frequency

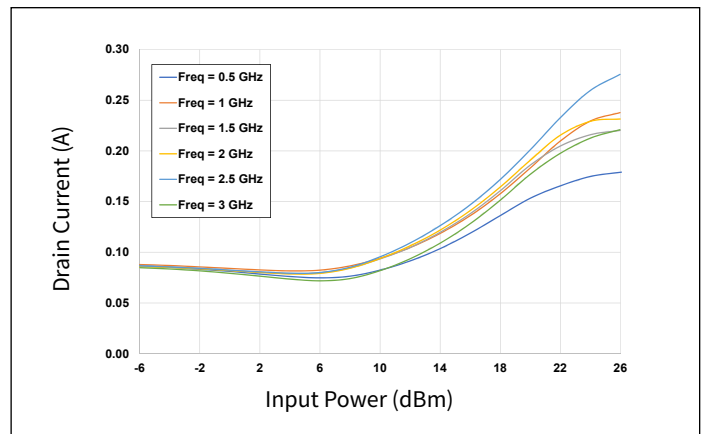

Figure 16. Drain Current vs Input Power as a Function of Frequency

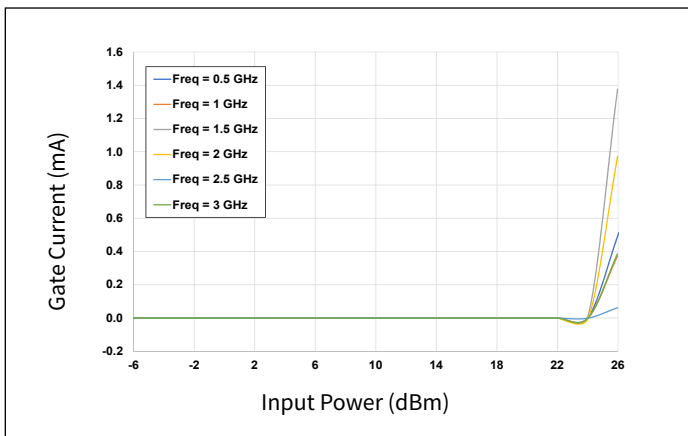

Figure 17. Gate Current vs Input Power as a Function of Frequency

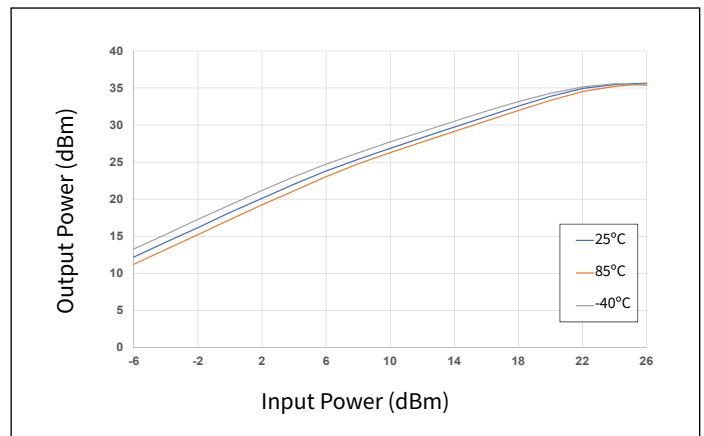

Figure 18. Output Power vs Input Power as a Function of Temperature



Typical Performance of the CMPA0530002S

Test conditions unless otherwise noted: $V_{DD} = 28\text{ V}$, $I_{DQ} = 90\text{ mA}$, CW, $P_{IN} = 21.5\text{ dBm}$, Frequency = 2 GHz, $T_{BASE} = +25^\circ\text{C}$

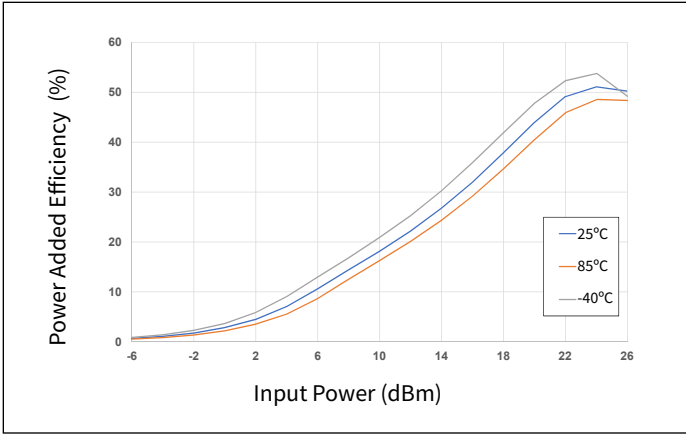

Figure 19. Power Added Efficiency vs Input Power as a Function of Temperature

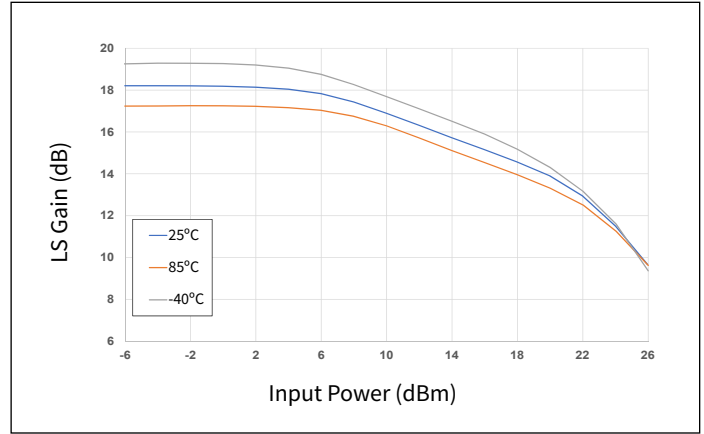

Figure 20. Large Signal Gain vs Input Power as a Function of Temperature

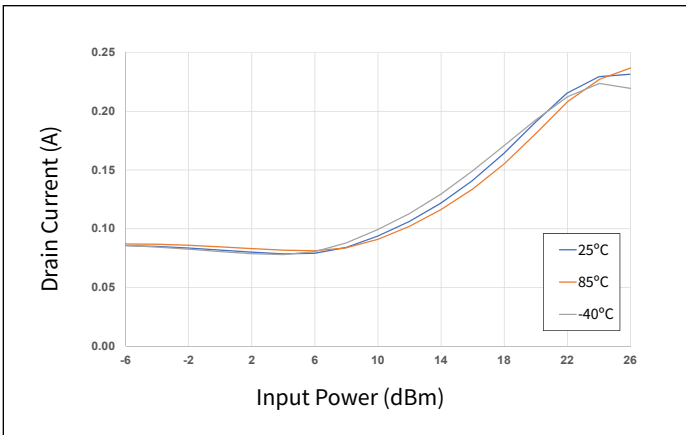

Figure 21. Drain Current vs Input Power as a Function of Temperature

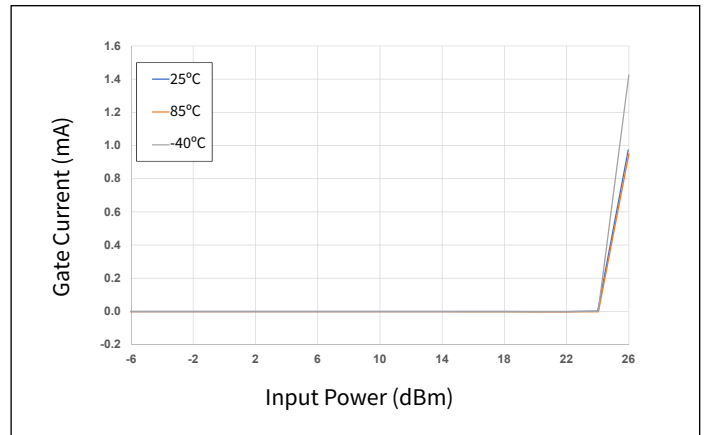

Figure 22. Gate Current vs Input Power as a Function of Temperature

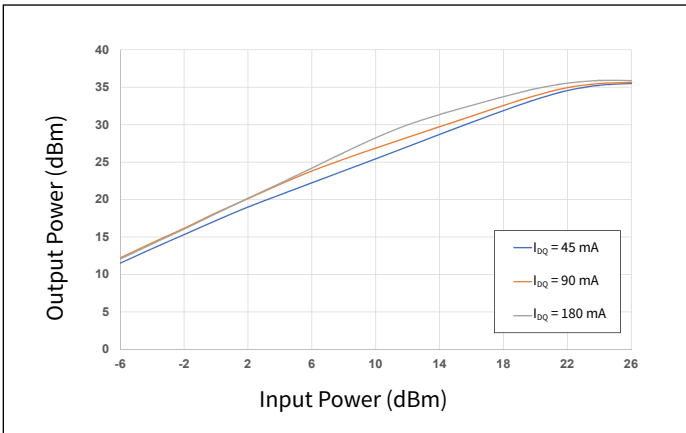

Figure 23. Output Power vs Input Power as a Function of I_{DQ}

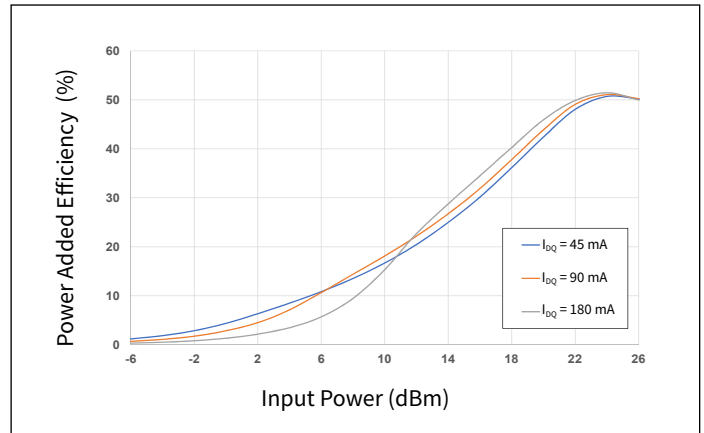

Figure 24. Power Added Efficiency vs Input Power as a Function of I_{DQ}



Typical Performance of the CPM0530002S

Test conditions unless otherwise noted: $V_{DD} = 28\text{ V}$, $I_{DQ} = 90\text{ mA}$, CW, $P_{IN} = 21.5\text{ dBm}$, Frequency = 2 GHz, $T_{BASE} = +25^\circ\text{C}$

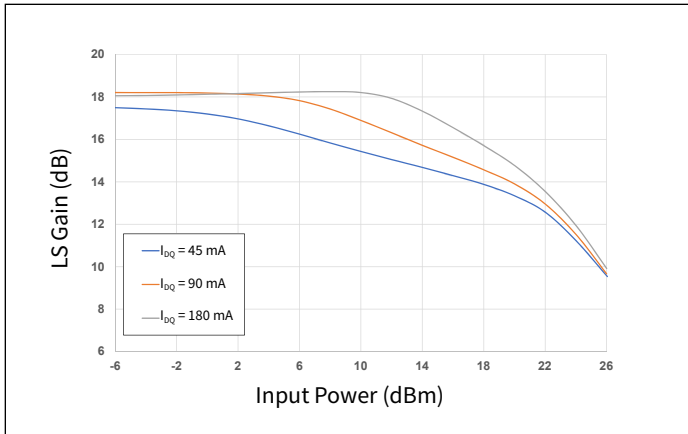

Figure 25. Large Signal Gain vs Input Power as a Function of I_{DQ}

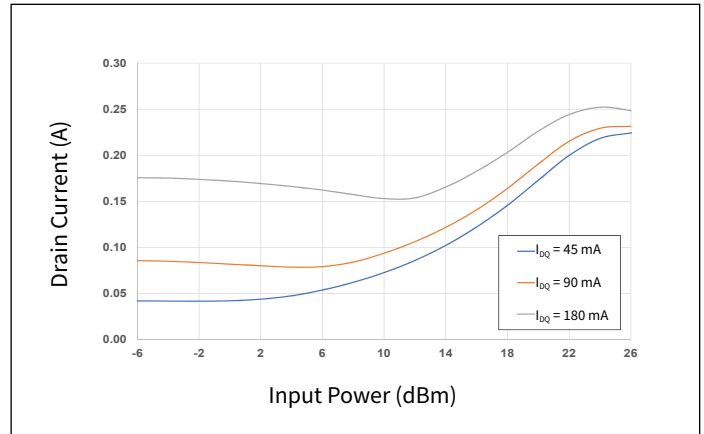

Figure 26. Drain Current vs Input Power as a Function of I_{DQ}

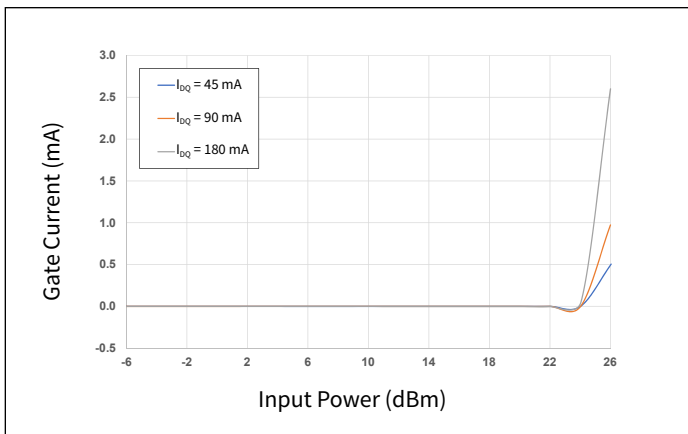

Figure 27. Gate Current vs Input Power as a Function of I_{DQ}

Typical Performance of the CPM0530002S

Test conditions unless otherwise noted: $V_{DD} = 28\text{ V}$, $I_{DQ} = 90\text{ mA}$, CW, $P_{IN} = 21.5\text{ dBm}$, Frequency = 2 GHz, $T_{BASE} = +25^\circ\text{C}$

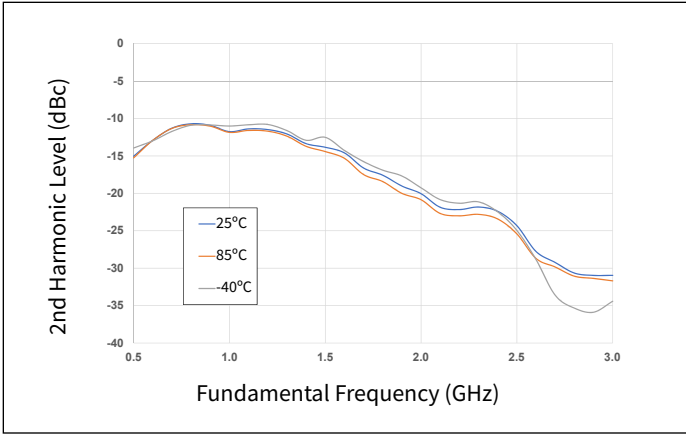

Figure 28. 2nd Harmonic vs Frequency as a Function of Temperature

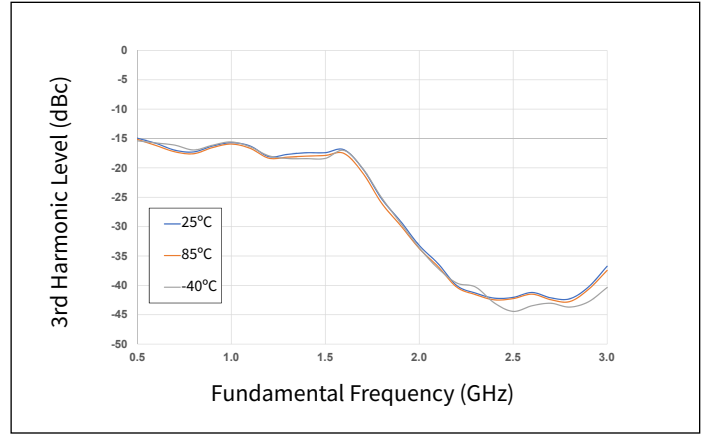

Figure 29. 3rd Harmonic vs Frequency as a Function of Temperature

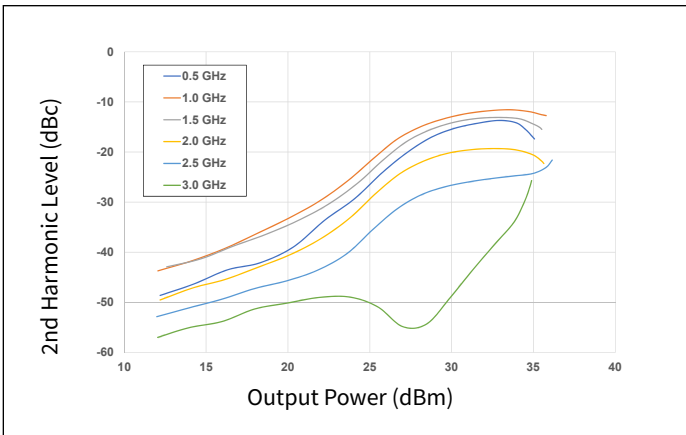

Figure 30. 2nd Harmonic vs Output Power as a Function of Frequency

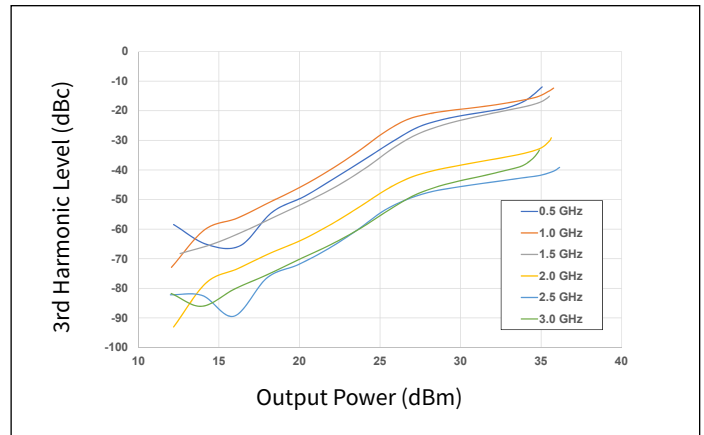

Figure 31. 3rd Harmonic vs Output Power as a Function of Frequency

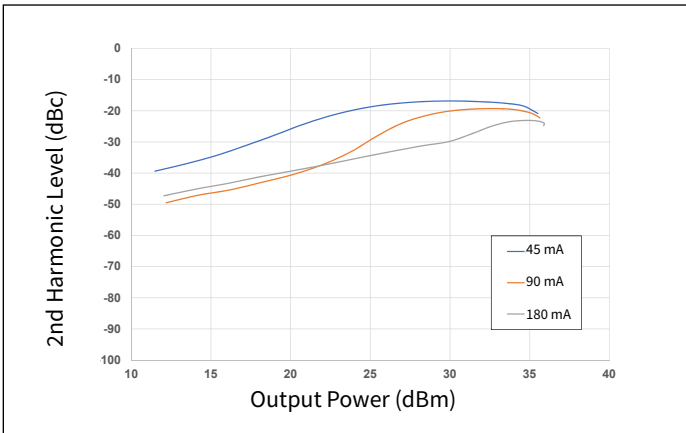

Figure 32. 2nd Harmonic vs Output Power as a Function of I_{DQ}

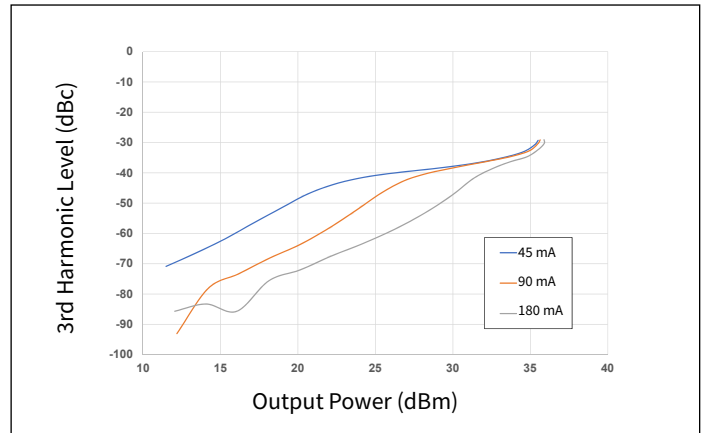

Figure 33. 3rd Harmonic vs Output Power as a Function of I_{DQ}



Typical Performance of the CPMA0530002S

Test conditions unless otherwise noted: $V_{DD} = 28\text{ V}$, $I_{DQ} = 90\text{ mA}$, CW, $P_{IN} = 21.5\text{ dBm}$, Frequency = 2 GHz, $T_{BASE} = +25^\circ\text{C}$

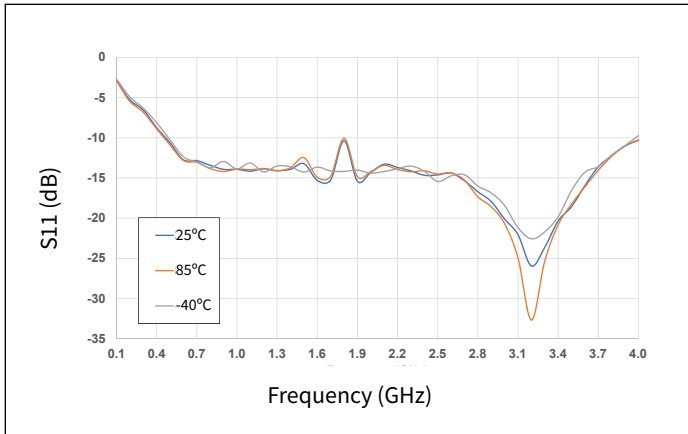

Figure 34. Input RL vs Frequency as a Function of Temperature

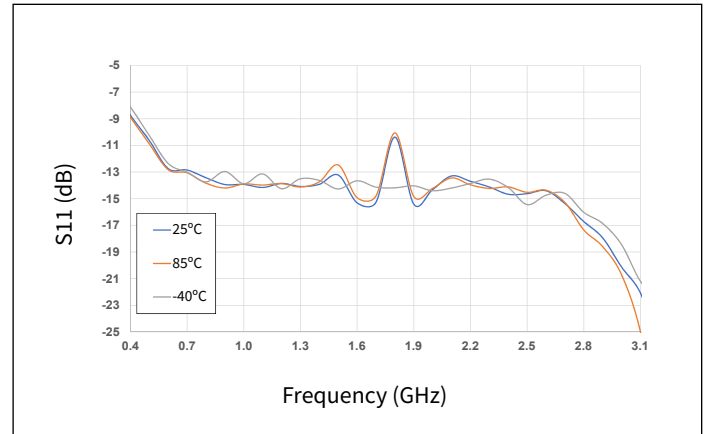

Figure 35. Input RL vs Frequency as a Function of Temperature

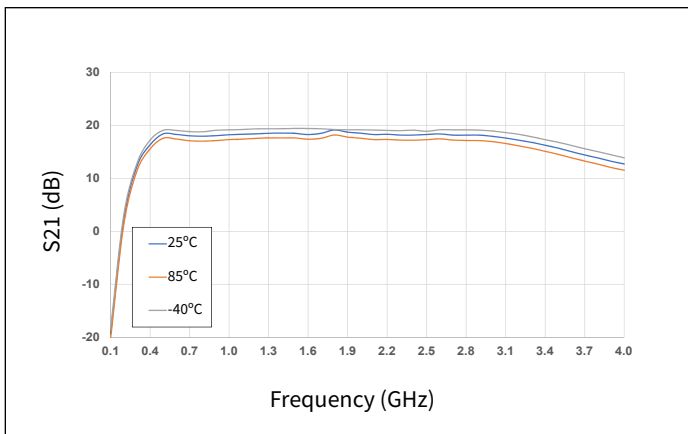

Figure 36. Gain vs Frequency as a Function of Temperature

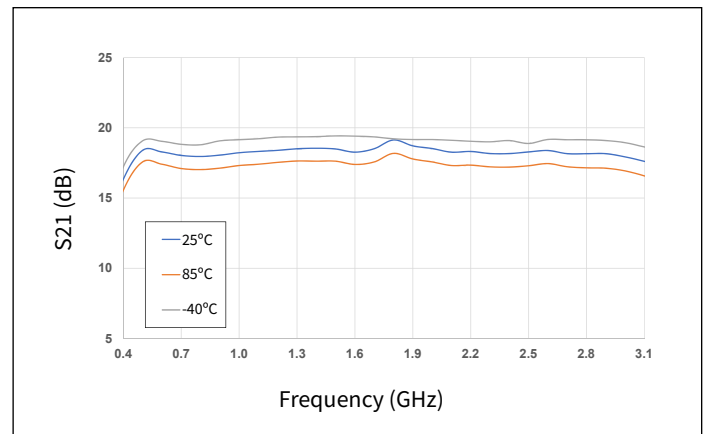

Figure 37. Gain vs Frequency as a Function of Temperature

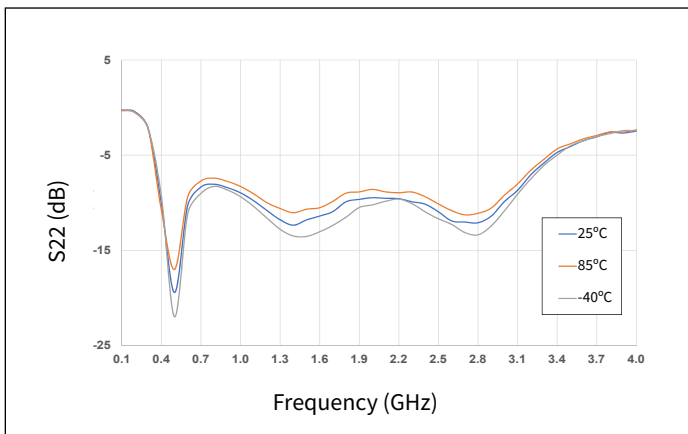

Figure 38. Output RL vs Frequency as a Function of Temperature

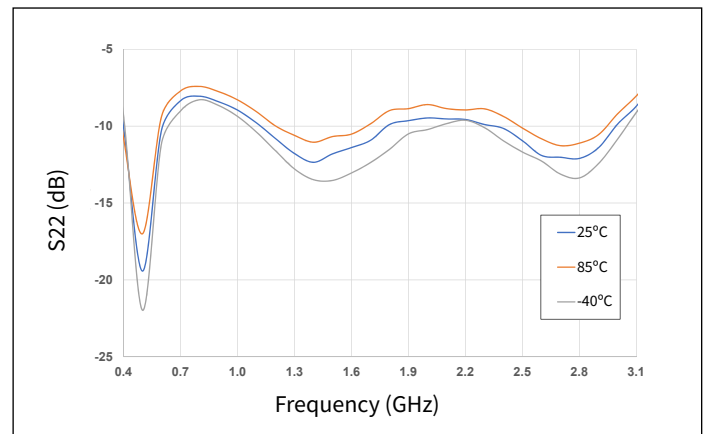

Figure 39. Output RL vs Frequency as a Function of Temperature



Typical Performance of the CPM0530002S

Test conditions unless otherwise noted: $V_{DD} = 28\text{ V}$, $I_{DQ} = 90\text{ mA}$, CW, $P_{IN} = 21.5\text{ dBm}$, Frequency = 2 GHz, $T_{BASE} = +25^\circ\text{C}$

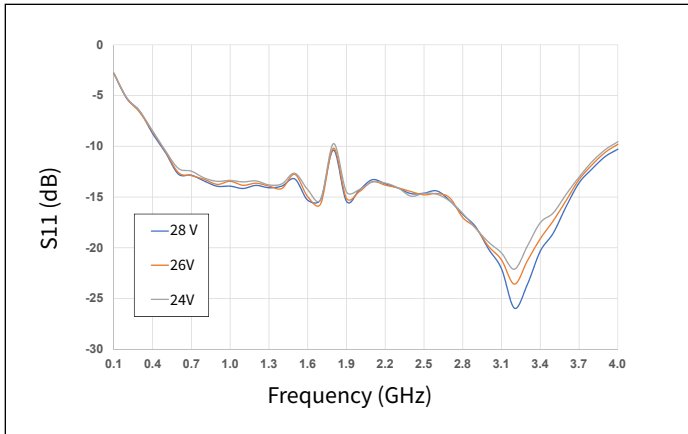

Figure 40. Input RL vs Frequency as a Function of Drain Voltage

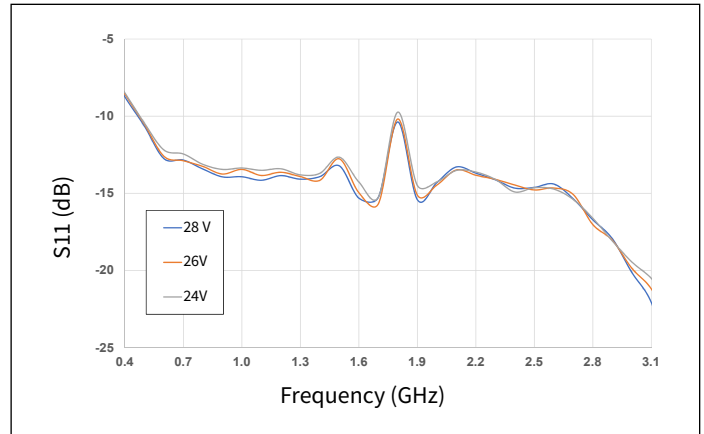

Figure 41. Input RL vs Frequency as a Function of Drain Voltage

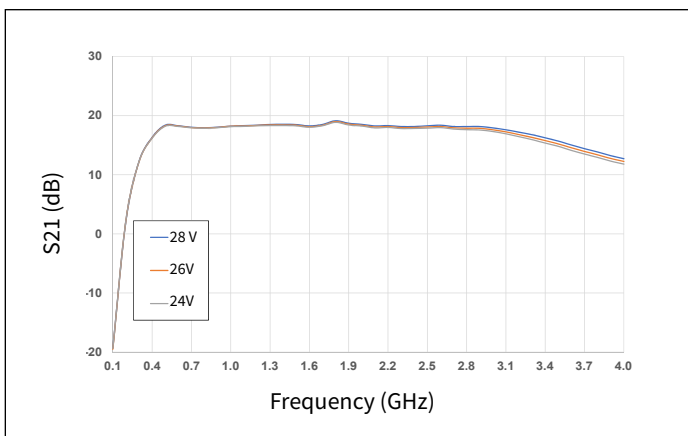

Figure 42. Gain vs Frequency as a Function of Drain Voltage

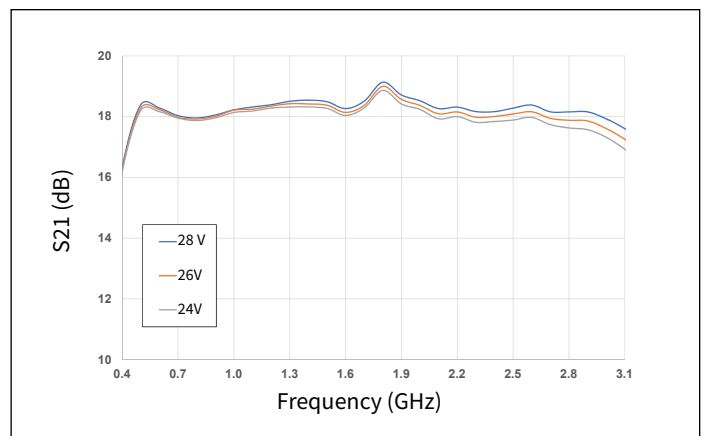

Figure 43. Gain vs Frequency as a Function of Drain Voltage

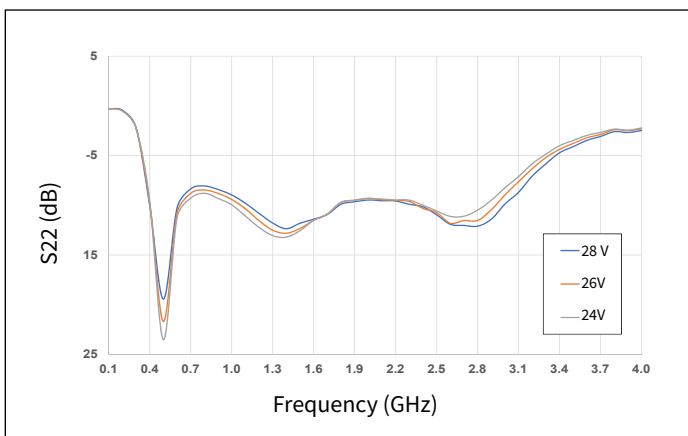

Figure 44. Output RL vs Frequency as a Function of Drain Voltage

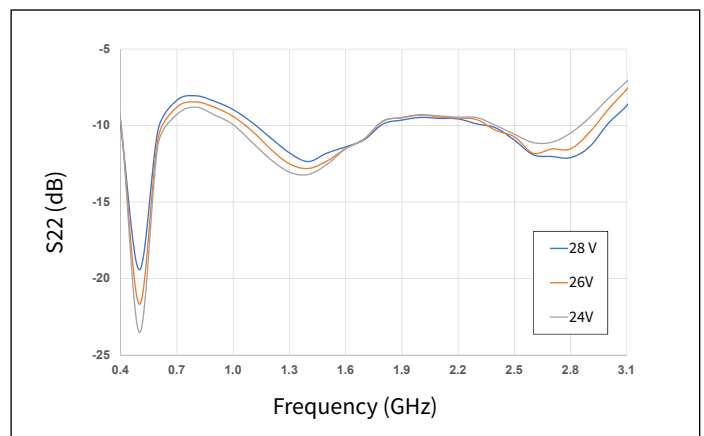

Figure 45. Output RL vs Frequency as a Function of Drain Voltage



Typical Performance of the CPMA0530002S

Test conditions unless otherwise noted: $V_{DD} = 28\text{ V}$, $I_{DQ} = 90\text{ mA}$, CW, $P_{IN} = 21.5\text{ dBm}$, Frequency = 2 GHz, $T_{BASE} = +25^\circ\text{C}$

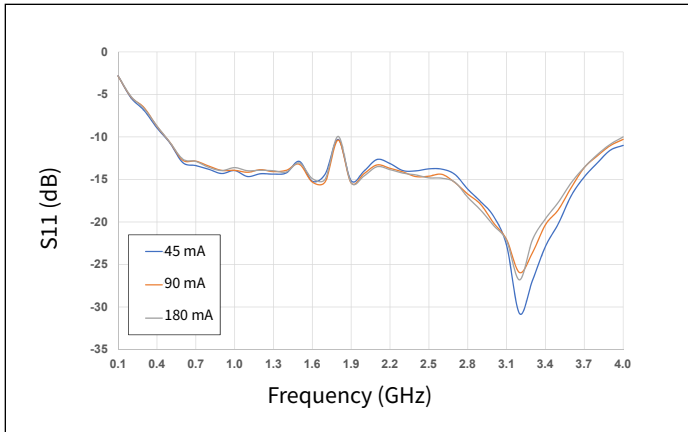

Figure 46. Input RL vs Frequency as a Function of I_{DQ}

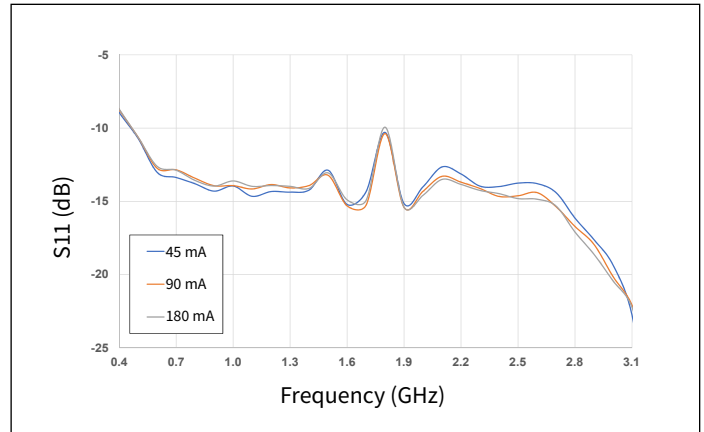

Figure 47. Input RL vs Frequency as a Function of I_{DQ}

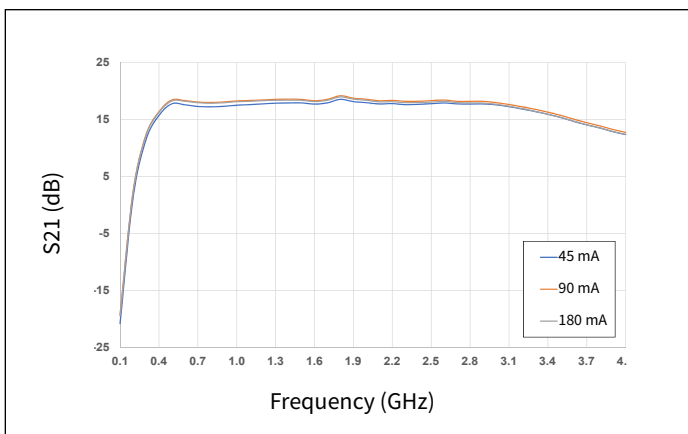

Figure 48. Gain vs Frequency as a Function of I_{DQ}

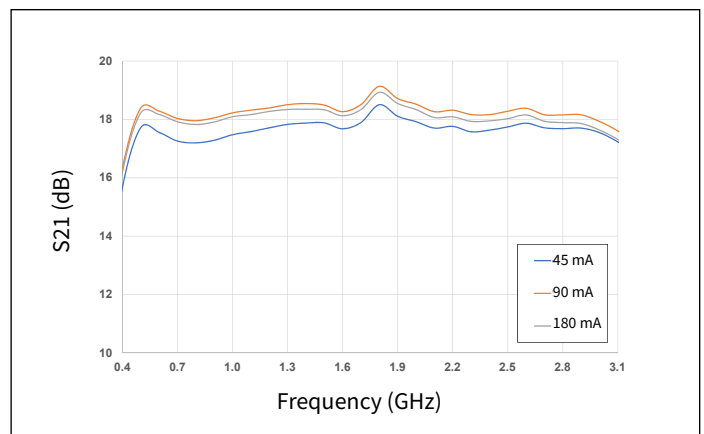

Figure 49. Gain vs Frequency as a Function of I_{DQ}

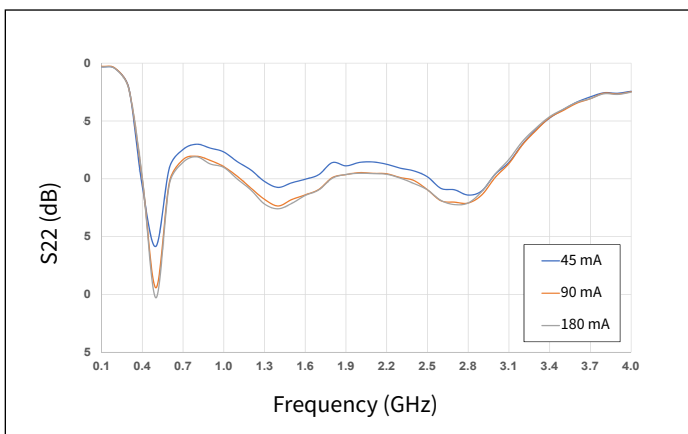

Figure 50. Output RL vs Frequency as a Function of I_{DQ}

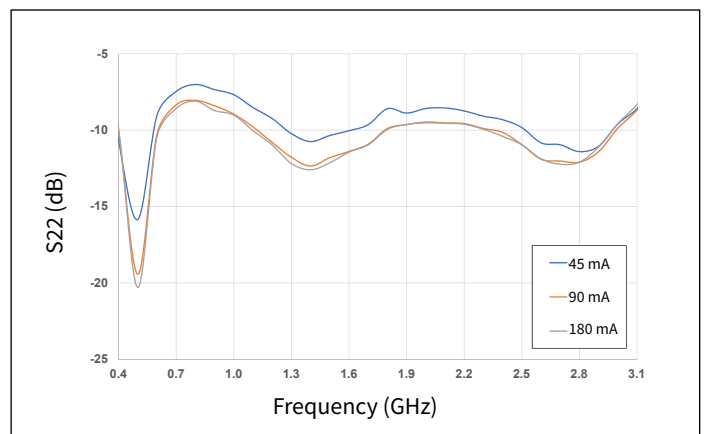

Figure 51. Output RL vs Frequency as a Function of I_{DQ}



CMPA0530002S-AMP1 Application Circuit Bill of Materials

Designator	Description	Qty
C1	CAP, 15pF, 5%, 0603, ATC600S	1
C2	CAP, 3.6pF, 5%, 0603, ATC600S	1
C4	CAP, 56pF, 5%, 0603, ATC600S	1
C8, C9	CAP, 100pF, 5%, 0603, ATC600S	2
C7, C10	CAP, 470pF, 5%, 100V, 0603, X7R, AVX	2
C6, C11	CAP, 1.0μF, 100V, 10%, X7R, 1210, muRata	2
C12	CAP, 33μF, 20%, G CASE, Panasonic	1
C13	CAP, 10μF, 16V, TANTALUM, 2312, AVX	1
L1	INDUCTOR, CHIP, 3.3nH, 0603 SMT, Coilcraft	1
L2	INDUCTOR, CHIP, 22nH, 0603 SMT, Coilcraft	1
L3	INDUCTOR, CHIP, 1.8nH, 0603 SMT, Coilcraft	1
L4	INDUCTOR, CHIP, 33nH, 0603 SMT, Coilcraft	1
L5	INDUCTOR, CHIP, 1.6nH, 0603 SMT, Coilcraft	1
Q1	MMIC, GaN HEMT, DFN3x4, CMPA0530002S	1
	PCB, RO4350B, 0.020 THK, CMPA0530002S	1
	BASEPLATE, AL, 2.60 X 1.7 X 0.25	1
	2-56 SOC HD SCREW 1/4 SS	4
	#2 SPLIT LOCKWASHER SS	4
J1, J2	CONN, SMA, PANEL MOUNT JACK, FLANGE	2
J3	HEADER RT>PLZ .1CEN LK 5POS	1
W1	Wire, Black, 22 AWG, ~ 1"	1

CMPA0530002S-AMP1 Application Circuit

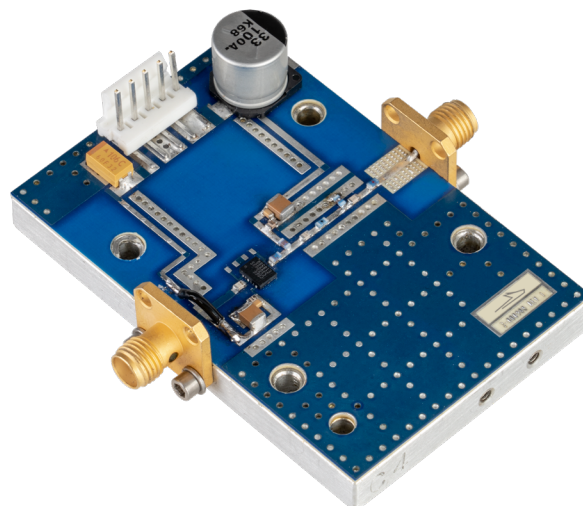



CMPA0530002S-AMP1 Application Circuit Schematic

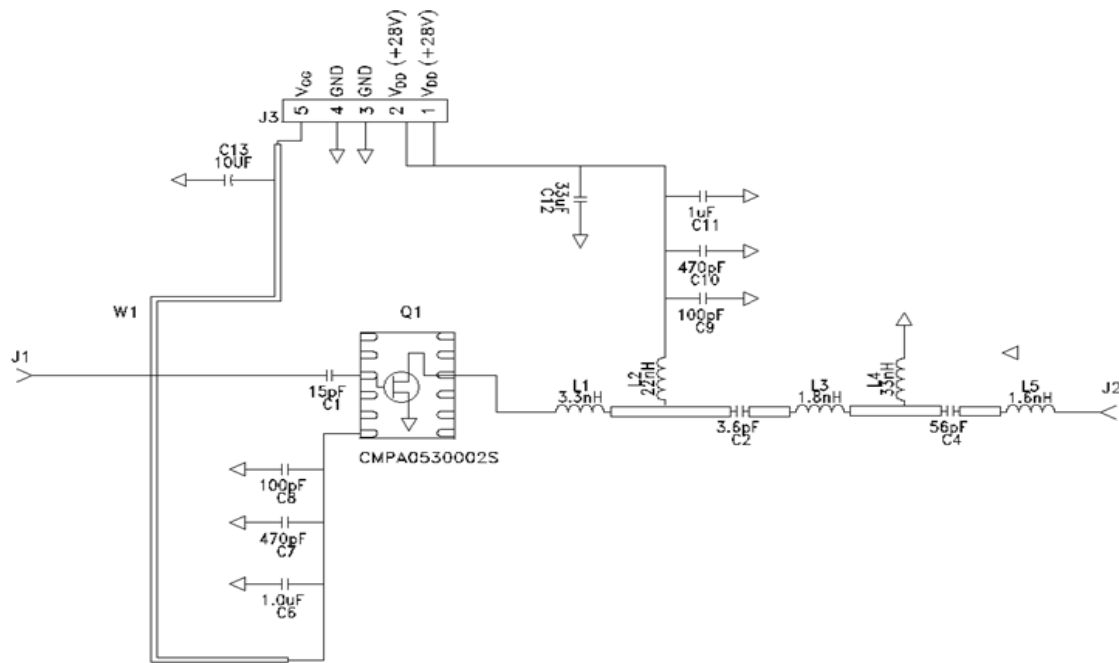

CMPA0530002S-AMP1 Application Circuit Outline

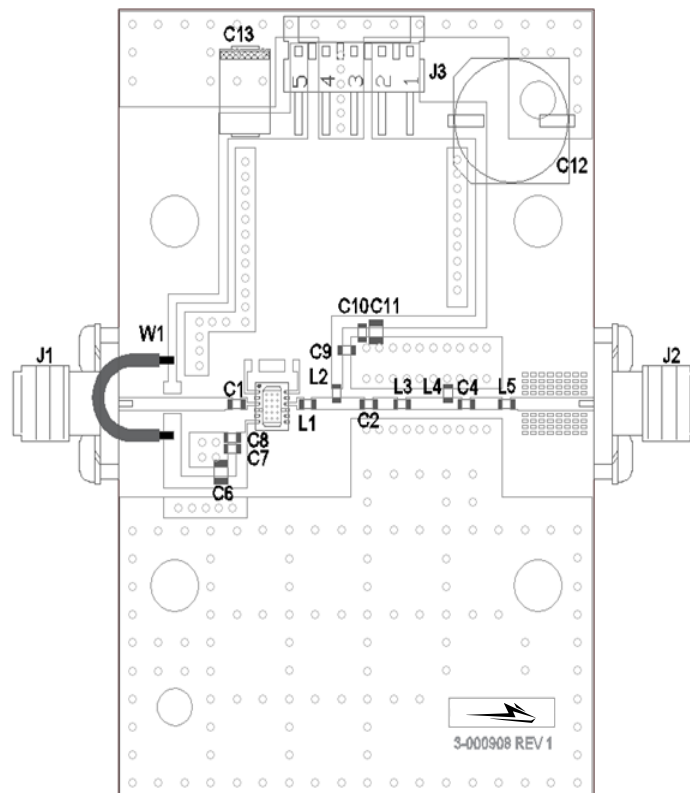



CMPA0530002S Power Dissipation De-rating Curve

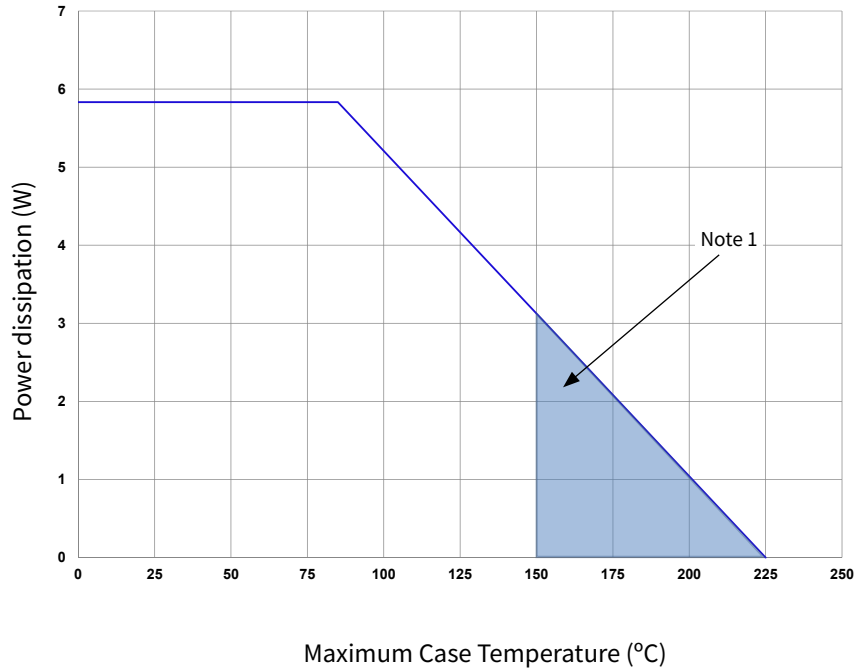

Note 1. Area exceeds Maximum Case Temperature (See Page 2)

Electrostatic Discharge (ESD) Classifications

Parameter	Symbol	Class	Classification Level	Test Methodology
Human Body Model	HBM	1A	ANSI/ESDA/JEDEC JS-001 Table 3	JEDEC JESD22 A114-D
Charge Device Model	CDM	C2B	ANSI/ESDA/JEDEC JS-002 Table 3	JEDEC JESD22 C101-C

Moisture Sensitivity Level (MSL) Classification

Parameter	Symbol	Class	Test Methodology
Moisture Sensitivity Level	MSL	3 (168 hours)	IPC/JEDEC J-STD-20



Source and Load Impedances

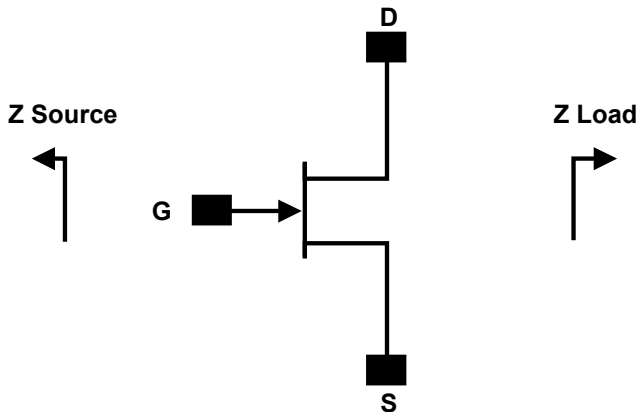

Frequency (GHz)	Z Source	Z Load
0.5	49.81 - j4.94	120.85 + j24.29
1.0	50.23 - j0.76	65.28 + j15.87
1.5	50.75 + j1.20	70.37 + j20.78
2.0	51.36 + j2.49	62.60 + j23.33
2.5	52.58 + j3.98	51.31 + j44.84
3.0	51.68 + j2.92	60.64 + j75.97

Notes:

¹ $V_{DD} = 28V, I_{DQ} = 90mA$

² Impedances are extracted from source and load pull data derived from the transistor



Product Dimensions CMPA0530002S (Package 3 x 4 DFN)

SYMBOL	COMMON DIMENSIONS			NOTE
	MIN.	NOM.	MAX.	
A	0.80	0.90	1.0	
A1	0.00	0.02	0.05	
A3	0.203 REF.			
Ø	0	—	12	2
D	4.00 BSC			
E	3.00 BSC			
Ⓢ	0.50 BSC			
N	12			3
ND	6			△
L	0.35	0.40	0.45	
b	0.18	0.25	0.30	△
D2	3.20	3.30	3.40	
E2	1.60	1.7	1.80	
K	0.20	—	—	

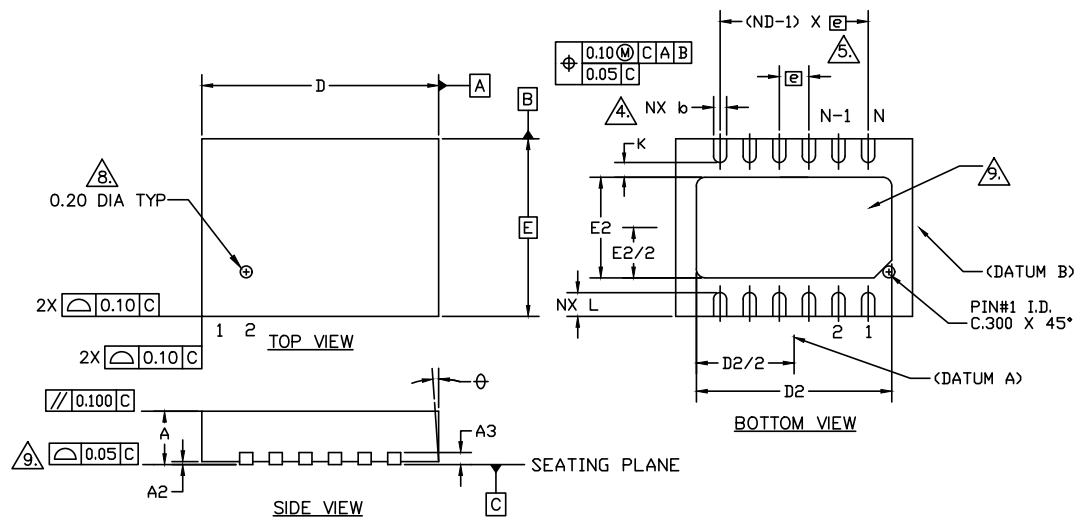

Pin	Input/Output
1	NC
2	NC
3	RF IN
4	GND
5	NC
6	V _G
7	NC
8	NC
9	GND
10	RF OUT & V _{DD}
11	NC
12	NC

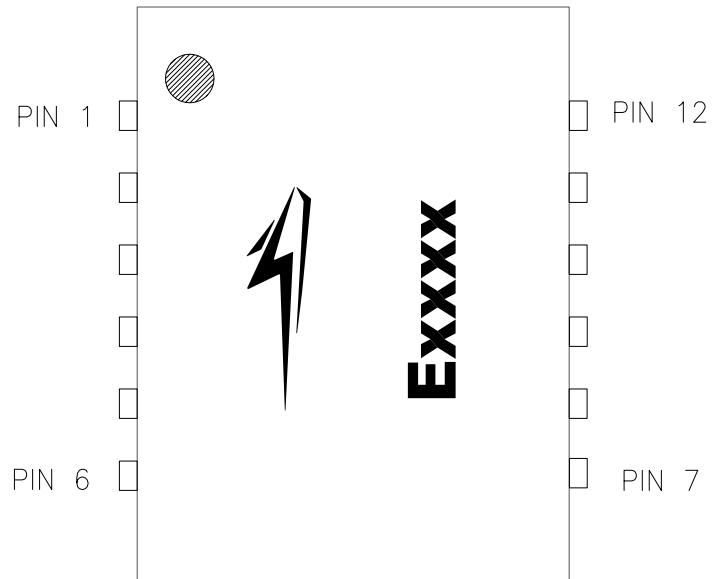

Note: Leadframe finish for 3x4 DFN package is Nickel/Palladium/Gold. Gold is the outer layer



Part Number System

CMPA0530002S

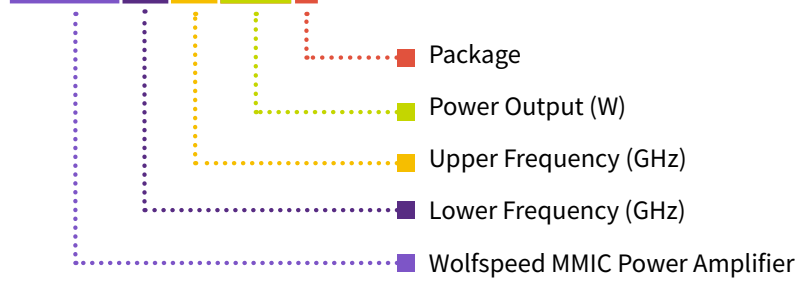

Table 1.

Parameter	Value	Units
Upper Frequency ¹	3.0	GHz
Power Output	2	W
Package	Surface Mount	—

Note:

¹ Alpha characters used in frequency code indicate a value greater than 9.9 GHz. See Table 2 for value.

Table 2.

Character Code	Code Value
A	0
B	1
C	2
D	3
E	4
F	5
G	6
H	7
J	8
K	9
Examples	1A = 10.0 GHz 2H = 27.0 GHz

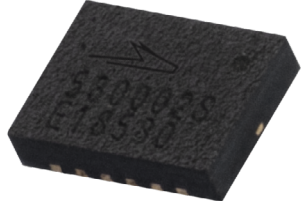
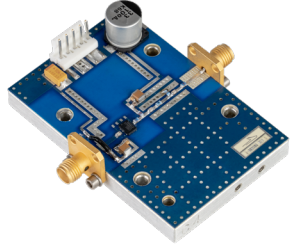

Product Ordering Information

Order Number	Description	Unit of Measure	Image
CMPA0530002S	GaN HEMT	Each	 A small, dark, rectangular component with a white arrow pointing to the right and the text 'E338' embossed on its top surface.
CMPA0530002S-AMP1	Test board with GaN MMIC installed	Each	 A blue printed circuit board (PCB) populated with various electronic components, including a silver cylindrical component, several surface-mount components, and two gold SMA connectors.

**For more information, please contact:**

4600 Silicon Drive
Durham, NC 27703 USA
Tel: +1.919.313.5300
www.wolfspeed.com/RF

Sales Contact
RFSales@wolfspeed.com

RF Product Marketing Contact
RFMarketing@wolfspeed.com

Notes & Disclaimer

Specifications are subject to change without notice. “Typical” parameters are the average values expected by Wolfspeed in large quantities and are provided for information purposes only. Wolfspeed products are not warranted or authorized for use as critical components in medical, life-saving, or life-sustaining applications, or other applications where a failure would reasonably be expected to cause severe personal injury or death. No responsibility is assumed by Wolfspeed for any infringement of patents or other rights of third parties which may result from use of the information contained herein. No license is granted by implication or otherwise under any patent or patent rights of Wolfspeed.

©2020-2022 Wolfspeed, Inc. All rights reserved. Wolfspeed® and the Wolfstreak logo are registered trademarks and the Wolfspeed logo is a trademark of Wolfspeed, Inc.
PATENT: <https://www.wolfspeed.com/legal/patents>

The information in this document is subject to change without notice.