



Main

Range of Product	Telemecanique Cabling components
Accessory / separate part category	Cabling accessory
Accessory / Separate Part Type	Pre-wired connectors
Series name	General purpose

Complementary

Electrical connection	Elbowed female connector Ø 8 mm, 3 pins
Cable connector fixing	Clip-on
Status LED	Without
Cable length	6.56 ft (2 m)
Cable outer diameter	0.20 in (5.2 mm)
Cable composition	3 x 0.34 mm ²
Wire insulation material	PUR
[Ue] rated operational voltage	60 V AC 75 V DC
Line Rated Current	4 A
Contact resistance	5000 µOhm
Minimum insulating resistance	1 GΩ
Net Weight	0.11 lb(US) (0.05 kg)

Environment

IP Degree of Protection	IP65 IP67
Product Certifications	cULus
Ambient air temperature for operation	-40...176 °F (-40...80 °C) static 23...176 °F (-5...80 °C) flexing
Ambient Air Temperature for Storage	-40...176 °F (-40...80 °C)

Ordering and shipping details

Category	22483-MACHINE CABLES
Discount Schedule	DS3
GTIN	3389110762983
Nbr. of units in pkg.	1
Package weight(Lbs)	1.98 oz (56.0 g)
Returnability	No
Country of origin	CZ

Packing Units

Unit Type of Package 1	PCE
Package 1 Height	0.39 in (1 cm)
Package 1 width	5.51 in (14 cm)
Package 1 Length	5.51 in (14 cm)
Unit Type of Package 2	S02
Number of Units in Package 2	40
Package 2 Weight	5.66 lb(US) (2.566 kg)
Package 2 Height	5.91 in (15 cm)
Package 2 width	11.81 in (30 cm)
Package 2 Length	15.75 in (40 cm)

Offer Sustainability

Sustainable offer status	Green Premium product
California proposition 65	WARNING: This product can expose you to chemicals including: Diisononyl phthalate (DINP), which is known to the State of California to cause cancer, and Di-isodecyl phthalate (DIDP), which is known to the State of California to cause birth defects or other reproductive harm. For more information go to www.P65Warnings.ca.gov
REACH Regulation	REACH Declaration
EU RoHS Directive	Pro-active compliance (Product out of EU RoHS legal scope) EU RoHS Declaration
Mercury free	Yes
RoHS exemption information	Yes
Environmental Disclosure	Product Environmental Profile
Circularity Profile	End Of Life Information

Contractual warranty

Warranty	18 months
----------	-----------

Dimensions

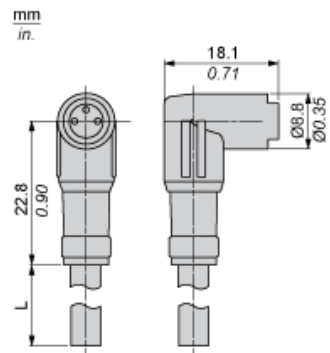

L : Length of cable

Connections and Schemes

Connector

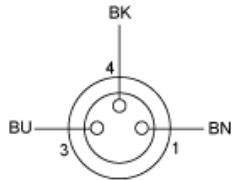

BU : Blue
BN : Brown
BK : Black