

General Description

The MAX77301 evaluation kit (EV kit) is a fully assembled and tested PCB for evaluating the MAX77301 dual-path lithium-ion (Li+) battery charger with USB enumeration and automatic adapter-type detection features. The EV kit is powered from a USB port or dedicated charger with automatic detection of adapter type and USB enumeration capability.

The IC features a Smart Power Selector™ feature that makes the best use of limited USB or adapter power. Battery charge current is set independent of the input-current limit. Power not used by the system charges the battery. This allows the application to operate without a battery, discharged battery, or dead battery. Automatic input selection switches the system between battery, battery assist, and external power modes.

The EV kit provides LED indicators for adapter-type detection (\overline{UOK}), external power-on ($\overline{EXT_PWRON}$), charging status ($\overline{CHG_STAT}$), external power-source current capability ($\overline{CHG_TYPE}$), and interrupts (\overline{IRQ}). The EV kit also features an NTC thermistor for thermal protection and JEITA-compliant* charging.

The EV kit is configured for full-speed USB by default, but can be configured for low-speed USB by removing the crystal oscillator and adjusting jumper default settings (see [Table 1](#)).

Benefits and Features

- Enables Charging from a Micro-B USB Connector
- USB Enumeration without Host-Processor Intervention
- Automatic Detection of Adapter Type or USB Port
- Dual-Speed USB Operation (Full Speed or Low Speed)
- Input Overvoltage Protection to 16V
- Smart Power Selector
 - Automatic Current Sharing Between Battery Charging and System
 - Operates with Discharged or No Battery
- LED Indicators
- NTC Monitoring of Battery Temperature
- JEITA-Compliant Charging Profile
- Thermal-Charge Regulation Prevents the IC from Overheating

[Ordering Information](#) appears at end of data sheet.

Smart Power Selector is a trademark of Maxim Integrated Products, Inc.

**U.S. Patent # 6,507,172.*

Quick Start

Recommended Equipment

- MAX77301 EV kit test fixture
- USB A-to-USB micro-B cable (supplied with the EV kit)
- User-supplied PC with a spare USB port
- I2C command module (CMAXQUSB or MINIQUSB) (USB cable included)
- Four digital multimeters with current-measurement capability (DMM1–DMM4)
- BAT electronic load (constant voltage (CV), able to sink current) or Li+ battery
- SYS electronic load
- MAX77301 software (GUI)

Note: In the following sections, software-related items are identified by bolding. Text in **bold** refers to items directly from the EV system software. Text in **bold and underlined** refers to items from the Windows operating system.

Procedure

The EV kit is a fully assembled and tested surface-mount board. Follow the steps below and [Figure 9](#) to set up and verify the IC and board operation:

- 1) Verify that the jumpers on the EV kit are properly configured, as shown in [Table 1](#).
- 2) Visit www.maximintegrated.com/evkitsoftware to download the latest version of the EV kit software. Save the EV kit software to a temporary folder and uncompress the ZIP file. The CMAXQUSB or MINIQUSB firmware can also be found at the

same link. The EV kit is compatible with both the CMAXQUSB and MINIQUSB interface boards.

- 3) Install the EV kit software and USB interface firmware inside the temporary folder on your PC by running the .EXE program.
- 4) Connect the USB cable from the PC to the CMAXQUSB/MINIUSB interface board. A **Building Driver Database** window pops up in addition to a **New Hardware Found** message when installing the USB driver for the first time. If you do not see a window that is similar to the one described above after 30s, remove the USB cable from the board and reconnect it. Administrator privileges are required to install the USB device driver on Windows®.
- 5) Follow the directions of the **Add New Hardware Wizard** to install the USB device driver. Choose the **Search for the best driver for your device** option. Specify the location of the device driver (default installation directory) using the **Browse** button. During device driver installation, Windows may show a warning message indicating that the device driver that Maxim uses does not contain a digital signature. This is not an error condition and it is safe to proceed with installation. Refer to the USB_Driver_Help.PDF document for additional information.
- 6) If using the CMAXQUSB command module, ensure that the shunt on jumper JU1 is in the 3.3V position.
- 7) Carefully connect the boards by aligning the 20-pin connector on the EV kit with the 20-pin header on the CMAXQUSB/MINIUSB interface board. Gently press them together.

Table 1. Default Jumper Settings (JU1–JU10)

JUMPER	SHUNT POSITION	FUNCTION
JU1	PCB short	Connects XOUT to the Y1 crystal.
JU2	PCB short	Connects XIN to the Y1 crystal.
JU3	PCB open	Connects XOUT to INT_3V3.
JU4	1-3	Selects BUS, SYS, or V _{DD} as the LED indicator power source.
JU5	PCB short	Shorts DGND and AGND together. Do not disconnect.
JU6	1-2	Selects the logic level for $\overline{\text{ENU_EN_HW}}$.
JU7	1-2	Selects the logic level for STDB_EN_HW.
JU8	1-2	Selects the logic level for CEN.
JU9	1-2	Selects the logic level for IBUS_DEF.
JU10	PCB open	Connects XIN to AGND.

Windows is a registered trademark and registered service mark of Microsoft Corporation.

- 8) If simulating a battery, set the BAT electronic load to 3.6V at CV mode and turn off.
- 9) Observe correct polarity. Connect the BAT electronic load/Li+ battery and series digital multimeter (DMM4) in the current-measurement mode, as shown in [Figure 9](#). Leave the BAT electronic load turned off. If using an Li+ battery, leave the positive terminal unconnected.
- 10) Connect DMM1 across the BAT electronic load/Li+ battery. Connect the positive terminal of DMM1 to the positive terminal of the Li+ battery. Connect the negative terminal of DMM1 to the negative terminal of the Li+ battery.
- 11) Connect DMM2 from INT_3V3 to BUS_DGND.
- 12) Connect DMM3 from SYS to SYS_DGND.
- 13) Preset the SYS electronic load for 100mA and turn off.
- 14) Connect the SYS electronic load from SYS to SYS_GND.
- 15) Plug a USB cable from P1 to the PC with a 500mA USB cable.
- 16) Verify that the LED at D1 is on, indicating that a dedicated charger has been detected.
- 17) Start the EV kit software.
- 18) Select the **Device** menu item in the upper-left corner, then **Connect**. Wait for the device to respond, and in the **Synchronize** window, press the **Read and Close** button. Normal device operation is verified when **Connected** is displayed in bottom-left corner.
Note: All default EV kit software settings are used for the remainder of the test procedure.
- 19) Turn on the BAT electronic load or connect the positive terminal of the Li+ battery to V_{BAT+} .
Note: When using an Li+ battery, if $V_{BAT+} < 2.5V$, the charger starts up in precharge mode. If $V_{BAT+} \geq 2.5V$, the charger starts up in fast-charge mode. If in precharge mode, verify that DMM4 reads 50mA. If in fast-charge mode, verify that DMM4 reads 200mA.
- 20) Verify that $\overline{CHG_STAT}$ (the LED at D4) is on, indicating that charging is occurring.
- 21) Verify that the voltage read by DMM2 is approximately 3.3V.
- 22) Verify that the voltage read by DMM3 is (DMM1 + 140mV) or 4.3V, whichever is greater.

- 23) Turn on the SYS electronic load and verify that the voltage read by DMM3 is (DMM1 + 140mV) or 4.3V, whichever is greater.
- 24) Disconnect the BAT electronic load/Li+ battery and wait until DMM1 reads 4.2V, indicating a fully charged battery.
- 25) Verify that the voltage read by DMM3 is the greater of (DMM1 + 140mV) or 4.35V.
- 26) Turn off the SYS electronic load.
- 27) Remove the USB cable from P1.
- 28) Disconnect all test leads from the EV kit.

Detailed Description of Hardware

The MAX77301 EV kit evaluates the MAX77301 integrated 1-cell Li+ charger with USB enumeration and adapter-type detection capability. The EV kit negotiates charging current from the USB host or hub, without processor intervention. The IC also automatically detects for a dedicated charger, USB charger, or adapter and sets the input-current limit accordingly. The USB input power not used by the system charges the battery.

USB Interface

An integrated USB peripheral controller provides autoenumeration for full-speed and low-speed modes. The USB controller is in charge of:

- Executing adapter-detection sequence: Detects what type of adapter is externally connected to the USB receptacle (P1) and sets the input-current limit accordingly.

If the USB receptacle (P1) is attached to a USB charger (host or hub) or a USB 2.0 (host or hub), it enumerates as an HID device and negotiates the maximum charging current level (from BUS).

The IC operates in low-speed mode using an internal 6MHz oscillator and does not require an external crystal to be USB compliant. The IC operates in full-speed mode and requires an external 12MHz crystal (Y1, [Figure 9](#)).

According to the USB 2.0 specification, a low-speed device is not allowed to use a standard USB type-B connector, which is why the IC is also able to operate in full-speed mode. This makes it possible to use a custom or captive cable for low-speed mode using the IC and still be USB compliant. While operating in full-speed mode, using the IC allows use of a standard USB type-B connector.

Adapter Detection

When an adapter is present on the USB receptacle (P1), the IC examines the external device to identify the type of adapter connected. The possible adapter types are:

- Dedicated charger
- USB charger (host or hub)
- USB 2.0 low power (host or hub)
- USB 2.0 high power (host or hub)

Each of these different devices has different current capability, as shown in [Table 2](#).

When an adapter is connected, the IC performs a series of tests to identify the type of device connected. Refer to the flow charts in the MAX77301 IC data sheet for more details.

Smart Power Selector

The Smart Power Selector seamlessly distributes power between the external adapter input (BUS), the battery (BAT+), and the system load (SYS). The Smart Power Selector basic functions are:

- 1) With both an external adapter and battery connected:
 - a) When the system load requirements are less than the input-current limit, the battery is charged with residual power from the input.
 - b) When the system load requirements exceed the input-current limit, the battery supplies supplemental current to the load.

- 2) With the battery connected and no external power input, the system is powered from the battery.
- 3) With an external power input connected and no battery, the system is powered from BUS.

If the junction temperature starts to get too hot (110°C, typ), the charging rate is reduced. If this is insufficient to cool down the IC, the input-current limit is then reduced.

SYS Regulation Voltage

The IC always regulates SYS to 140mV (typ) above BAT+, with a minimum voltage programmable from 3.4V to 4.5V, regardless of what device is connected. The 3.4V minimum voltage regulation reduces the ripple on SYS during peak load conditions where the input-current limit is tripped.

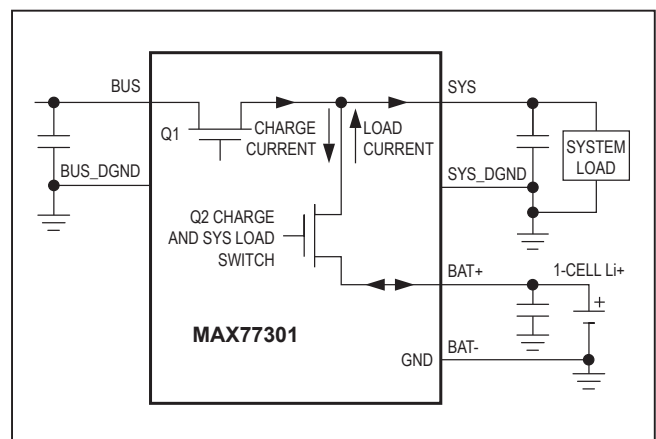

Figure 1. Smart Power Selector

Table 2. Adapter Types

ADAPTER TYPE	OUTPUT VOLTAGE	OUTPUT CURRENT
Dedicated charger	4.75V to 5.25V at $I_{LOAD} < 500mA$; 2.0V to 5.25V for $I_{LOAD} \geq 500mA$	500mA to 1.8A
Charger downstream port	4.75V to 5.25V at $I_{LOAD} < 500mA$; 2.0V to 5.25V for $I_{LOAD} \geq 500mA$	500mA to 900mA for low-speed and full-speed operation; 500mA to 1.5A for low-speed and full-speed operation
Apple 500mA	4.75V to 5.25V at $I_{LOAD} < 500mA$	500mA (max)
Apple 1A	4.75V to 5.25V at $I_{LOAD} < 1A$	1A (max)
Apple 2A	4.75V to 5.25V at $I_{LOAD} < 2A$	2A (max)
Sony 500mA	4.75V to 5.25V at $I_{LOAD} < 500mA$	500mA (max)
Sony 500mA type B	4.75V to 5.25V at $I_{LOAD} < 500mA$	500mA (max)
USB 2.0 low power	4.25V to 5.25V	100mA (max)
USB 2.0 high power	4.75V to 5.25V	500mA (max)

LED Indicators

UOK Status Output

UOK is an open-drain output that is pulled low when the BUS input is inserted and adapter-type detection is complete. In USB suspend mode, the UOK pin flashes with a duty cycle of 50% for a duration of 1.5s. When D+/D- open is detected and bit nENU_EN = 1, UOK flashes with a duty cycle of 50% for a duration of 0.15s. UOK is in high impedance if no adapter is detected. The input UVLO/OVLO thresholds must be met prior to adapter detect and UOK pin response. The UVLO/OVLO thresholds are shown in [Table 3](#).

CHG_TYPE Status Output

CHG_TYPE is an open-drain output that indicates the type and current limit of the external power supply. The pin is pulled low to indicate a 100mA USB 2.0 host with device input-current limit (ILIM) ≤ 100mA. CHG_TYPE is high impedance when the device input-current limit (ILIM) is ≥ 500mA.

EXT_PWRON Output

EXT_PWRON is an active-low, open-drain output that is pulled low after a valid external power supply is present. If a valid power supply is not present, EXT_PWRON is in high impedance.

The EXT_PWRON output can be connected to an external device that controls power to external circuits, such as an external p-channel MOSFET. If a valid adapter is connected to the system while the battery is below the VBAT_UVLO threshold, EXT_PWRON transitions from high impedance to low when the adapter type is determined and UOK transitions from high to low impedance.

Charge Status Output (CHG_STAT)

CHG_STAT is an active-low, open-drain output indicating state-of-battery charging. A temperature or timer fault changes the charge state of the CHG_STAT pin. See [Table 4](#) for CHG_STAT behaviors.

Interrupt Request Output (IRQ)

IRQ is an active-low, open-drain output that is pulled low when an interrupt occurs. If an interrupt has occurred, the event and status information is available in the EVENT_ and STATUS_ registers. Interrupts indicate temperature and voltages as well as charge and timer fault conditions. Events are triggered by a state change in the associated register. The event registers are reset to the default condition when read by the I2C interface. When the EVENT_ registers are read in page mode, the IRQ is not released until the last bit has been read. New interrupt events are held until a complete read of all registers has occurred.

The interrupt mask bits located in register 0x07 disable the output pin, maintaining a high-impedance state.

Table 3. UVLO/OVLO Thresholds

FOR	UVLO	OVLO
Initial BUS detection	4.0V (typ) rising	6.9V (typ) (V _{BUS} rising)
USB 2.0 low power	3.9V (typ) falling	
USB 2.0 high power, or when ILIM is not set to 111	4.1V (typ) falling	
Adaptive (when ILIM is set to 111)	V _{SYS} + 50mV (typ) falling	

Table 4. CHG_STAT Indications

CHARGER STATUS	CHG_STAT BEHAVIOR
Charge in progress, low (continuous)	Charge in progress, low (continuous)
Charge suspend (due to temperature faults) pulses with 1.5s duration and 50% duty cycle	Charge suspend (due to temperature faults) pulses with 1.5s duration and 50% duty cycle
Charge suspend (due to temperature faults) pulses with 1.5s duration and 50% duty cycle	Charge suspend (due to temperature faults) pulses with 1.5s duration and 50% duty cycle
Timer fault pulses with 0.15s duration and 50% duty cycle	Timer fault pulses with 0.15s duration and 50% duty cycle
Charge done, high impedance	Charge done, high impedance
Battery removed pulses with 0.1s duration	10% to 20% duty cycle

Thermistor Input (THM)

The THM input connects to an external negative temperature coefficient (NTC) thermistor to monitor battery or system temperature and bias resistor. The bias resistor is connected to the INT_3V3 output pin. Charging is suspended when the thermistor temperature is out of range. The charge timers are suspended and hold their state, but no fault is indicated. When the thermistor comes back into range, charging resumes and the charge timer continues from where it was previously. Connect THM to AGND to disable the thermistor monitoring function. For more details refer to the MAX77301 IC data sheet.

JEITA Compliance

V_{THM} is monitored to provide battery temperature information to the charge controller. The JEITA temperature profiles shown in Figure 2 utilize a 47kΩ bias resistor between the INT_3V3 and THM pins. The thermistor is a 100kΩ NTC-type beta of 4250K, which is connected from NTC to ground.

The IC is compliant with the JEITA specification for safe use of secondary Li+ batteries (*A Guide to the Safe Use of Secondary Lithium Ion Batteries in Notebook type Personal Computers*, JEITA and Battery Association of Japan, April 20, 2007). Once the JEITA parameters have been initialized for a given system, no software interaction is required. The four temperature thresholds change the battery-charger operation (T1–T4). When the thermistor input exceeds the intermediate threshold (< T2 or > T3), the end-of-charge voltage is reduced. When the thermistor input exceeds the extreme temperatures (< T1 or > T4), the charger shuts off and all respective charging timers are suspended. While the thermistor remains out of range, no charging occurs, and

the timer counters hold their state. When the thermistor input comes back into range, the charge timers continue to count. The middle thresholds (T2 and T3) do not shut the charger off, but have the capability to adjust the current/voltage targets to maximize charging while reducing battery stress.

The behavior when the battery temperature is between T1 and T2 is controlled by THM_T1_T2 and the behavior when it is between T3 and T4 is controlled by THM_T3_T4.

The JEITA specification recommends that systems reduce all loading on the battery when the battery temperature exceeds the maximum battery temperature for discharge (TMD). The IC generates an interrupt and sets the WHIGH_BAT_T_IRQ bit when the battery temperature exceeds the T4 threshold.

If the THM disable threshold is exceeded, an interrupt is generated and the BAT_DET_IRQ bit is cleared in the event register.

If the thermistor functionality is not required, clearing the THERM_EN disables temperature sensing and the thermistor input is then high impedance.

The IC is compatible with a 100kΩ thermistor with a beta of 4250K. The general relation of thermistor resistance to temperature is defined by the following equation:

$$R_T = R_{25} \times e^{\left\{ \beta \left(\frac{1}{T+273} - \frac{1}{298} \right) \right\}}$$

where R_T is the resistance in Ω of the thermistor at temperature T in Celsius, R₂₅ is the resistance in Ω of the thermistor at +25°C, β is the material constant of the thermistor (typically ranges from 3000K to 5000K), and T is the temperature of the thermistor in °C.

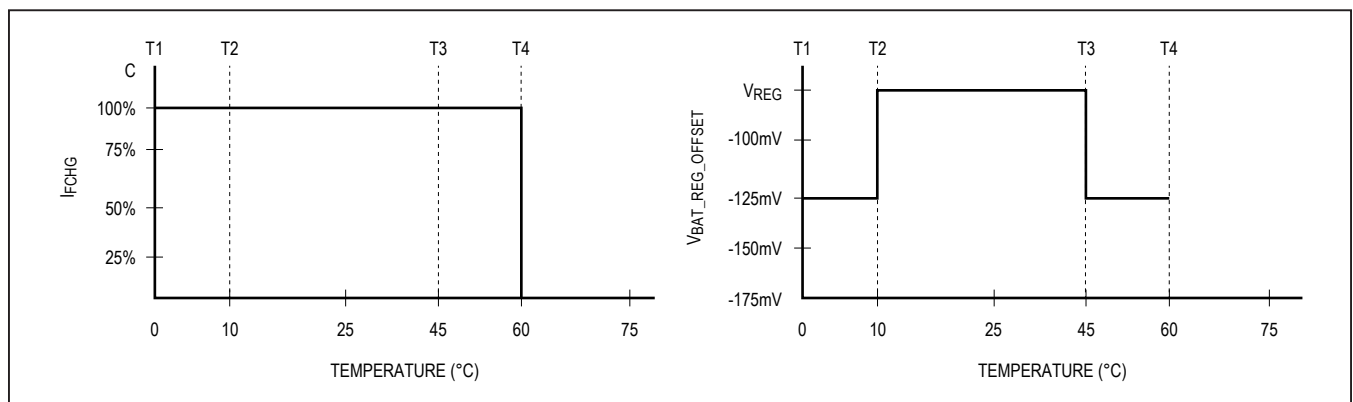

Figure 2. JEITA Battery Safety Regions

Thermal Shutdown

Thermal shutdown limits total power dissipation in the IC. When the junction temperature exceeds +160°C (typ), the device turns off, allowing the IC to cool.

External Crystal/Ceramic Resonator

XIN and XOUT are used to interface to an external 12MHz crystal (Y1). The Y1 crystal included in the EV kit includes internal load capacitors; therefore, C5 and C6 are not loaded. If another crystal is selected, consult the crystal manufacturer's data sheet for load capacitances if needed. The crystal (Y1) and optional capacitors (C5, C6) can be removed for USB low-speed operation.

External Clock

The IC accepts an external clock input at XIN. Remove the preinstalled crystal (Y1, [Figure 9](#)) before driving an external clock signal to XIN. The external clock can either be a digital level square wave or sinusoidal and this can be directly coupled to XIN without the need for additional components. If the peaks of the reference clock are above V_{INT_3V3} or below ground, the clock signal must be driven through a DC-blocking capacitor (~33pF) connected to XIN.

The external clock source can be enabled using the \overline{UOK} or INT_3V3 signals, depending on whether the clock source is active-low or active-high enabled.

If the INT_3V3 rail is used, ensure that no significant load is taken from this output since this affects the performance of the IC. Because the INT_3V3 LDO's input is sourced from V_{BUS} , significant loading could also cause violation of the USB specifications.

Evaluating USB Low-Speed Operation

The following EV kit modification is required for USB low-speed operation:

- 1) Cut the PCB traces between the two half circles on jumpers JU1 and JU2.
- 2) Solder the two half circles together on jumper JU3.
- 3) Install a jumper at JU10.

Evaluating USB Full-Speed Operation

To evaluate the USB full-speed operation, use default EV kit connections and verify the following:

- 1) PCB traces or short circuit between the two half circles on jumpers JU1 and JU2.
- 2) The two half circles at jumper JU3 are open and the JU10 jumper is removed.

The EV kit is preinstalled with the Murata CSTCE12M0G15L crystal, which contains internal load capacitors. Install C5 and C6 if an alternate crystal is desired that does not contain internal load capacitors.

Graphic User Interface (GUI) Description

The EV kit provides an I²C-compatible, 2-wire serial interface that controls the charger settings as well as read back of adapter detection. [Figure 3](#) shows the GUI window upon a successful connection to the EV kit and its ID information. [Figure 4](#), [Figure 5](#), and [Figure 6](#) show the charger's main, control, and settings windows, while [Figure 7](#) and [Figure 8](#) show the status and interrupts windows respectively. Refer to the IC data sheet for a complete description of the registers.

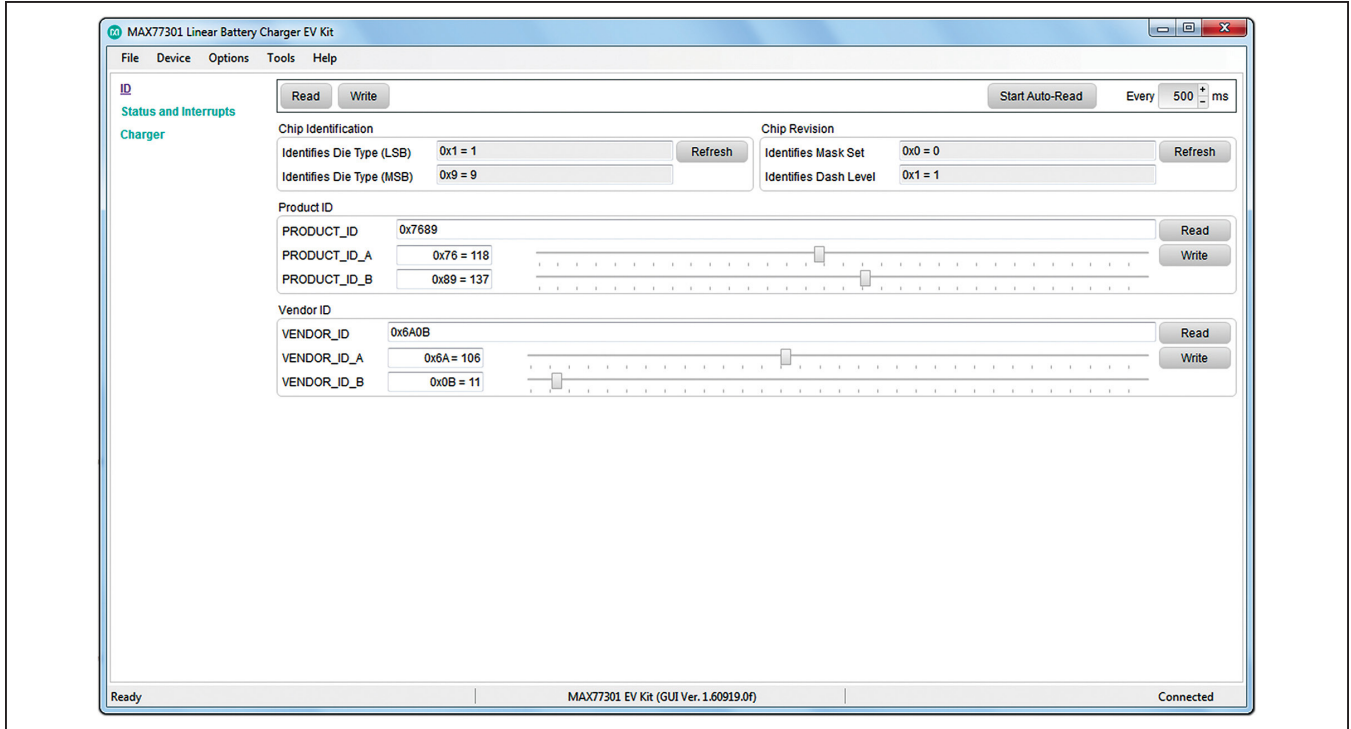

Figure 3. GUI Top-Level Interface

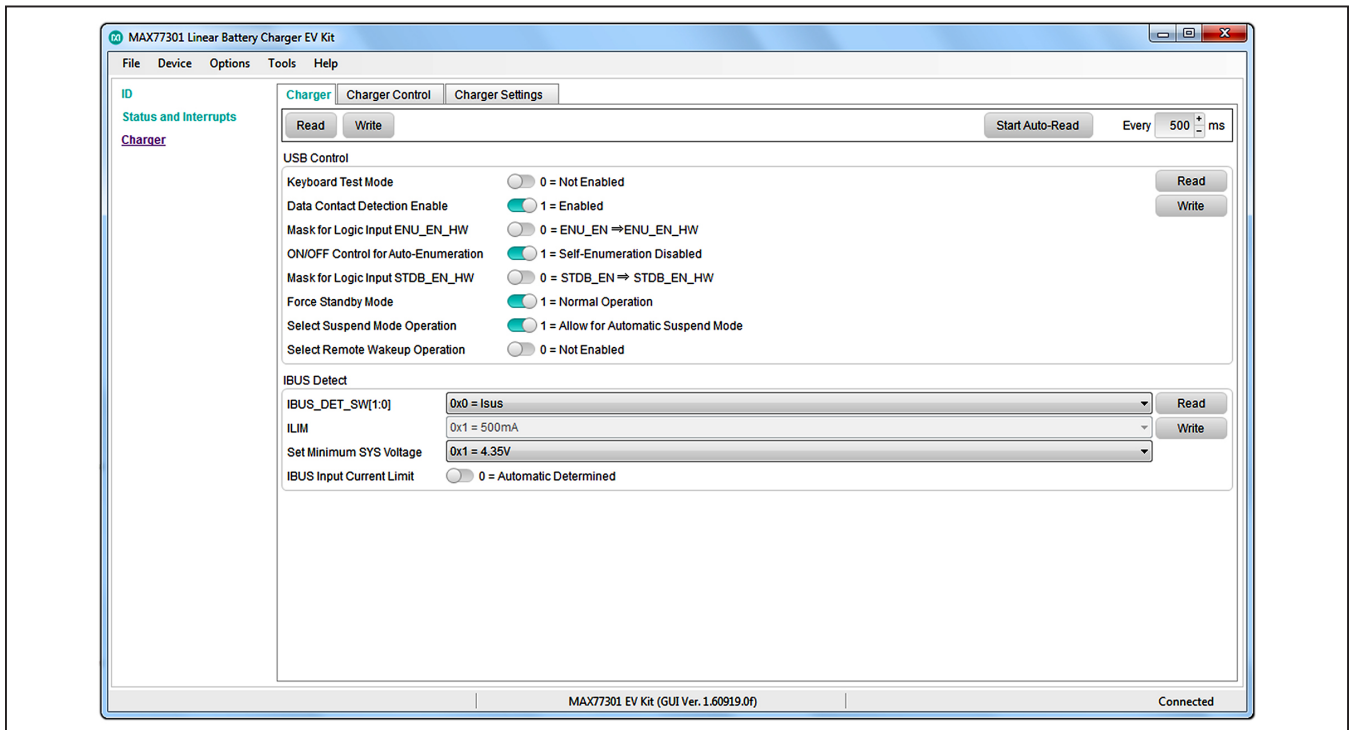

Figure 4. Charger Main Window

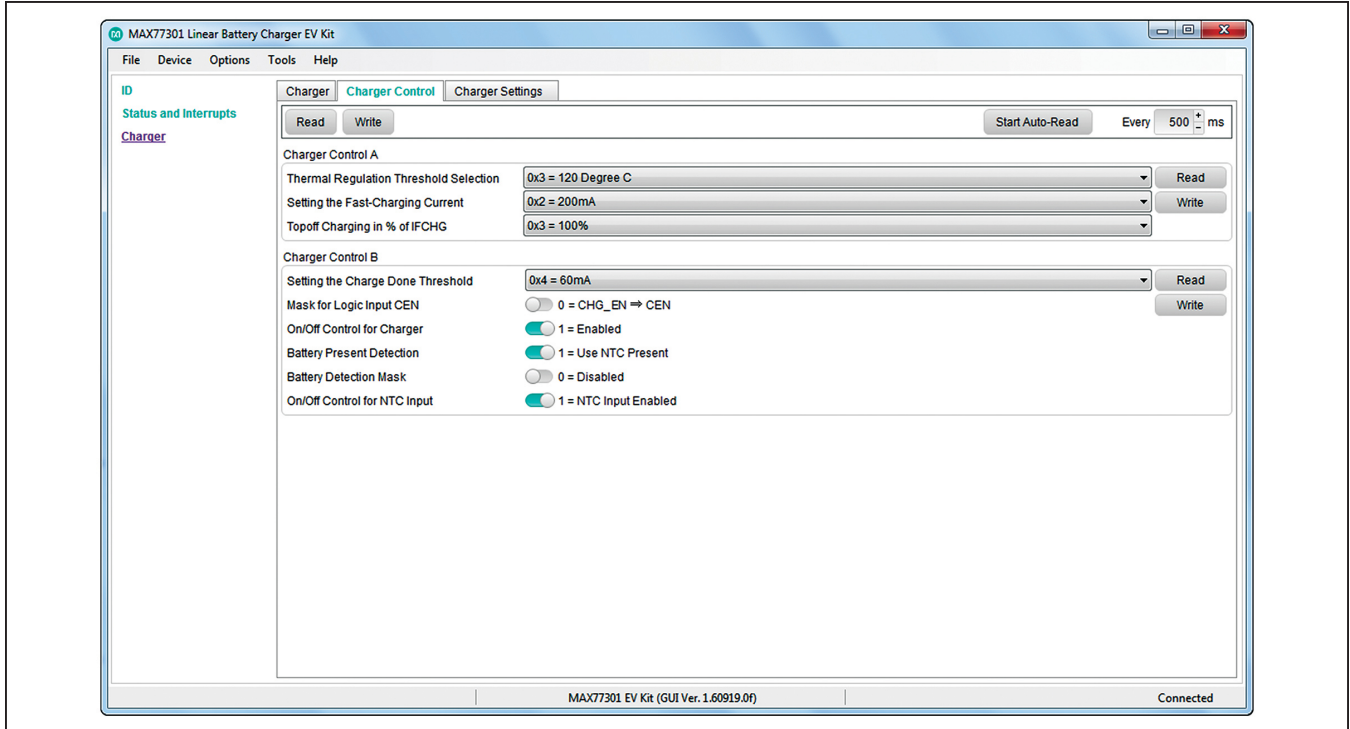

Figure 5. Charger Control Window

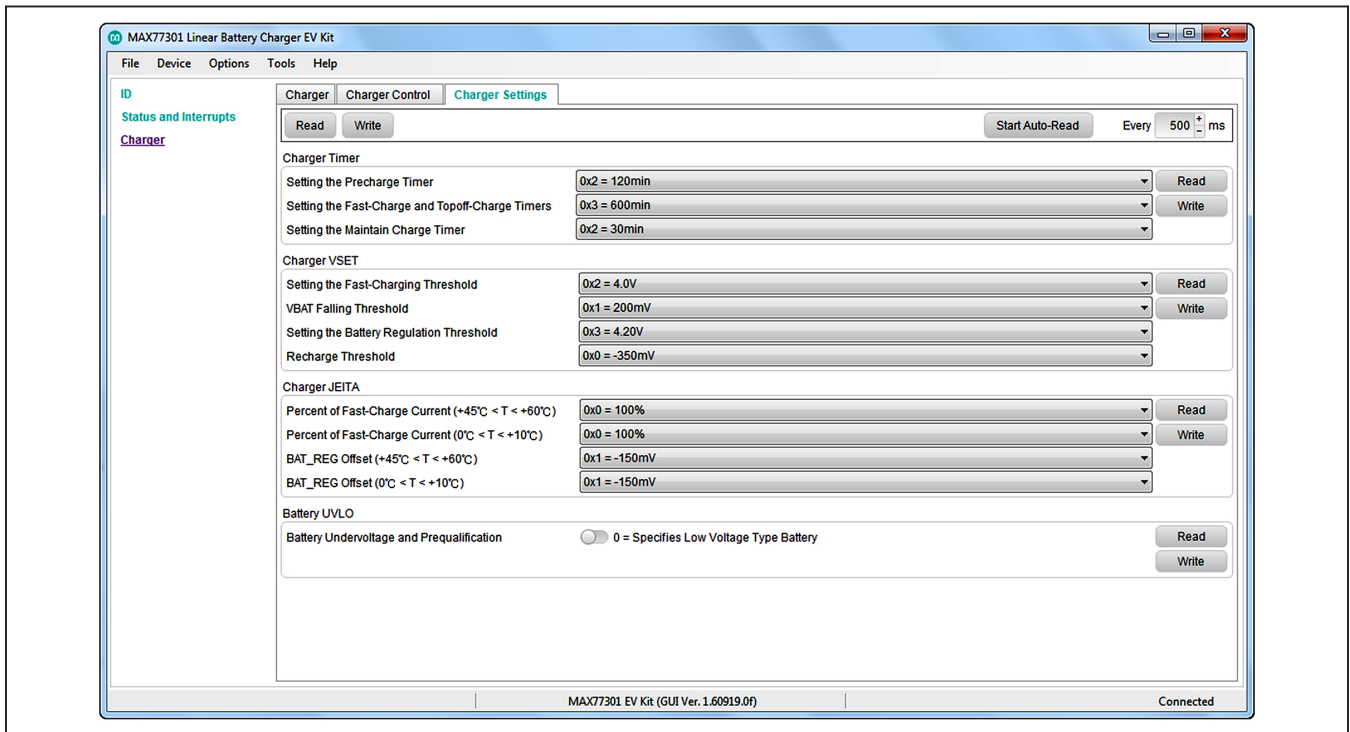

Figure 6. Charger Settings Window

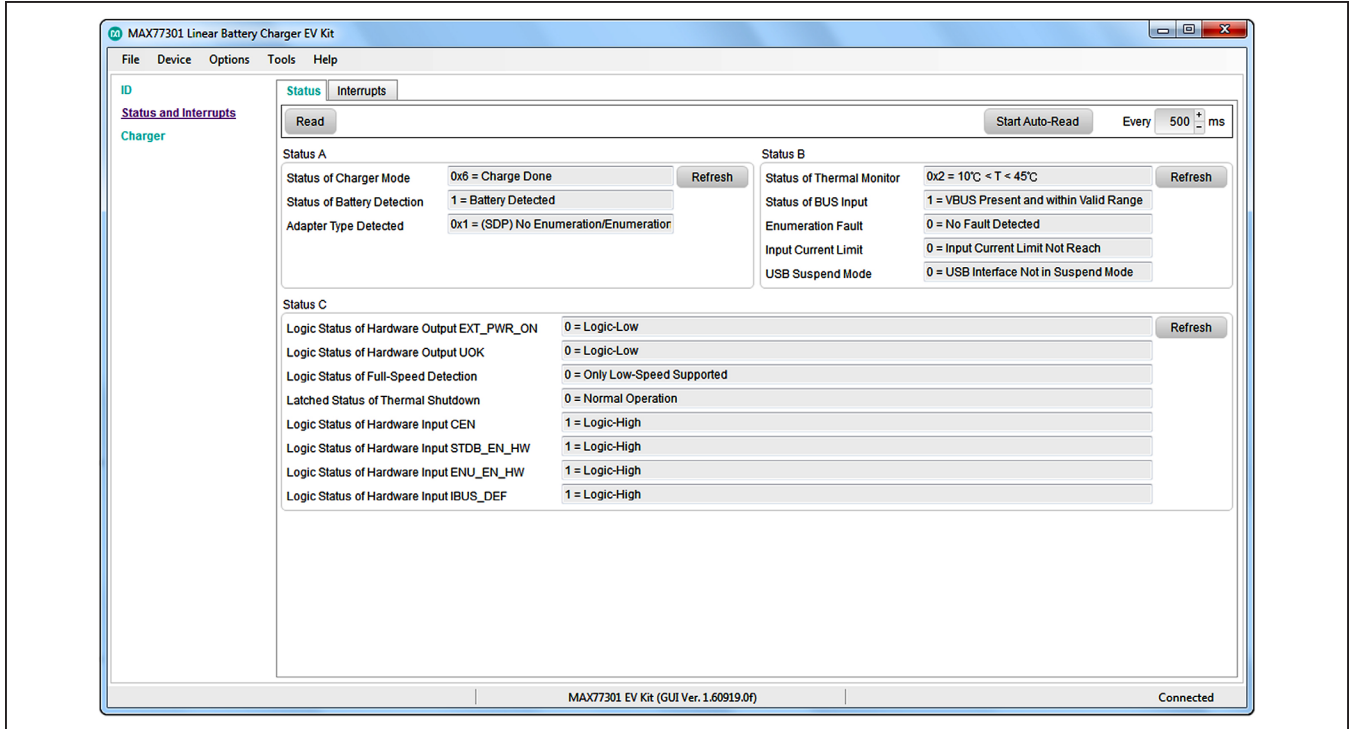

Figure 7. Status Window

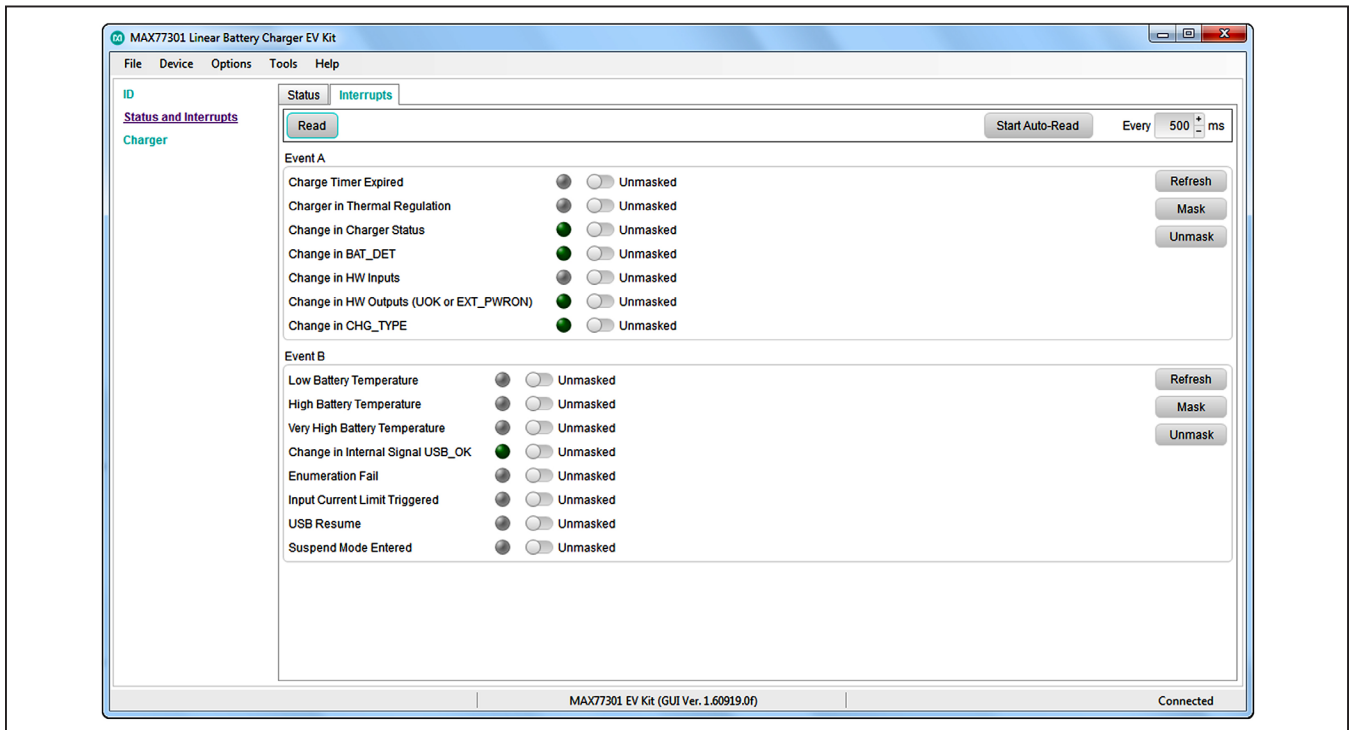

Figure 8. Interrupts Window

Component List

DESIGNATION	QTY	DESCRIPTION
C1, C3	2	10 μ F \pm 10%, 16V X5R ceramic capacitors (0805) TDK C2012X5R1C106KB Taiyo Yuden EMK212BJ106KG-T
C2, C4, C5, C6, C8	0	Not installed, capacitors
C7	1	22 μ F \pm 10%, 6.3V X5R ceramic capacitor (0805) TDK C2012X5R0J226K
C9	1	1 μ F \pm 10%, 6.3V X5R ceramic capacitor (0402) TDK C1005X5R0J105K
D1–D5	5	Red LEDs OSRAM LS L296-P2Q2-1-Z
D6	1	5.6V zener diode Micro Commercial Components MMXZ5232B-TP
J1	1	20-pin (2 x 10) right-angle receptacle Samtec SSW-110-02-S-D-RA
JU1, JU2, JU3, JU5	0	Not installed, 2-pin jumpers JU1, JU2, and JU5 are short (PCB trace); JU3 is open
JU4	1	4-pin header Digi-Key S1012E-36-ND
JU6–JU9	4	3-pin headers Digi-Key S1012E-36-ND

DESIGNATION	QTY	DESCRIPTION
JU10	1	2-pin header Digi-Key S1012E-36-ND
P1	1	Micro-B USB receptacle Hirose H11635CT-ND or ZX62-AB-5PA(11)
R1, R2	2	33.2 Ω \pm 1% resistors (0402)
R3, R4, R5, R11, R12	5	270 Ω \pm 5% resistors (0402)
R6, R7	0	Not installed, resistors
R8	1	100k Ω NTC thermistor (β = 4250) Murata NCP15WF104F03RC
R9, R10	2	2.21k Ω \pm 1% resistors (0402)
R13–R16, R19	5	10k Ω \pm 1% resistors (0402)
R17	1	47k Ω \pm 1% resistor (0402)
R18	1	1k Ω \pm 1% resistor (0402)
U1	1	Dual-path Li+ charger with USB enumeration (25 WLP) Maxim MAX77301EWA+T
Y1	1	12MHz \pm 2500ppm crystal Murata CSTCE12M0G15L
—	1	USB A-to-Micro-B cable, 3ft (1m) Hirose ZX64-B-5S-1000-STDA Digi-Key H11609-ND or WM17145-ND Molex 68784-0001
—	1	PCB: MAX77301EVKIT#

Component Suppliers

SUPPLIER	PHONE	WEB
Hirose Electric USA, Inc.	805-522-7958	www.hiroseusa.com
Micro Commercial Components Corp.	818-701-4933	www.mccsemi.com
Murata Electronics North America, Inc.	770-436-1300	www.murata-northamerica.com
OSRAM AG	978-777-1900	www.osram.com
Taiyo Yuden	800-348-2496	www.t-yuden.com
TDK Corp.	847-803-6100	www.component.tdk.com
Vishay	402-563-6866	www.vishay.com

Note: Indicate that you are using the MAX77301 when contacting these component suppliers.

Ordering Information

PART	TYPE
MAX77301EVKIT#	EV Kit

#Denotes RoHS compliant.

MAX77301 EV Kit PCB Layouts (continued)

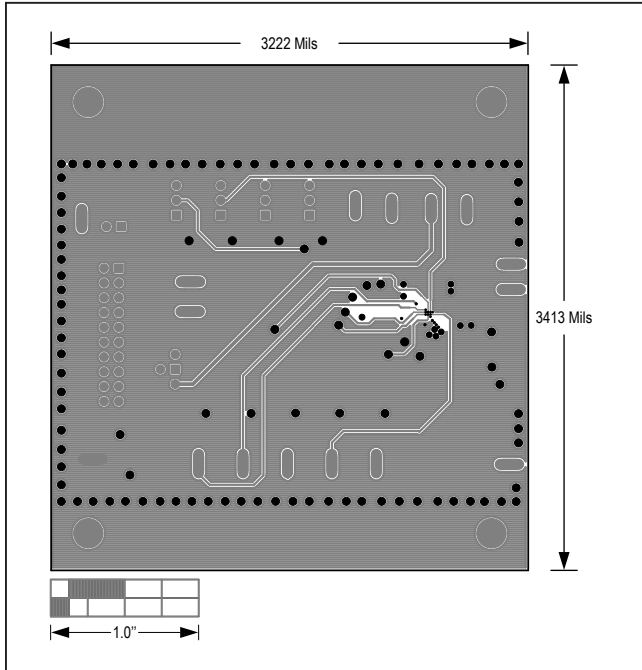

Figure 13. MAX77301 EV Kit PCB Layout—Inner Layer 3

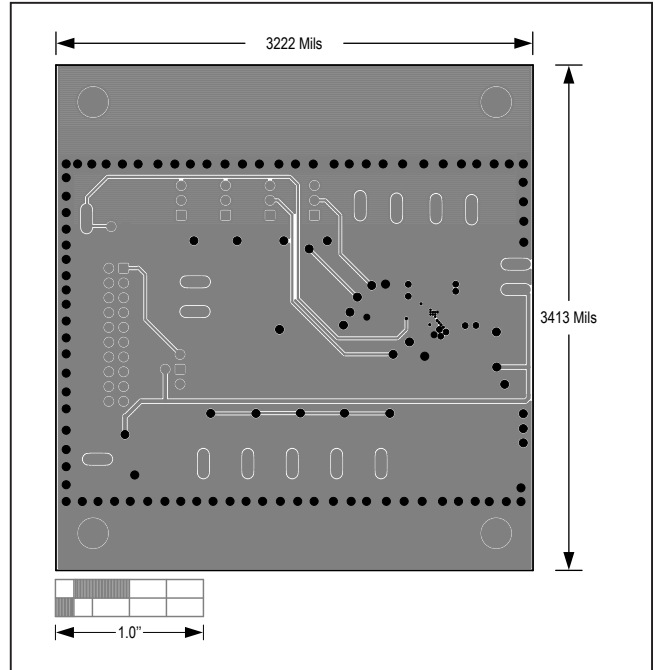

Figure 14. MAX77301 EV Kit PCB Layout—Solder Side

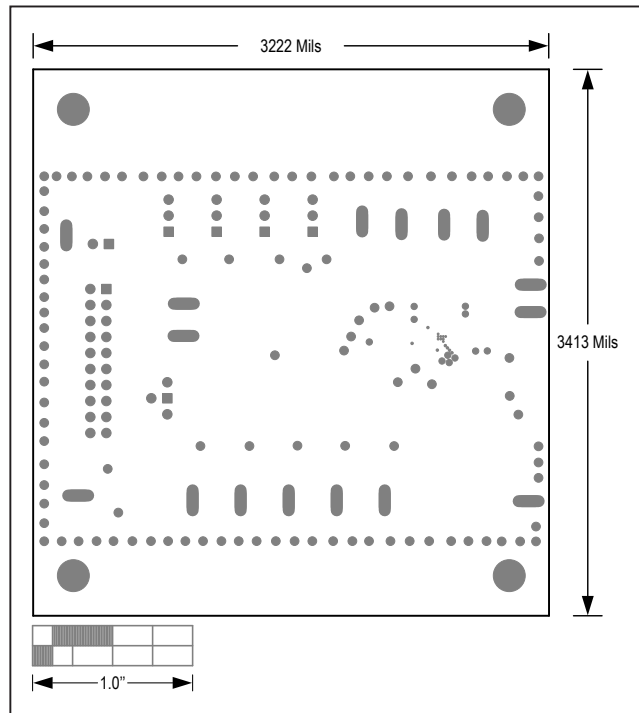

Figure 15. MAX77301 EV Kit Component Placement Guide—Solder Side

Revision History

REVISION NUMBER	REVISION DATE	DESCRIPTION	PAGES CHANGED
0	2/17	Initial release	—
1	4/21	Added MAX77301A to title	All

For pricing, delivery, and ordering information, please contact Maxim Direct at 1-888-629-4642, or visit Maxim Integrated's website at www.maximintegrated.com.

Maxim Integrated cannot assume responsibility for use of any circuitry other than circuitry entirely embodied in a Maxim Integrated product. No circuit patent licenses are implied. Maxim Integrated reserves the right to change the circuitry and specifications without notice at any time.