

## Specification

- Part No. : **GW.05.0E23**
- Product Name : Dual-Band WiFi 2.4/5.8GHz Fakra Code I Mount  
Hinged Monopole Antenna
- Features : High Efficiency – With and Without Ground Plane  
Wi-Fi / Bluetooth / Zigbee  
Extremely Compact – 69.6mm height, Ø 5mm  
Aesthetic Look and Feel  
Fits in places other antennas can't  
Peak Gain Compliant with Most WiFi Modules  
Connector: Fakra Code I Beige SMB(F)  
**ROHS Compliant**



## 1. Introduction

The GW.05.0E23 dual band WiFi Hinged Rotatable Fakra Mount Antenna is a high efficiency monopole antenna for Wi-Fi, WLAN, Zigbee, Bluetooth, and 802.11a/b/g/n/ac applications. The direct mount Fakra connector enables a more robust mating to the device compared to a SMA, the locking feature prevents the antenna coming loose due to vibration or shock.

This small antenna fits in places other antennas cannot since the radiating element can be moved and rotated in one hemisphere. For optimized efficiency, keep the element as far away from metal as possible.

Like all monopole antennas, the GW.05 works best when connected directly to the ground-plane of the device main PCB or to the outside of a metal housing. However, it maintains excellent performance even without a ground plane (>50%), making it the best all-around small WiFi terminal antenna on the market. Even compared with other much larger antennas, the GW.05 offers superior high-efficiency wide-band characteristics.

GW.05 is also available as a standard SMA(M) version.

Contact your regional Taoglas facility for support on testing and integration.

## 2. Specification

Parameter		Wireless Bands	
Straight Position			
Frequency (MHz)		2400~2500	5150~5850
Average Gain (dBi)	In Free Space	-4.63	-2.60
Efficiency (%)		34.49	55.03
Peak Gain (dBi)		3.73	0.64
Average Gain (dBi)	With 15x9cm Ground Plane	-5.27	-4.63
Efficiency (%)		29.74	34.65
Peak Gain (dBi)		0.64	0.34
Average Gain (dBi)	On 30x30cm Metal Plane Edge	-5.53	-4.17
Efficiency (%)		28.23	38.71
Peak Gain (dBi)		2.18	0.19
Average Gain (dBi)	On 30x30cm Metal Plane Center	-4.63	-4.72
Efficiency (%)		34.48	33.78
Peak Gain (dBi)		1.94	1.45
Return Loss (dB)		<-3	<-5

Bent Position 90°			
Average Gain (dBi)	In Free Space	-4.74	-2.12
Efficiency (%)		33.60	61.77
Peak Gain (dBi)		4.09	2.46
Average Gain (dBi)	With 15x9cm Ground Plane	-5.32	-4.43
Efficiency (%)		29.45	36.29
Peak Gain (dBi)		0.38	1.27
Average Gain (dBi)	On 30x30cm Metal Plane Edge	-5.57	-3.50
Efficiency (%)		27.93	44.97
Peak Gain (dBi)		1.42	1.64
Average Gain (dBi)	On 30x30cm Metal Plane Center	-4.72	-3.99
Efficiency (%)		33.81	40.43
Peak Gain (dBi)		1.99	2.37
Return Loss (dB)		<-3	<-5
Radiation		Omni-directional	
Polarization		Linear	
Impedance		50 Ω	
Input Power		10W	
MECHANICAL			
Antenna length		69.6mm	
Antenna Diameter		5mm	
Casing		POM	
Connector		Fakra Code I Beige SMB(F)	
Weight		6g	
ENVIRONMENTAL			
Operation Temperature		-40°C ~ + 85°C	
Storage Temperature		-40°C ~ + 85°C	
Humidity		Non-condensing 65°C 95% RH	

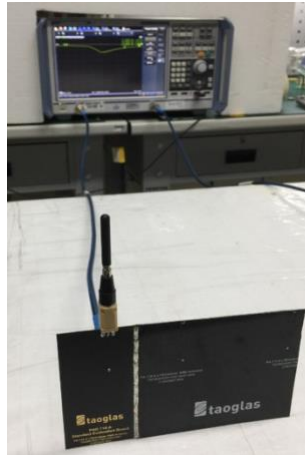
### 3. Antenna Characteristics

#### 3.1 Testing Setup

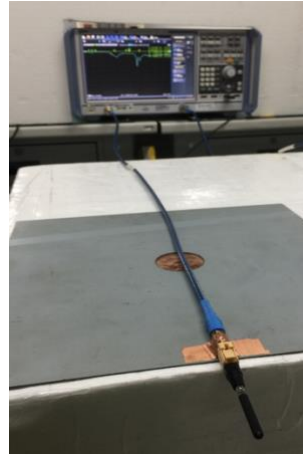
##### Antenna Straight Position



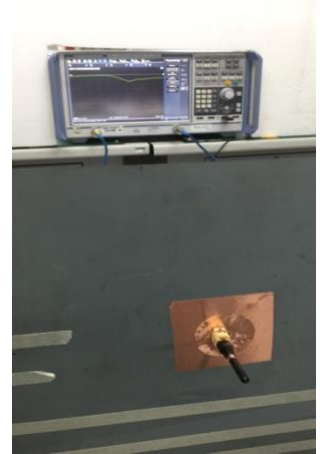
a) In free space



b) with 15\*9cm  
Ground Plane

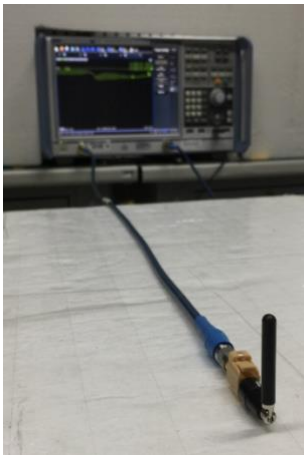


c) with 30\*30cm  
Ground Plane Edge



d) with 30\*30cm  
Ground Plane Center

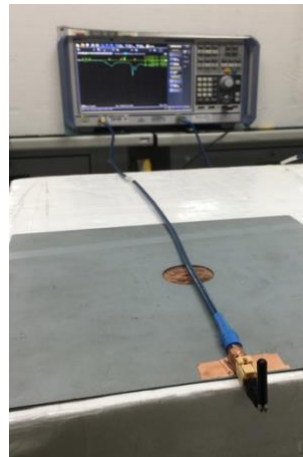
##### Antenna Bent 90° Position



a) In free space



b) with 15\*9cm  
Ground Plane



c) with 30\*30cm  
Ground Plane Edge

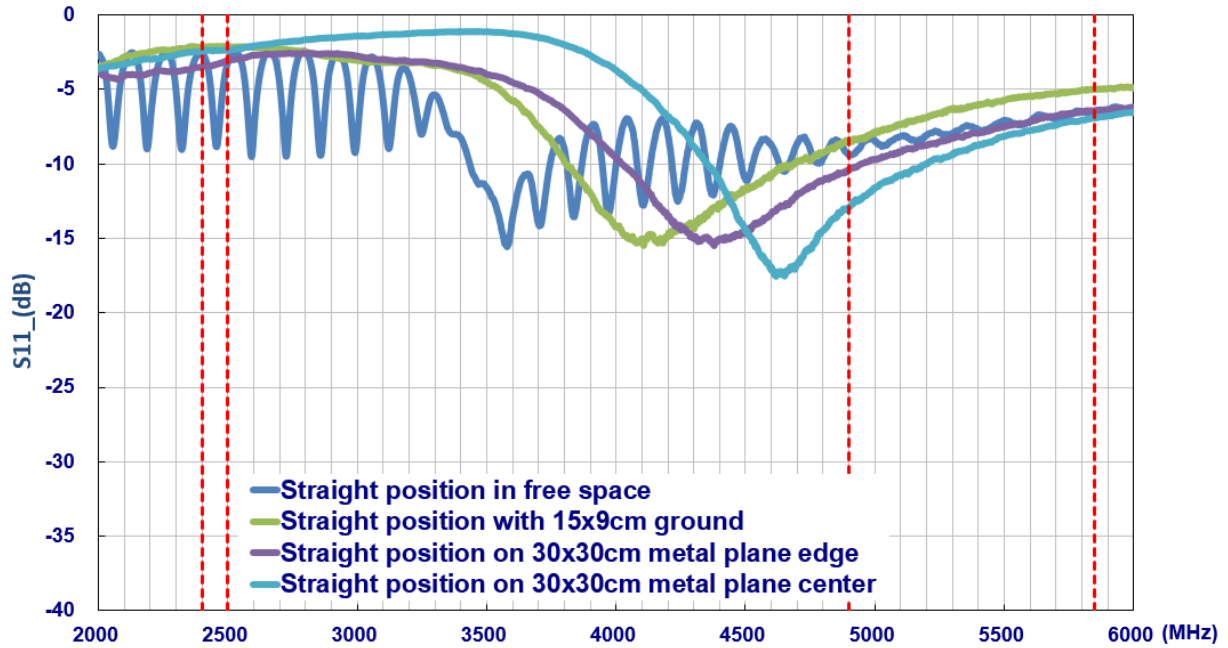


d) with 30\*30cm  
Ground Plane Center

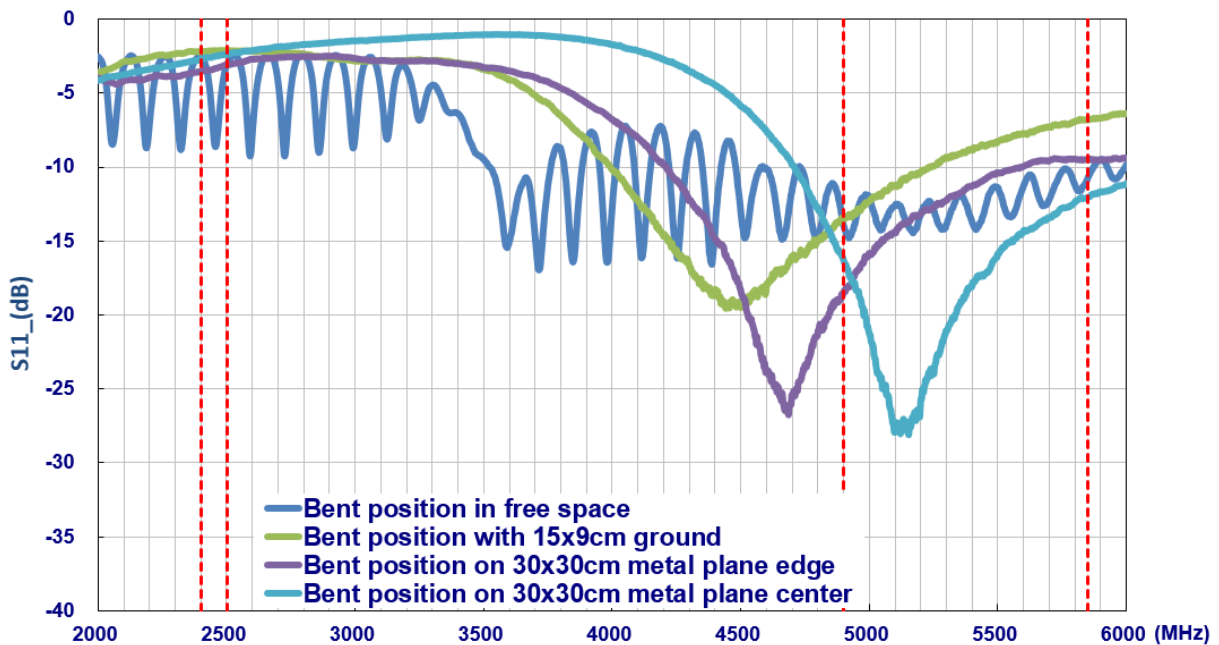
Center

**Figure.1** Measurement environments

### 3.2 Return Loss

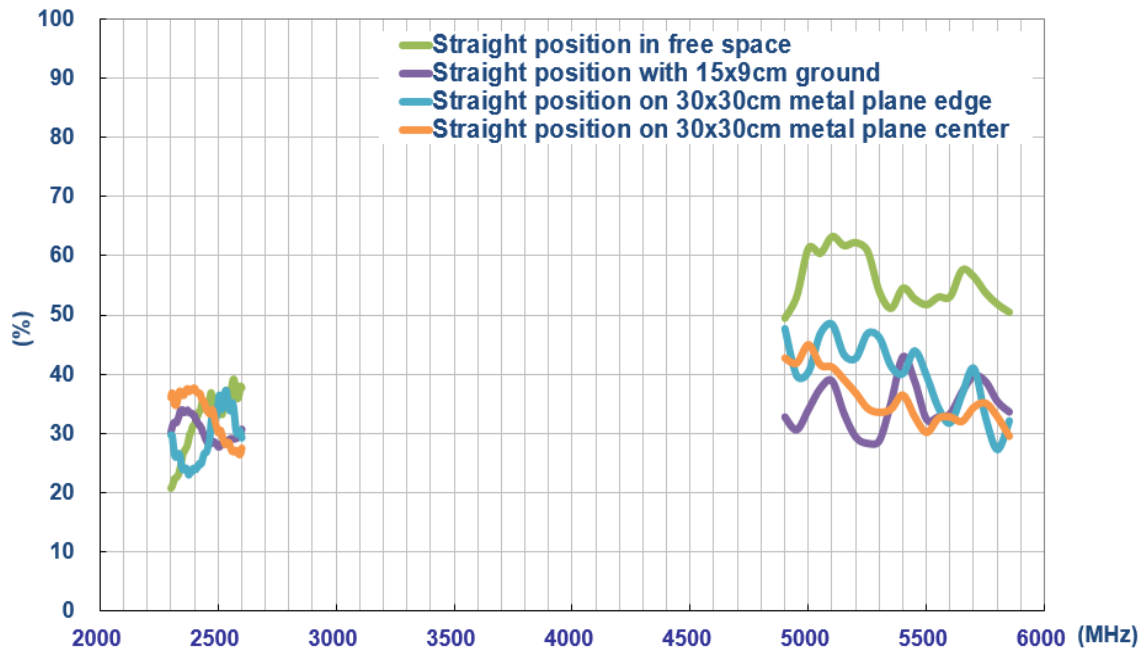


**Figure2.** Return loss of GW.05 antenna with straight position

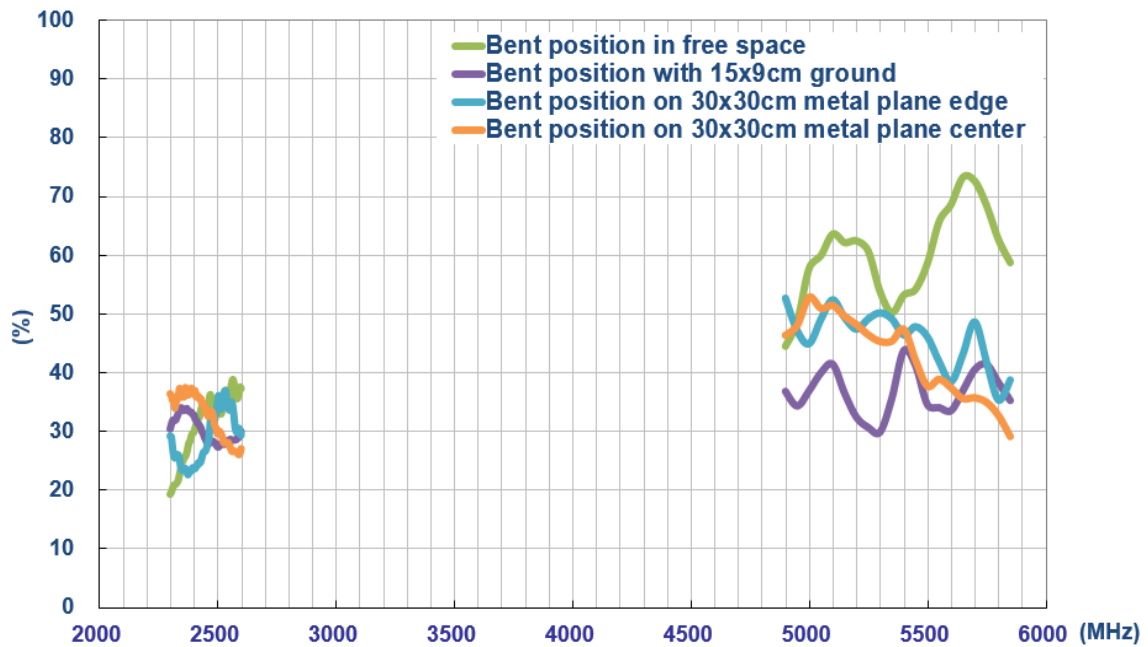


**Figure3.** Return loss of GW.05 antenna with bent position

### 3.3 Efficiency

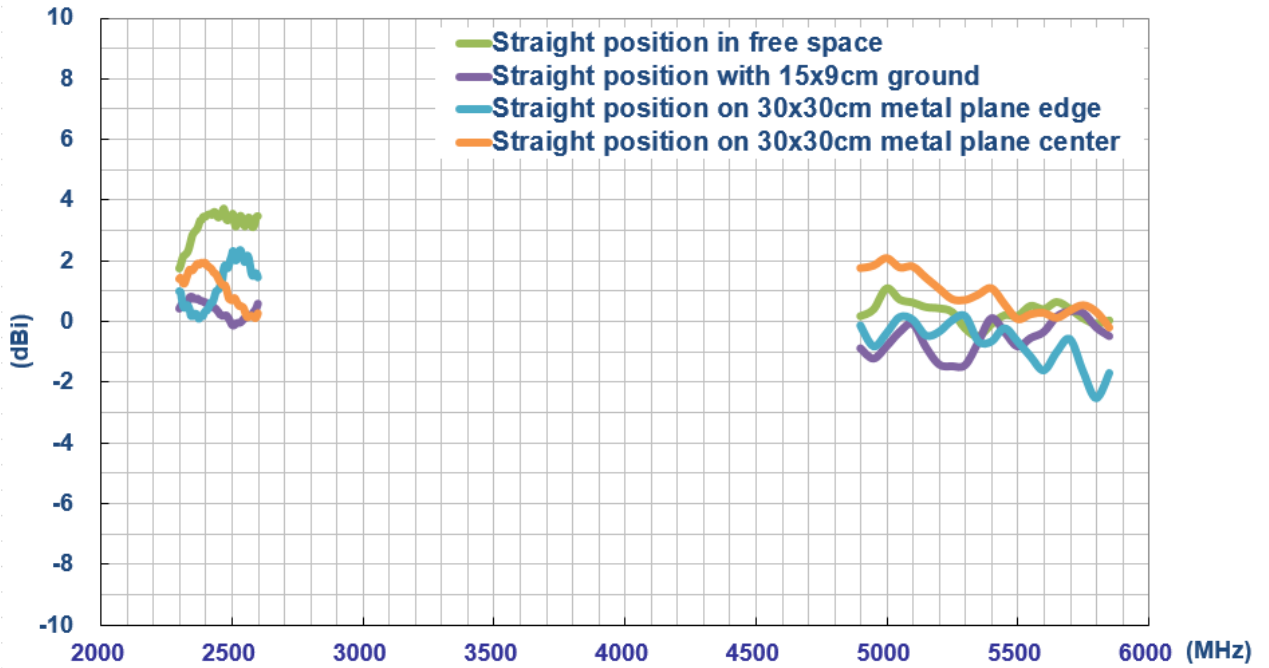


**Figure4.** Efficiency of GW.05 antenna with straight position

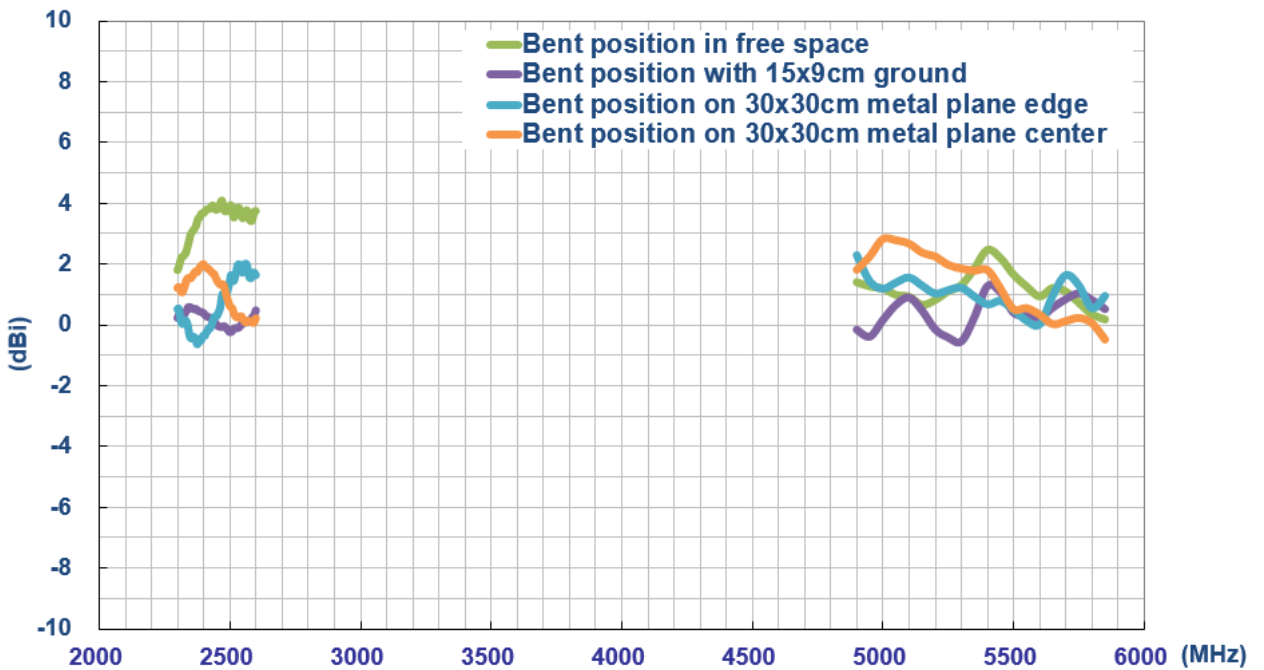


**Figure5.** Efficiency of GW.05 antenna with bent position

### 3.4 Peak Gain



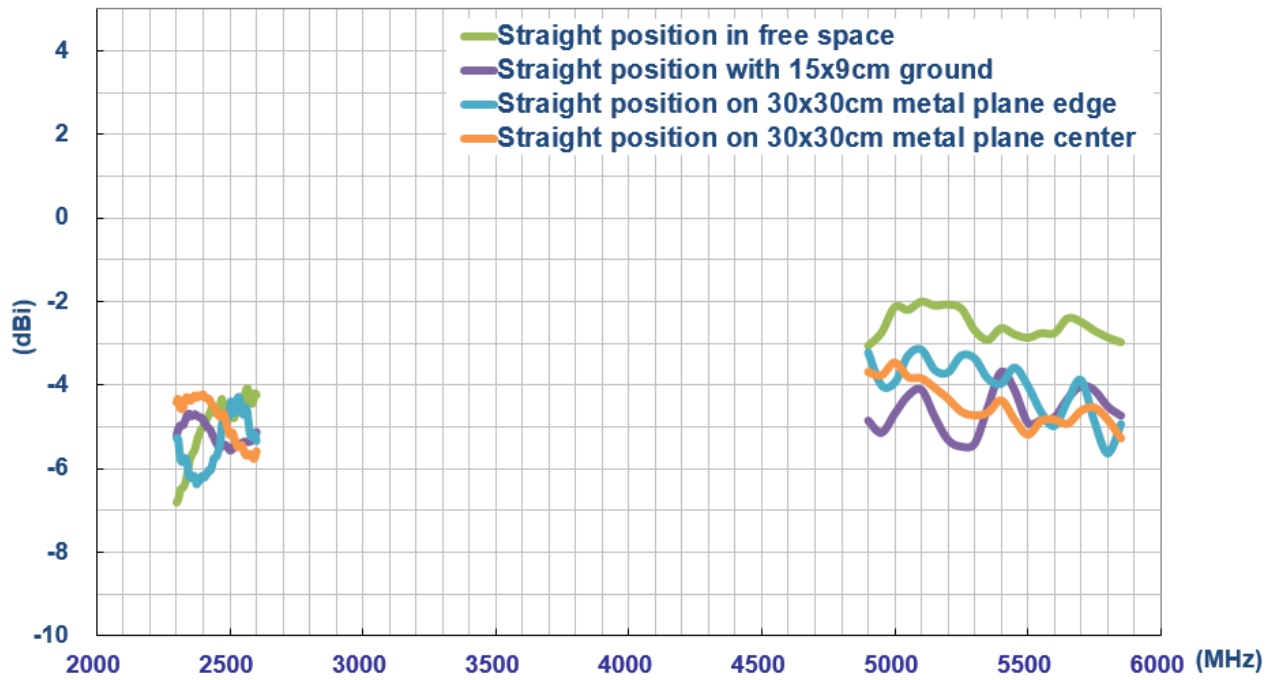
**Figure6.** Peak gain of GW.05 antenna with straight position



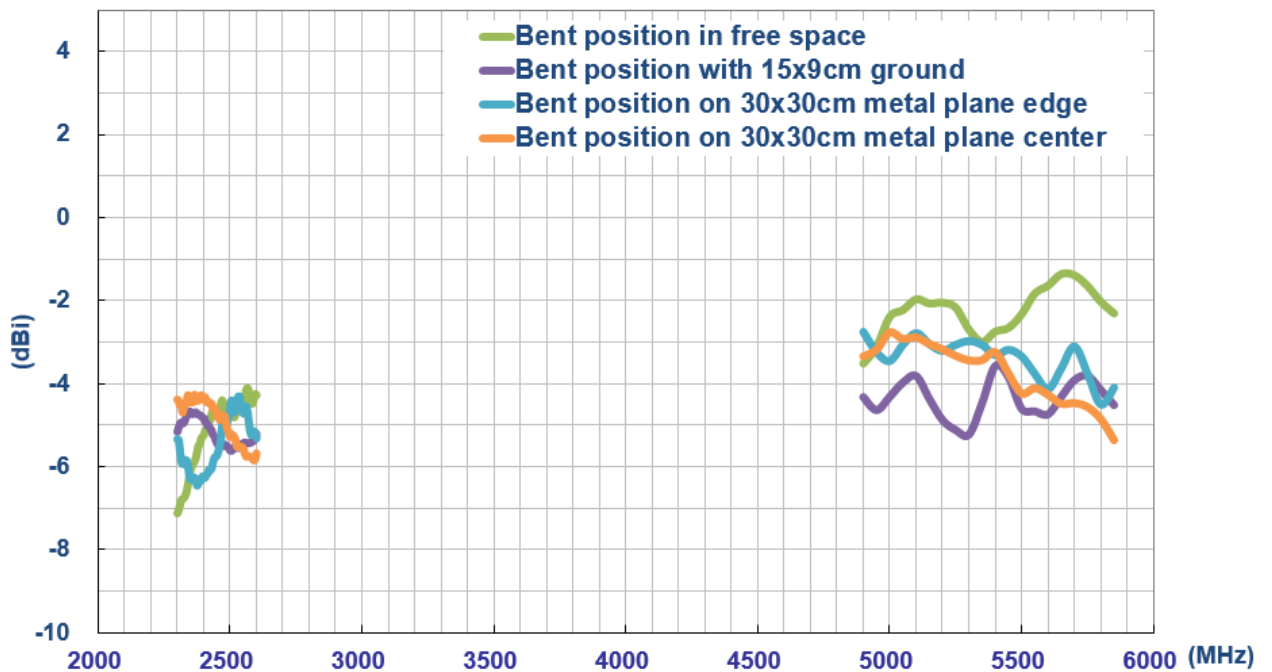
**Figure7.** Peak gain of GW.05 antenna with bent position



### 3.5 Average Gain



**Figure8.** Average gain of GW.05 with antenna straight position

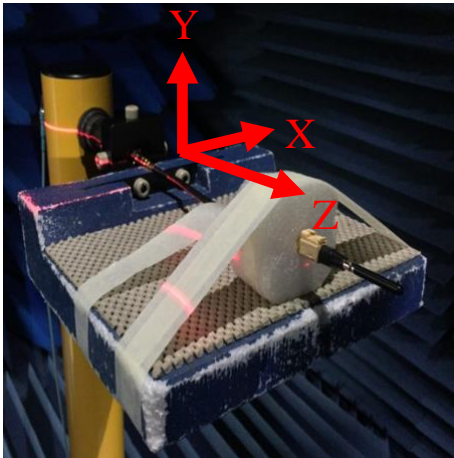


**Figure9.** Average gain of GW.05 antenna with bent position

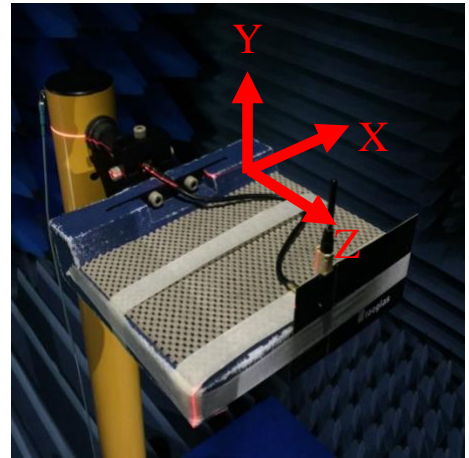
## 4. Antenna Radiation Patterns

The antenna radiation patterns were measured in a CTIA certified ETS Anechoic Chamber. The measurement setup is shown below.

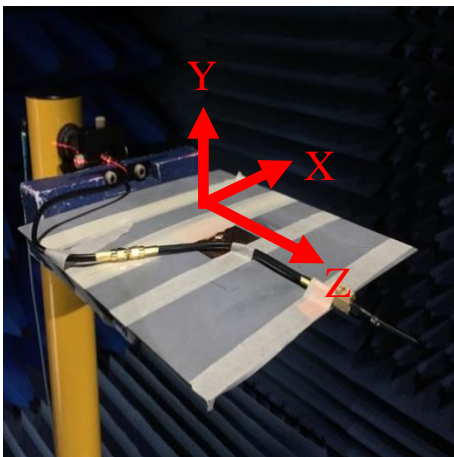
### Antenna with Straight Position



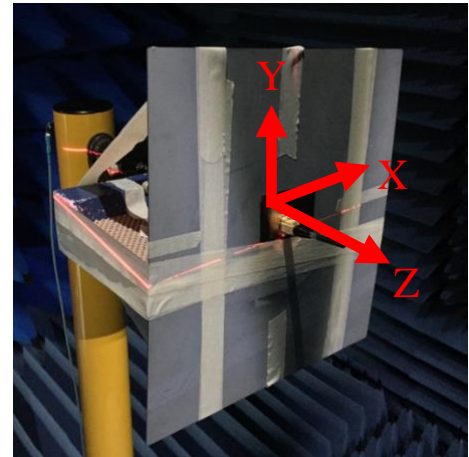
In free space



15x9cm ground plane

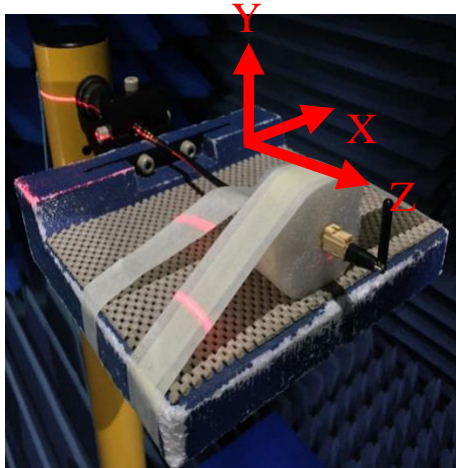


30x30cm metal ground center  
edge

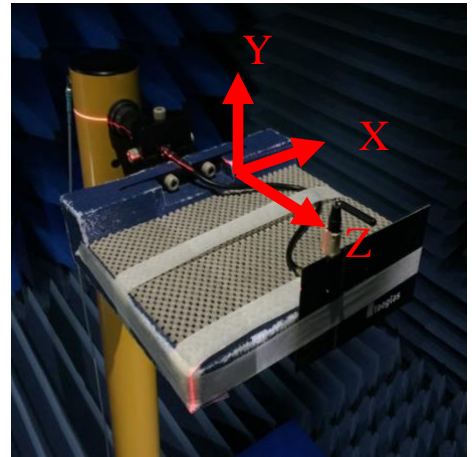


30x30cm metal ground

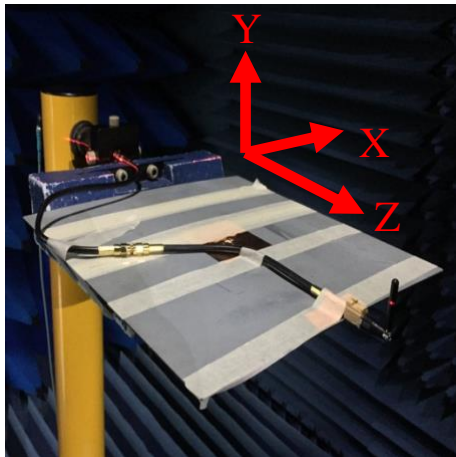
**Antenna Bent Position**



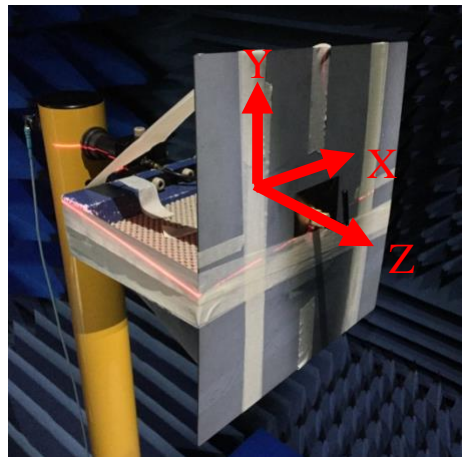
In free space



15x9cm ground plane



30x30cm metal ground center

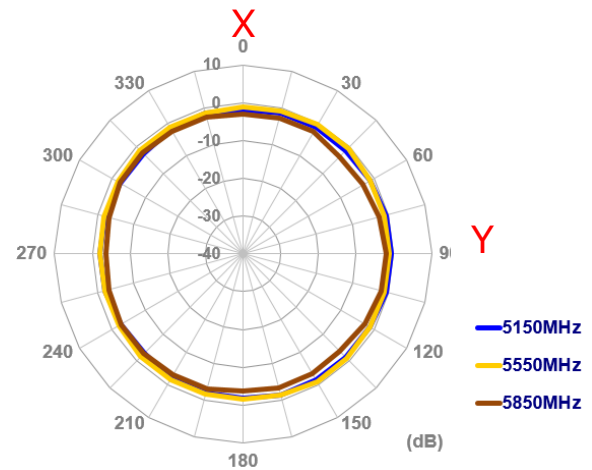
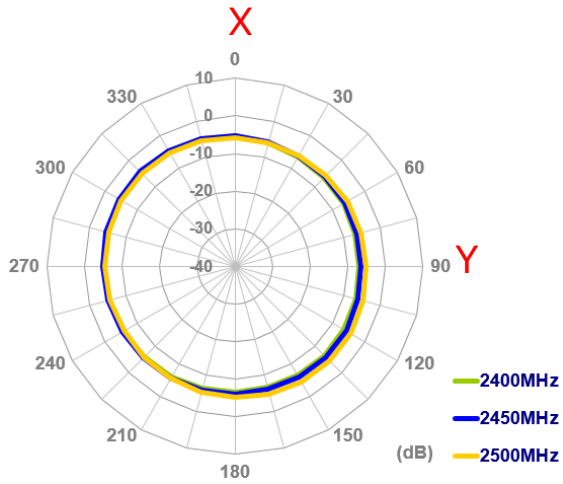


30x30cm metal ground edge

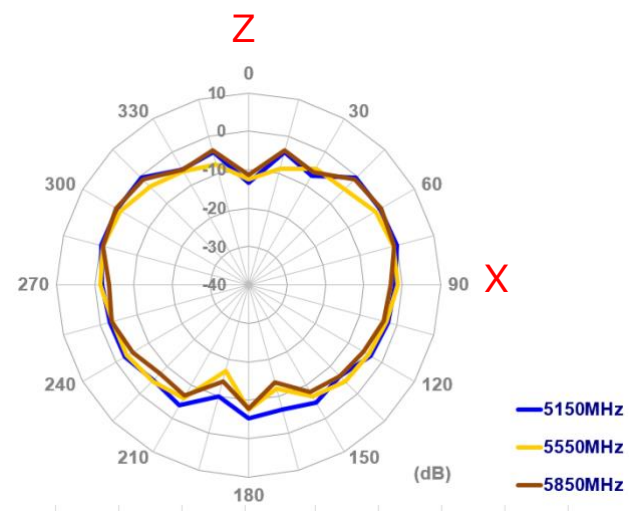
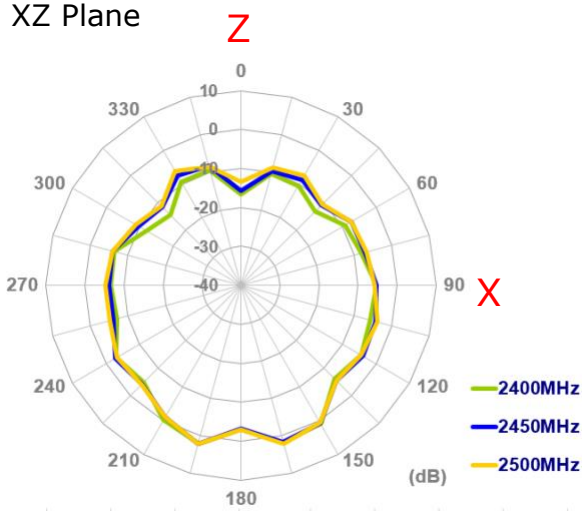
**Figure.10.** Testing Setup in ETS Anechoic Chamber

## 4.1 2D Radiation Pattern (Straight position in free space)

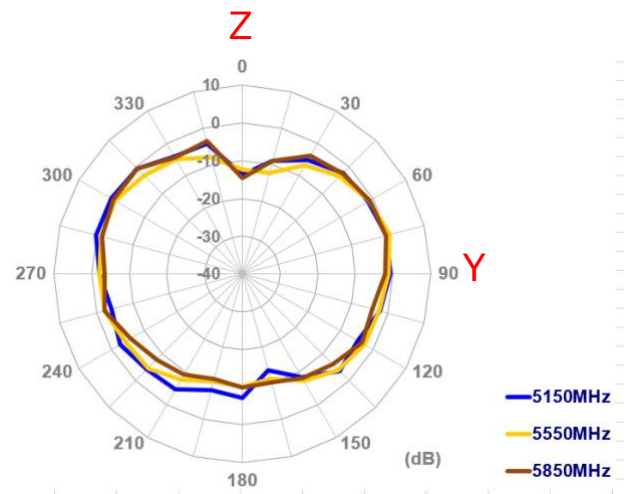
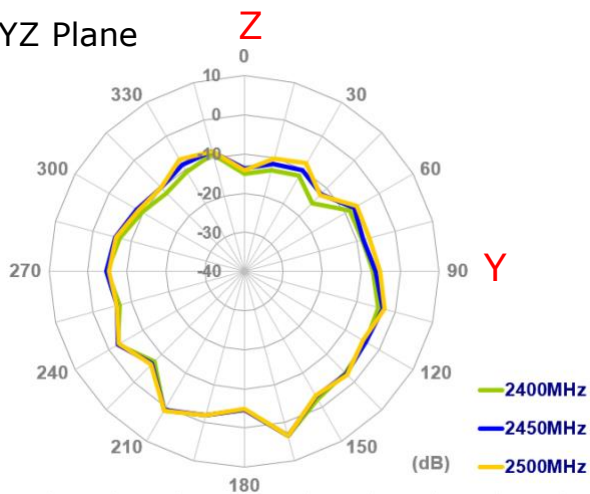
XY Plane



XZ Plane



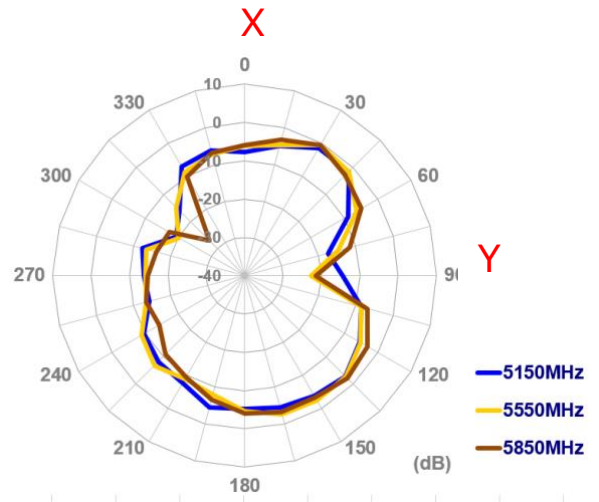
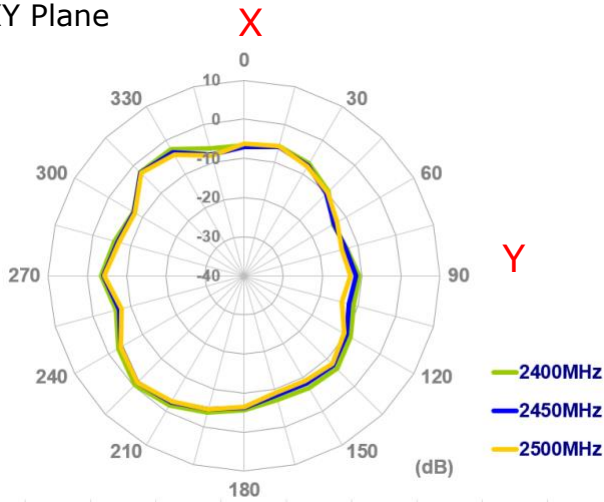
YZ Plane



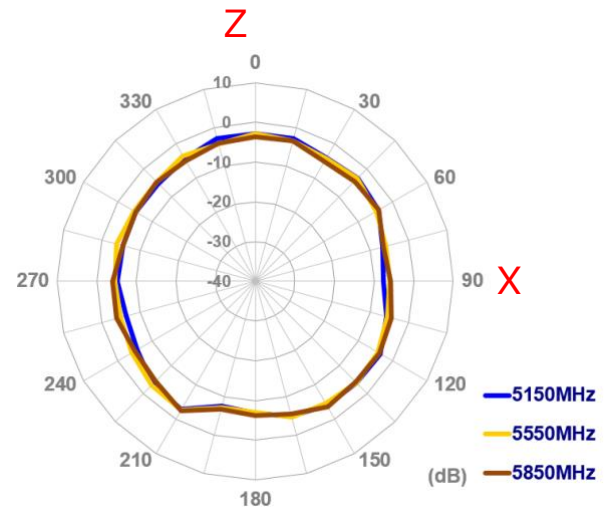
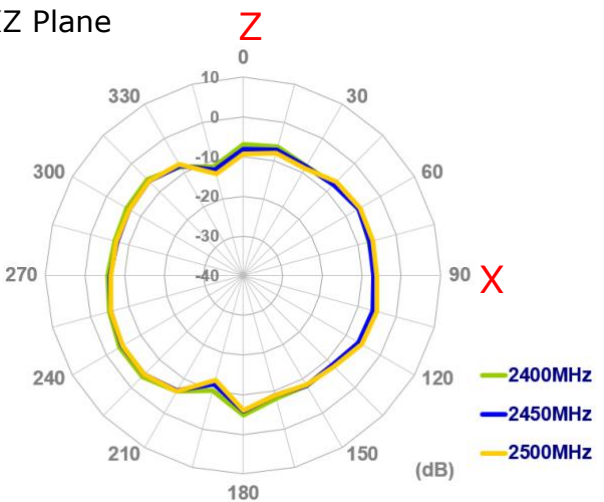


## 4.2 2D Radiation Pattern (Straight position with 15x9cm ground plane)

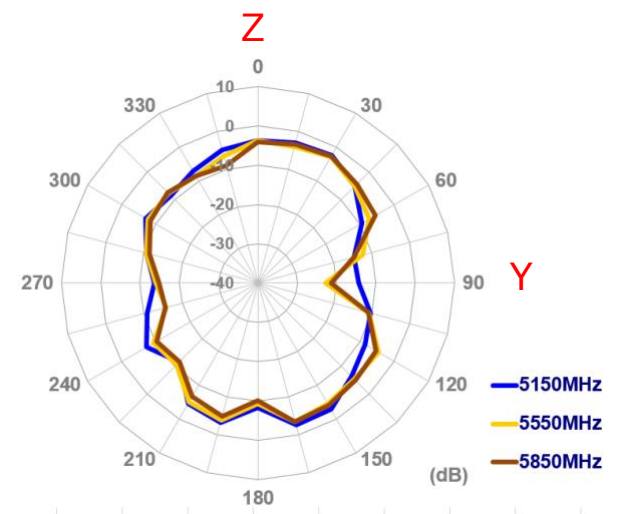
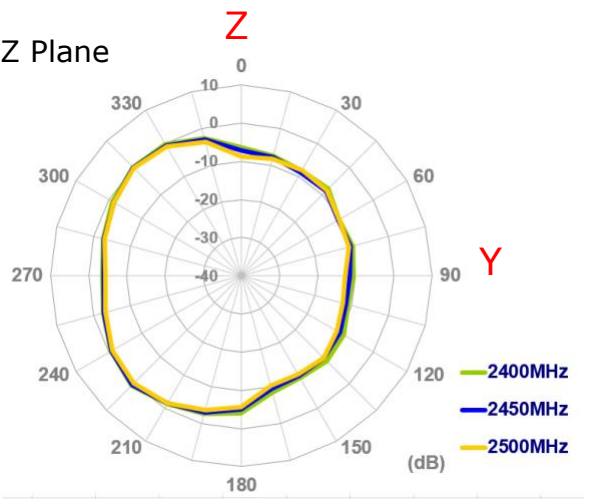
XY Plane



XZ Plane

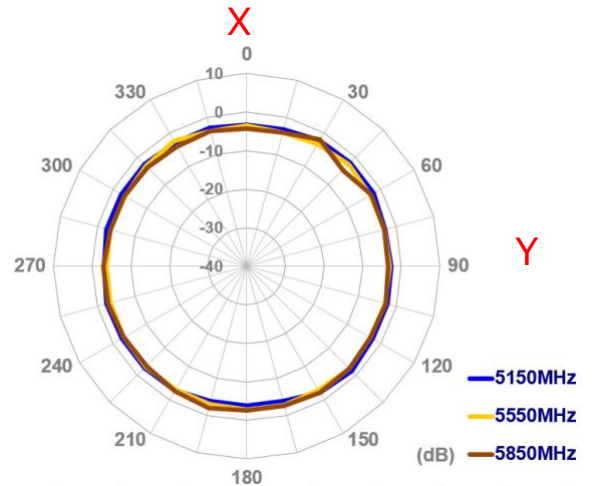
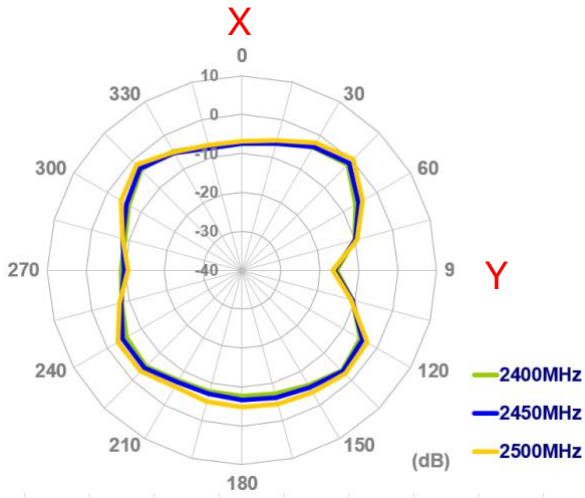


YZ Plane

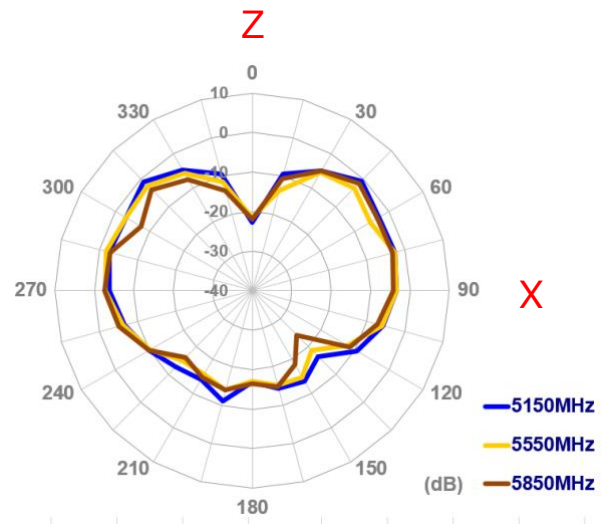
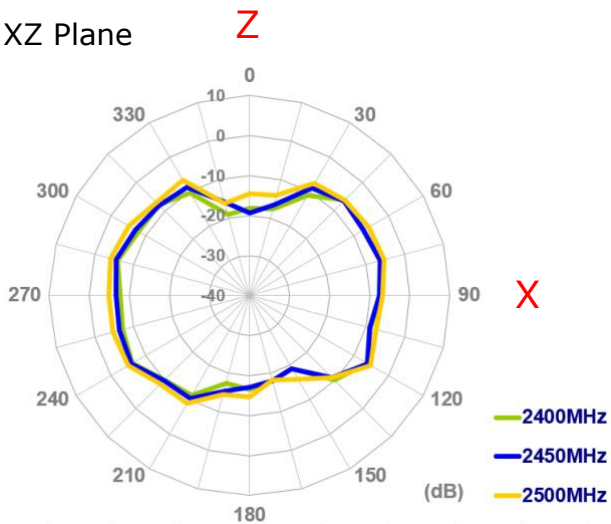


### 4.3 2D Radiation Pattern (Straight position with 30x30cm ground plane edge)

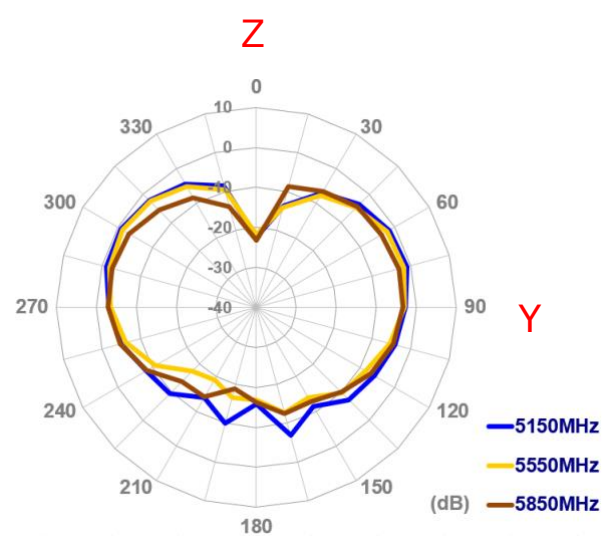
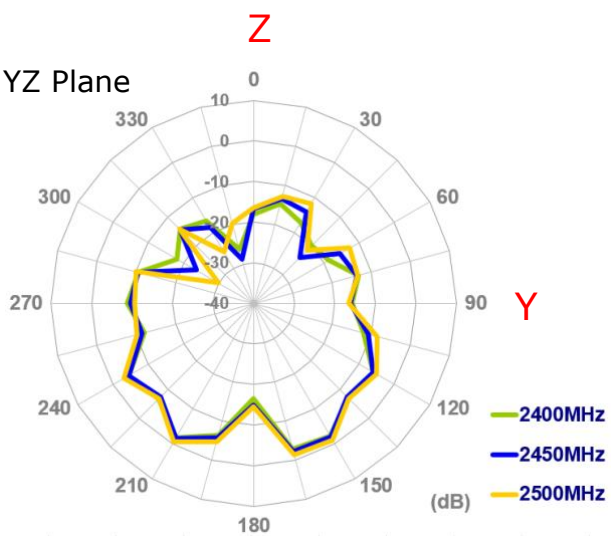
XY Plane



XZ Plane

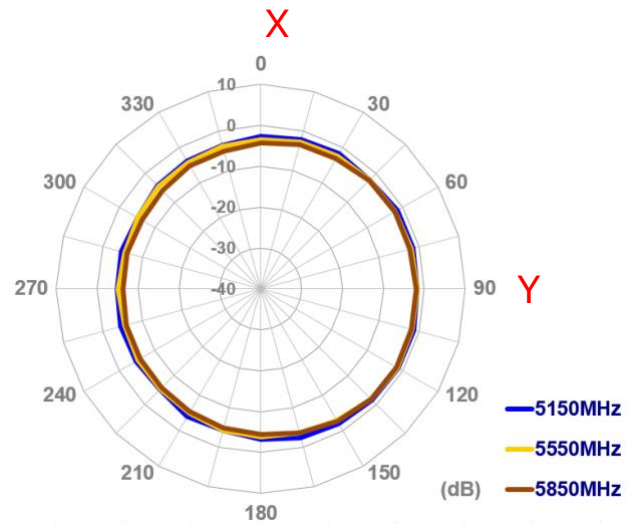
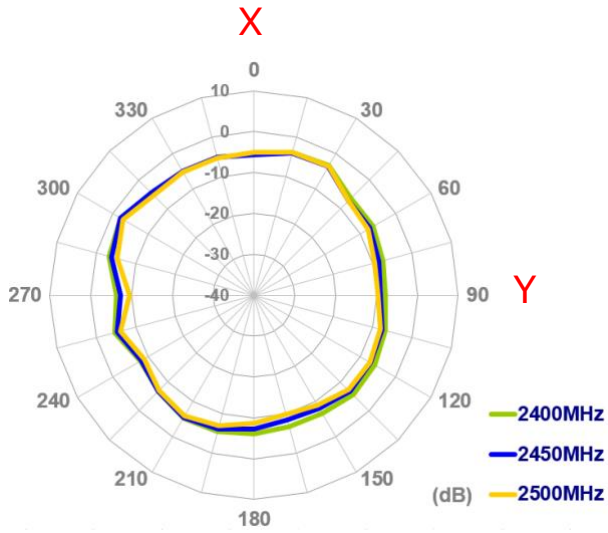


YZ Plane

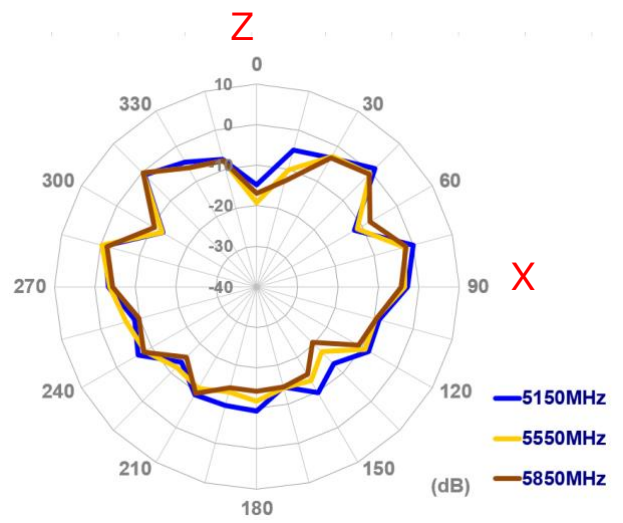
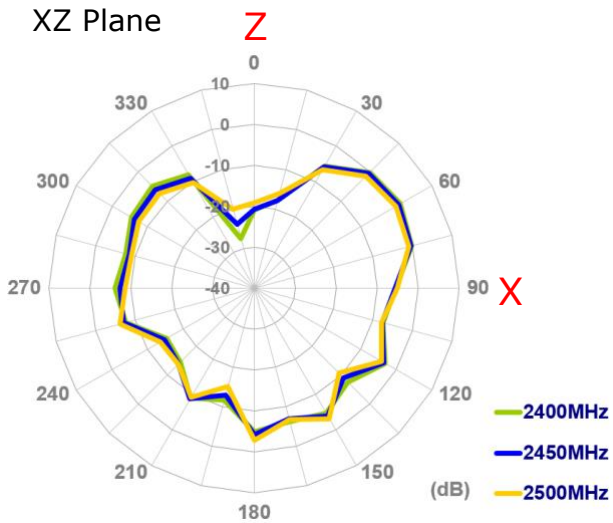


### 4.3 2D Radiation Pattern (Straight position with 30x30cm ground plane center)

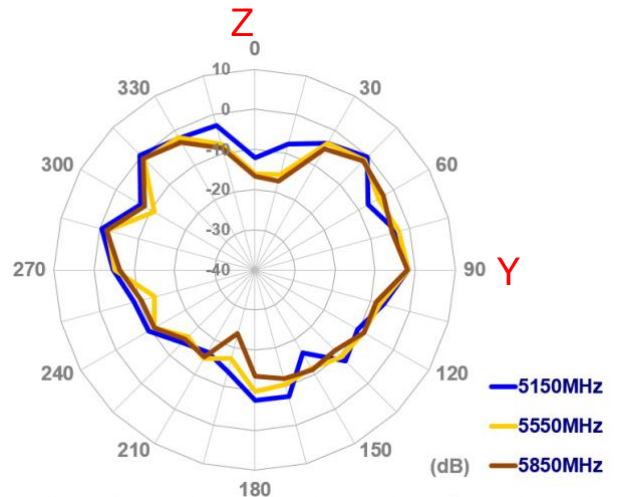
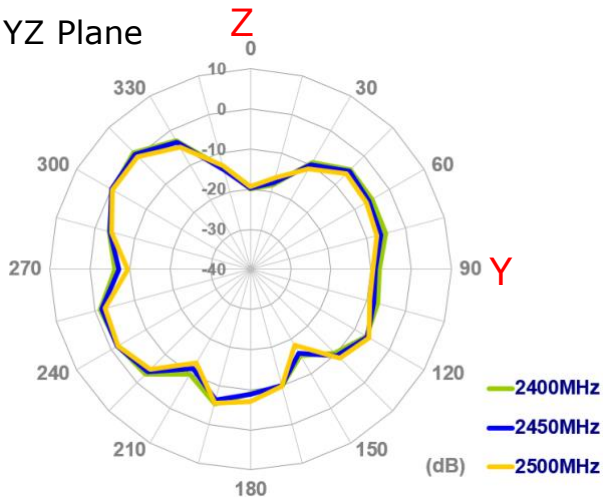
XY Plane



XZ Plane



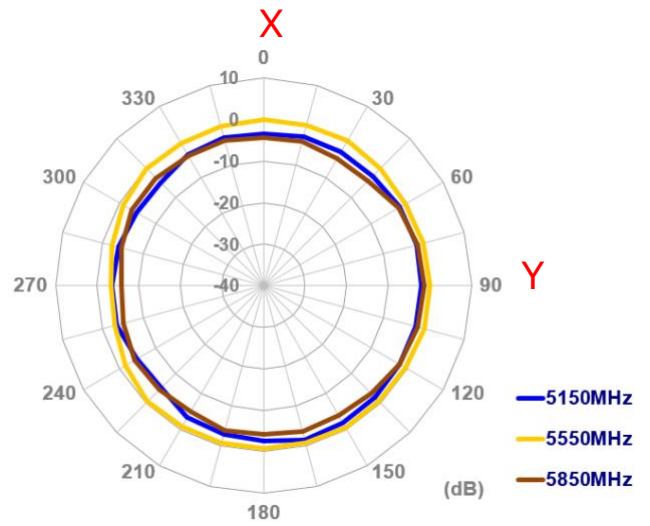
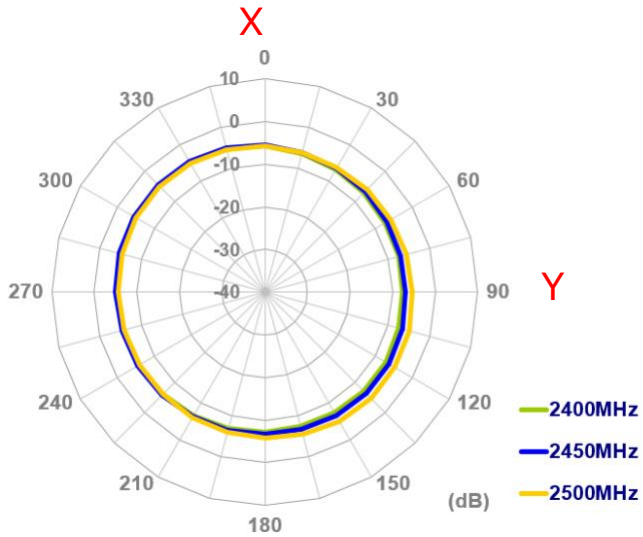
YZ Plane



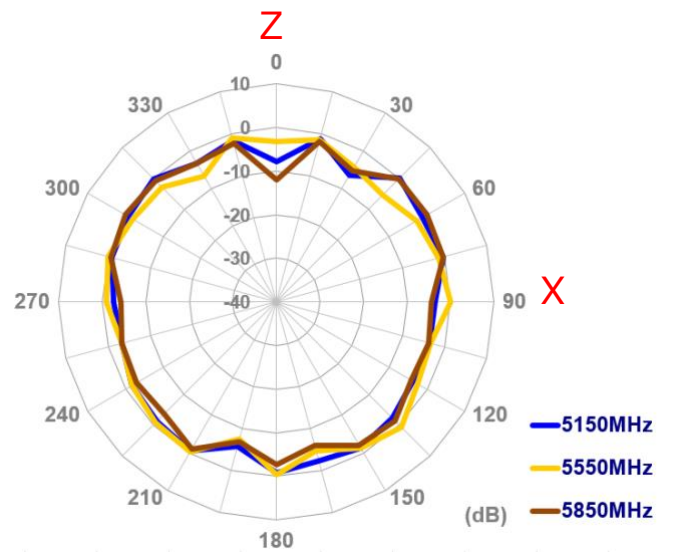
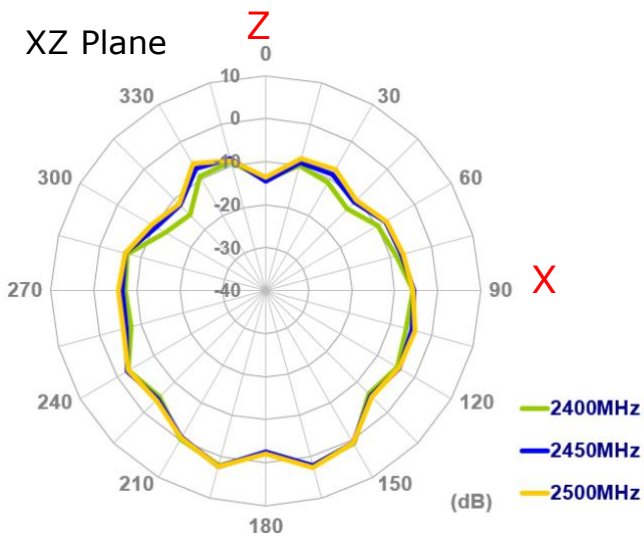


## 4.4 2D Radiation Pattern (Bent position in free space)

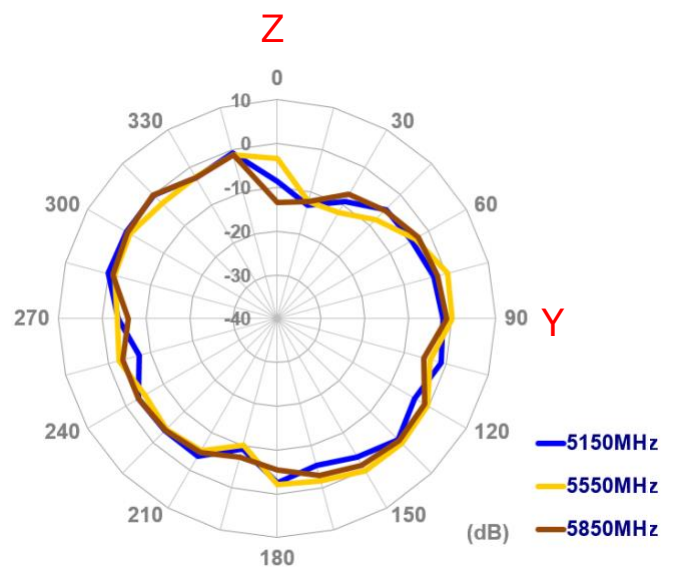
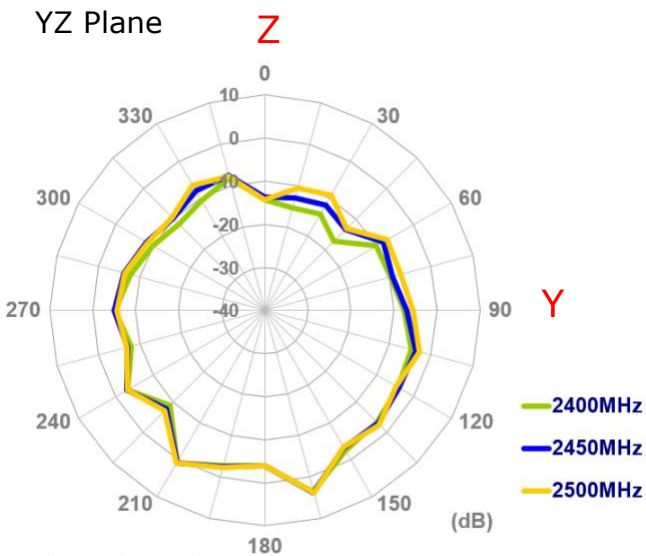
XY Plane



XZ Plane



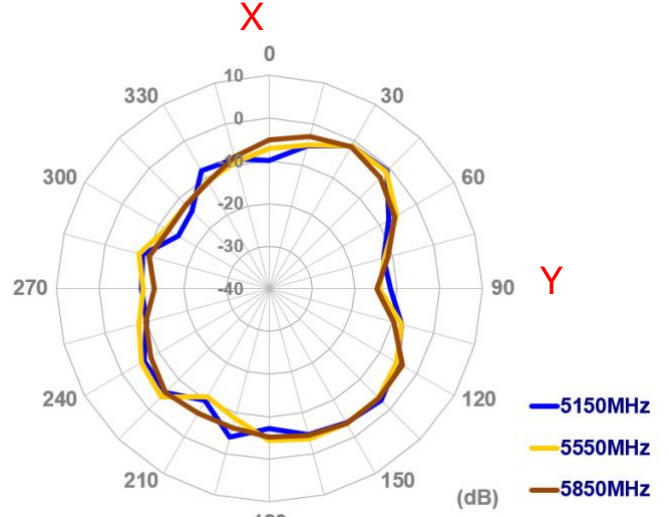
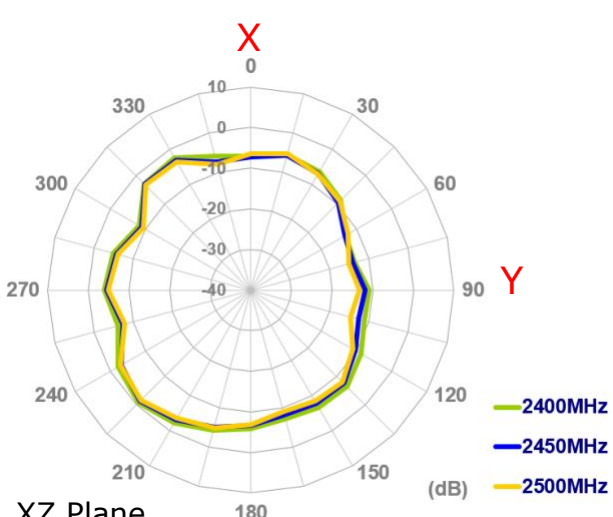
YZ Plane



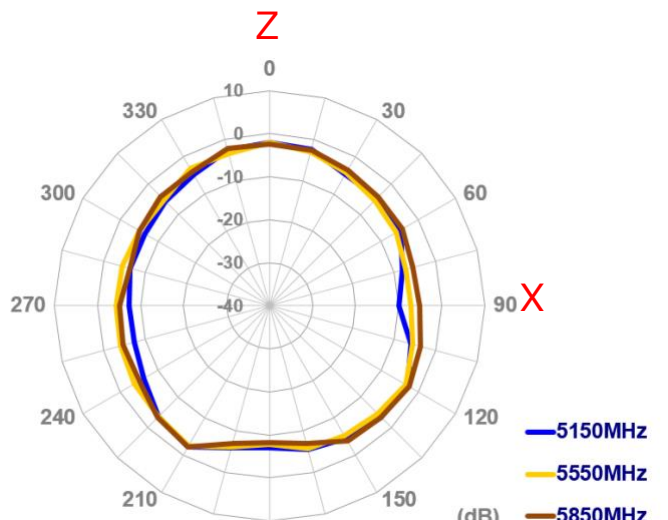
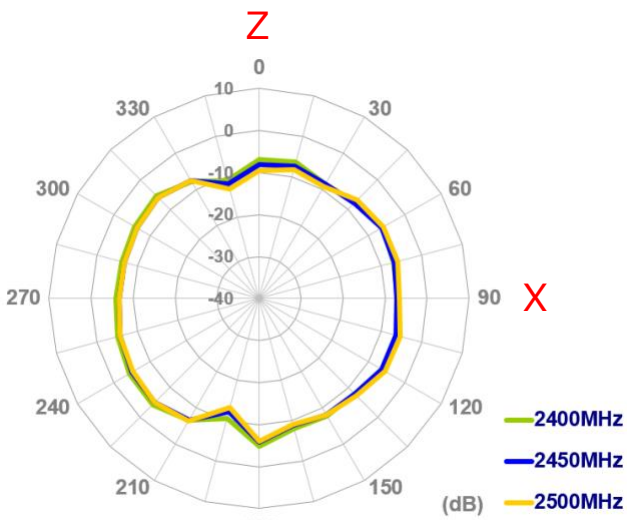


## 4.5 2D Radiation Pattern (Bent position with 15x9cm ground plane)

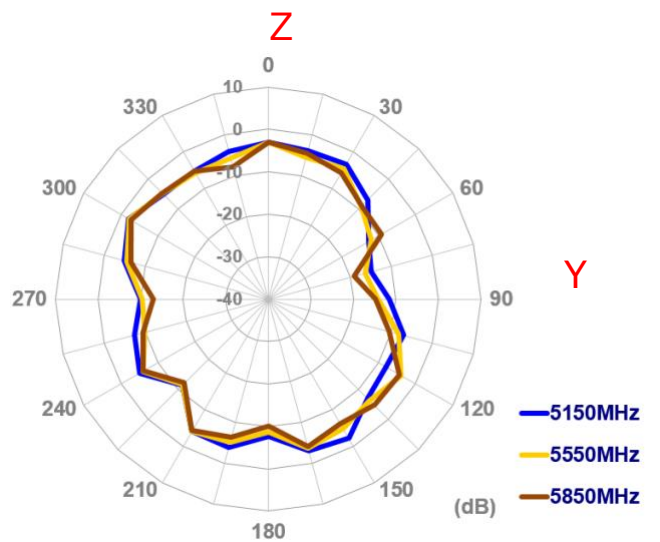
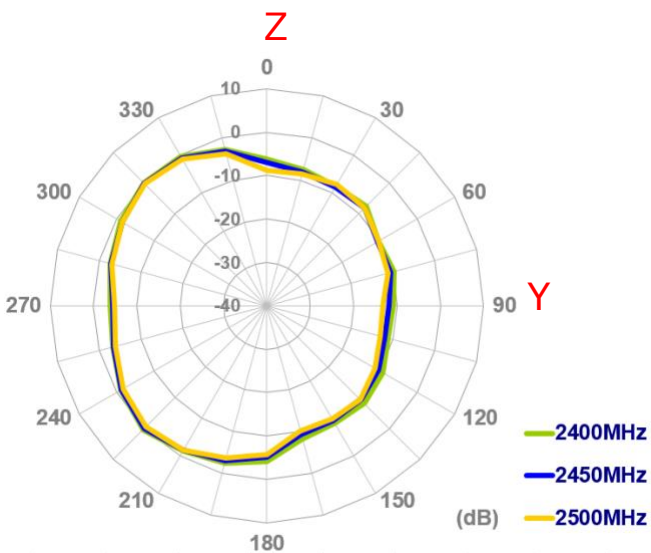
XY Plane



XZ Plane

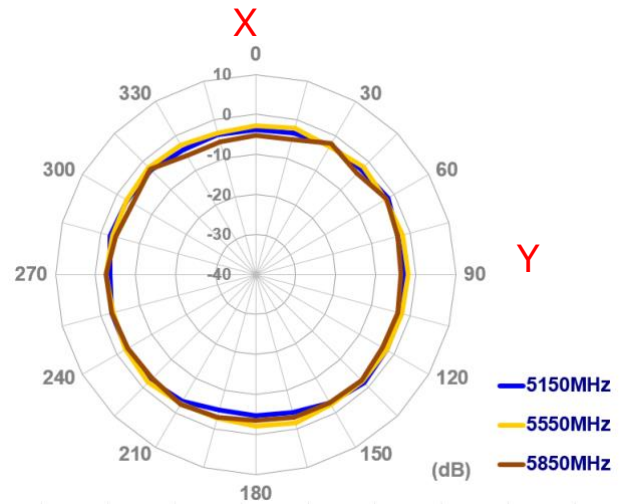
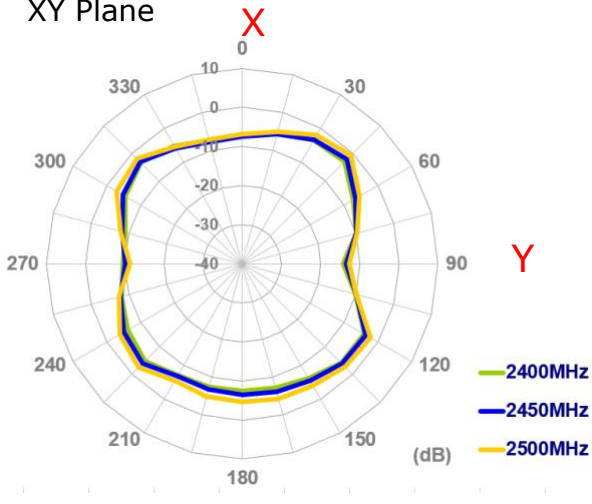


YZ Plane

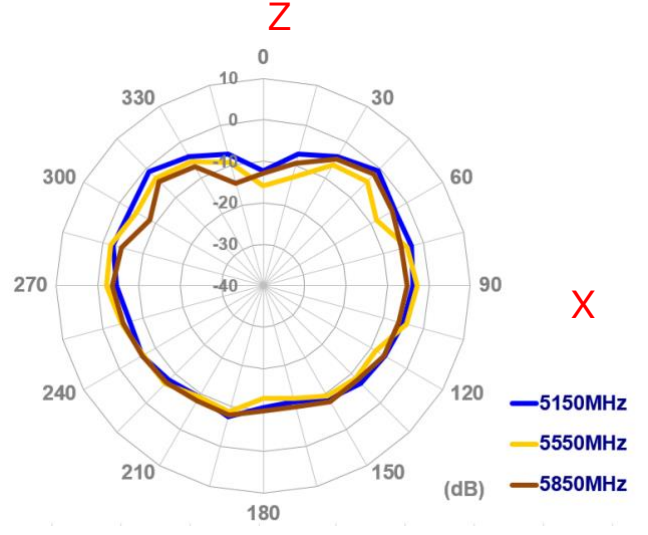
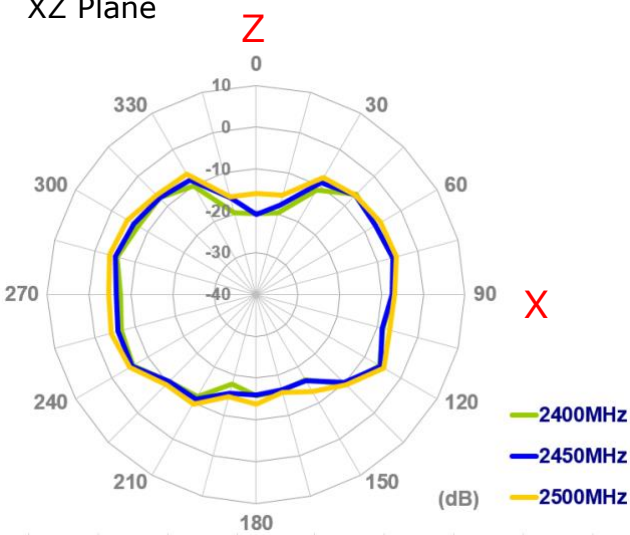


### 4.7 2D Radiation Pattern (Bent position with 30x30cm ground plane edge)

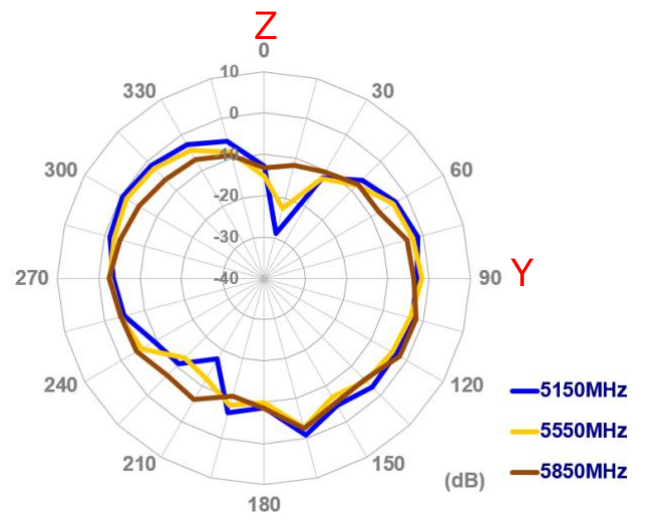
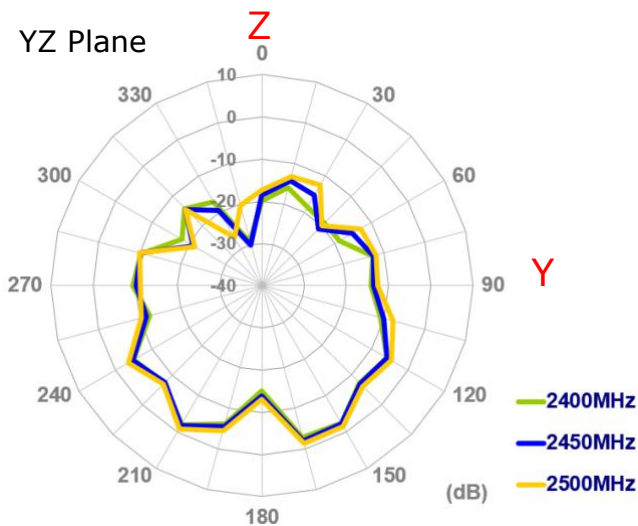
XY Plane



XZ Plane

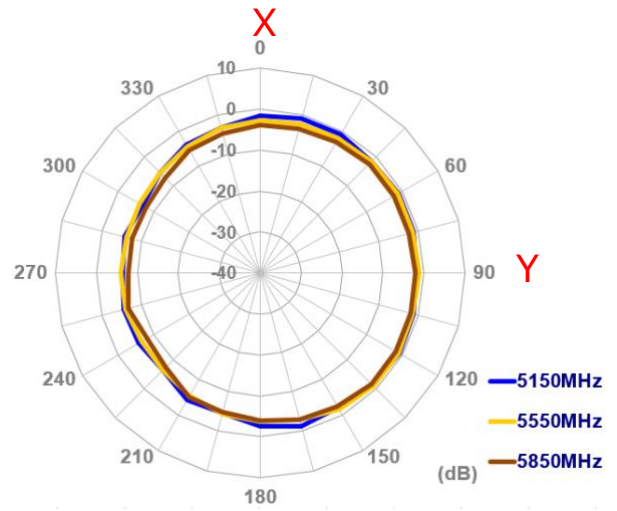
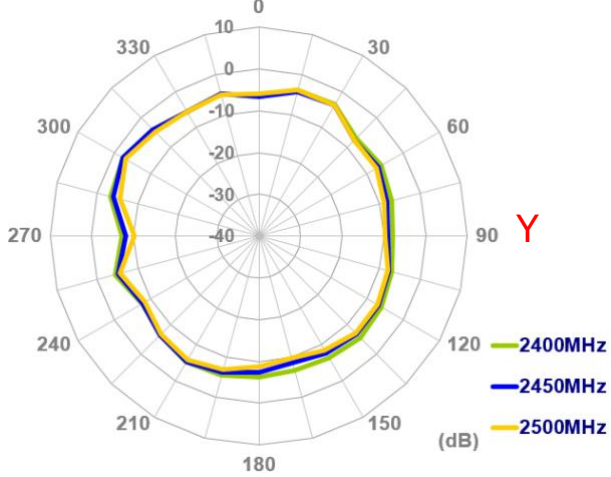


YZ Plane

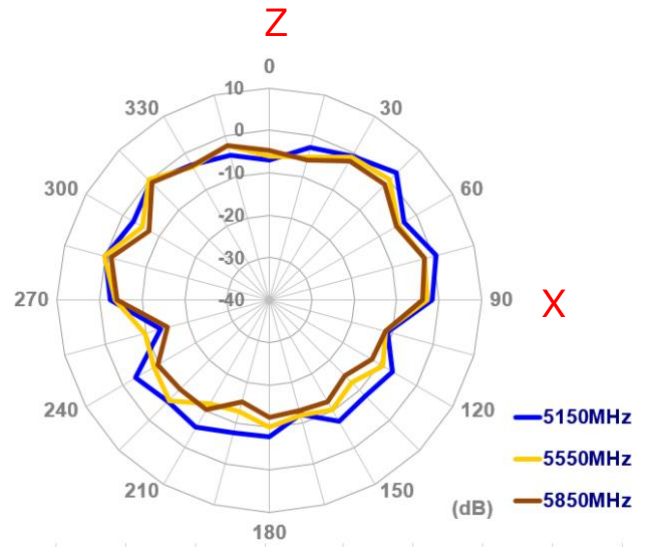
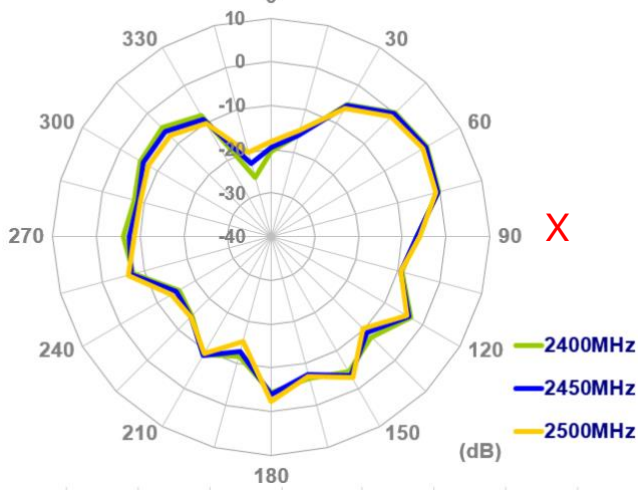


### 4.8 2D Radiation Pattern (Bent position with 30\*30cm ground plane center)

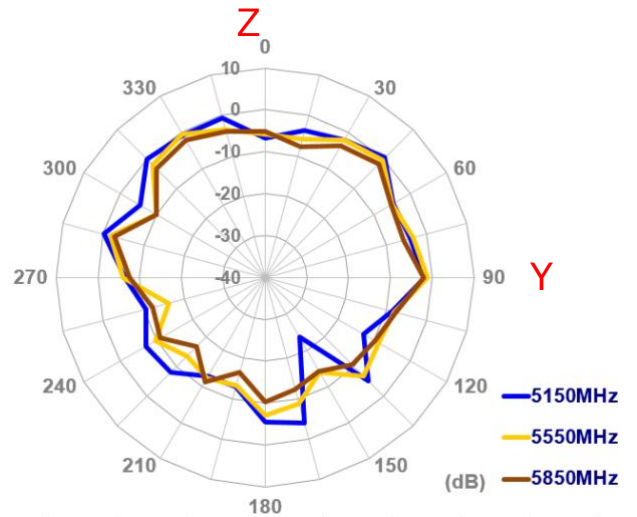
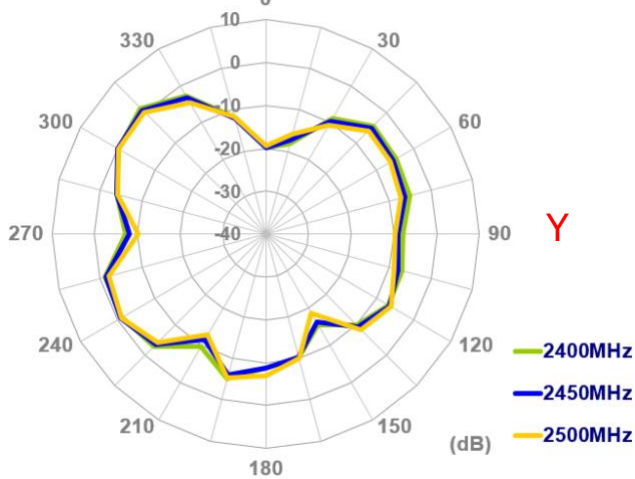
XY Plane **X**



XZ Plane **Z**

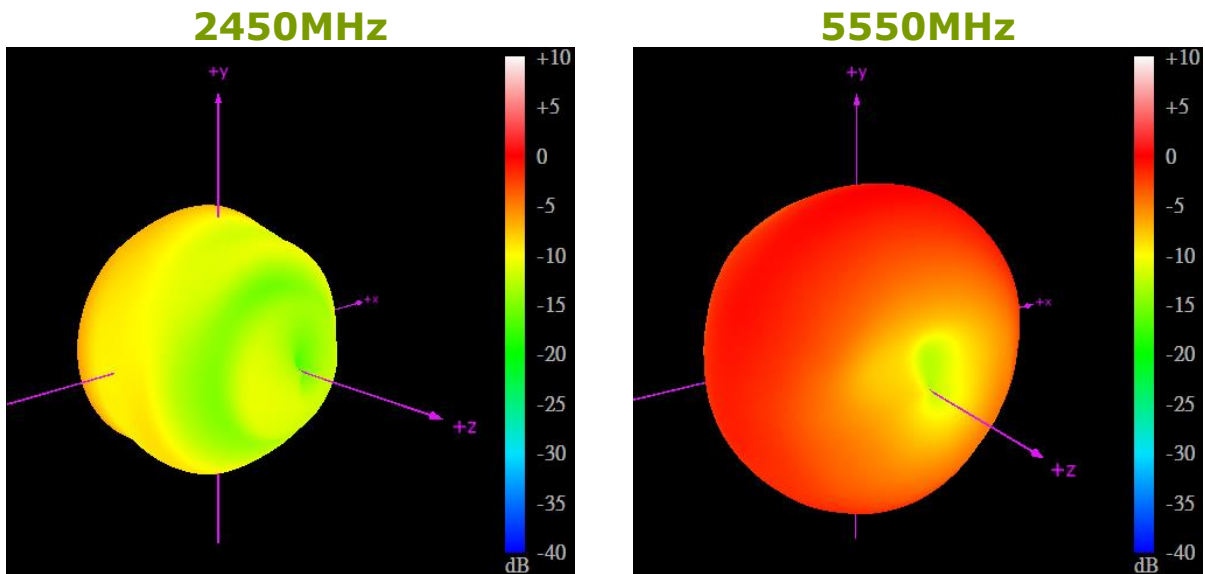


YZ Plane **Z**

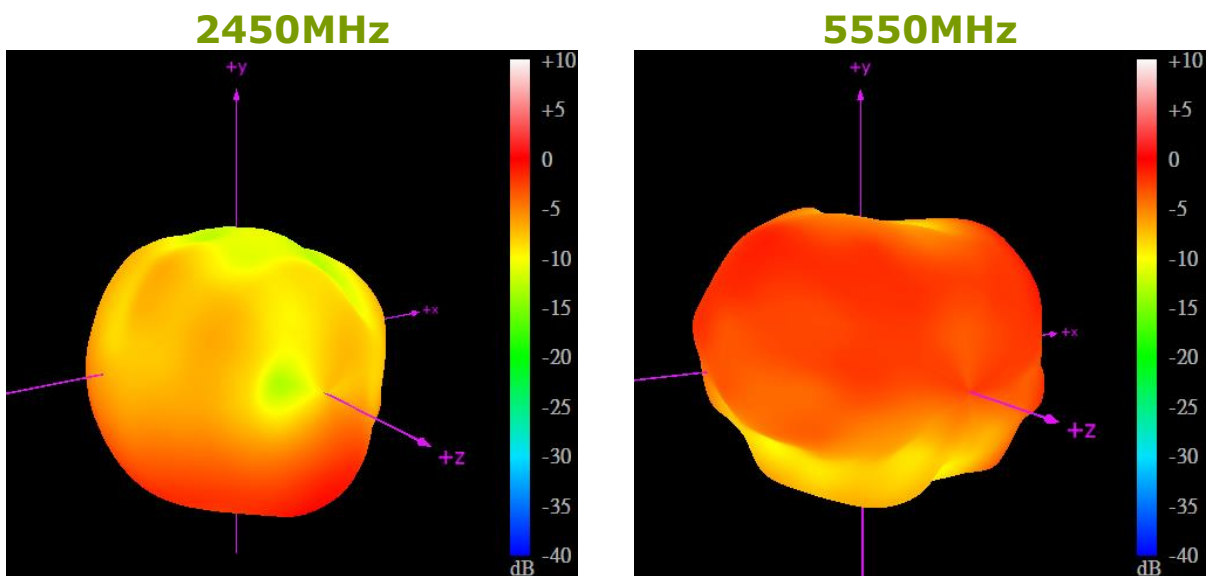




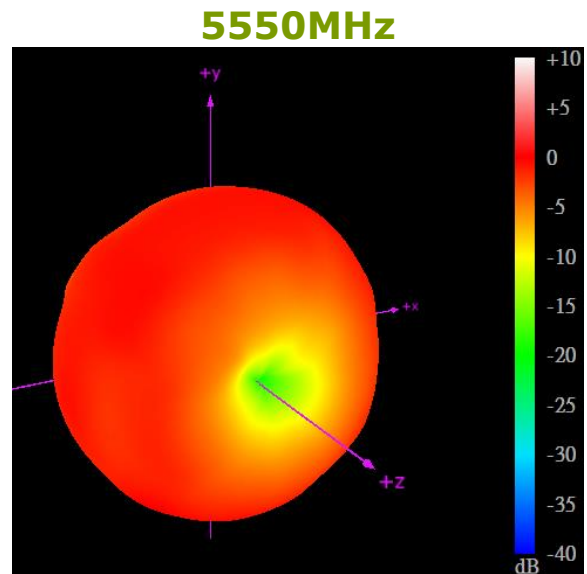
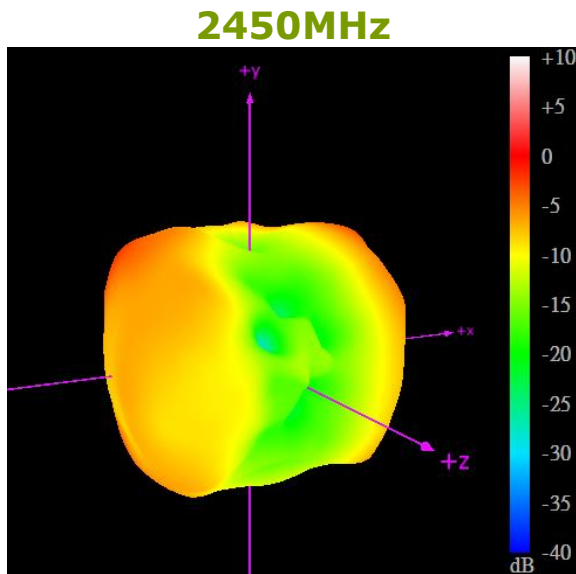
### 4.9 3D Radiation Pattern (Straight position in free space)



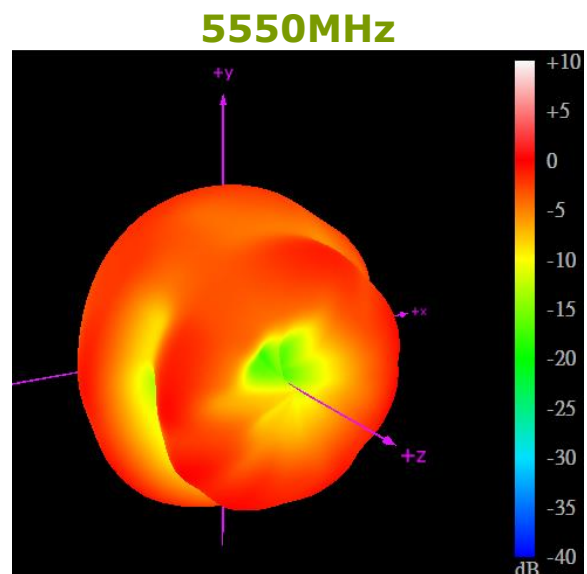
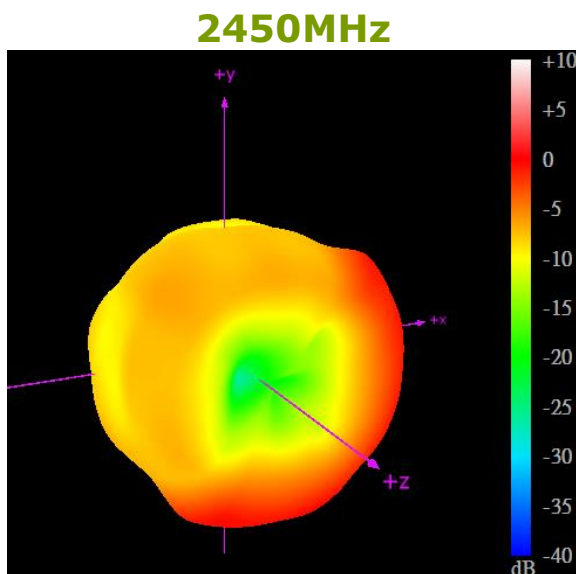
### 4.10 3D Radiation Pattern (Straight position with 15x9cm ground plane)



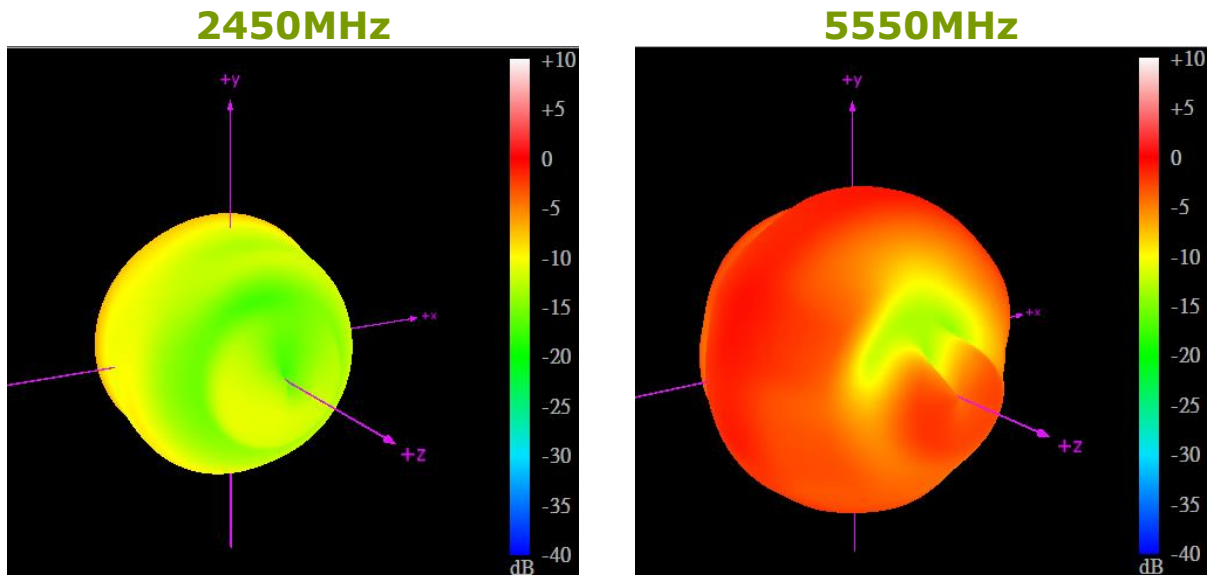
**4.11 3D Radiation Pattern (Straight position with 30x30cm ground plane edge)**



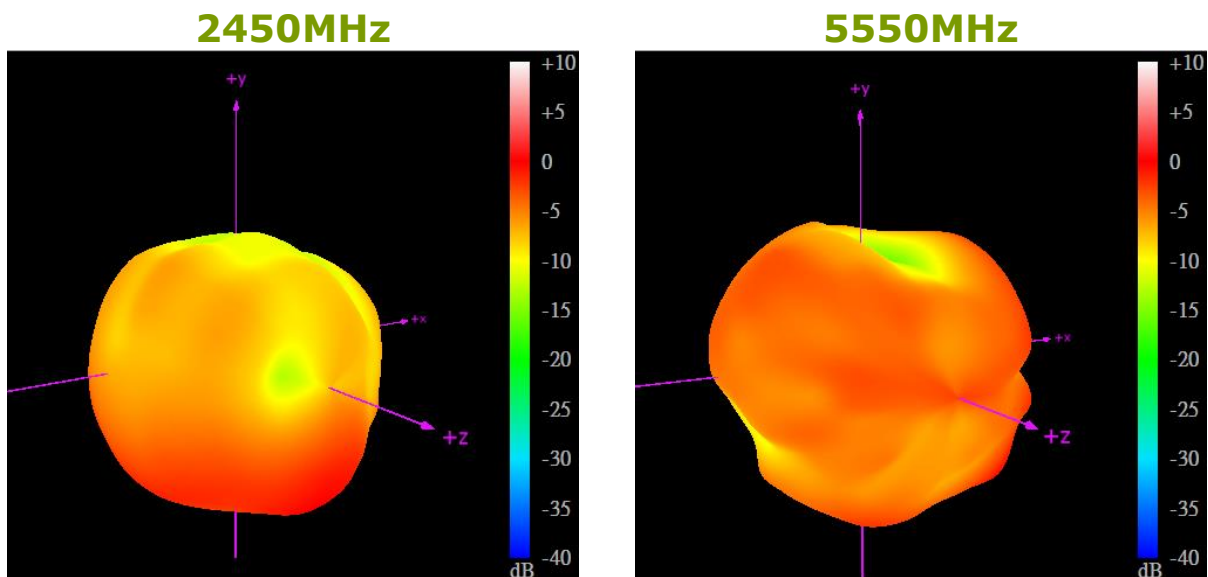
**4.12 3D Radiation Pattern (Straight position with 30x30cm ground plane center)**



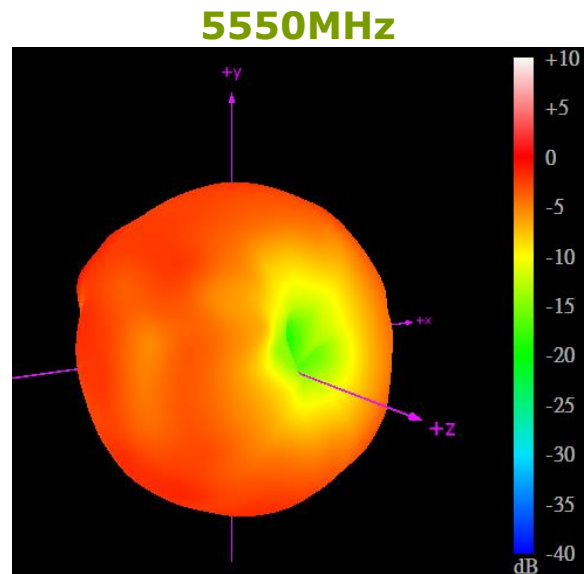
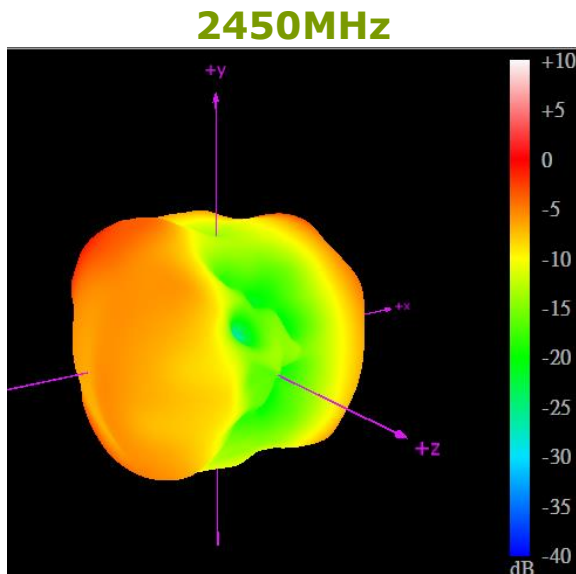
### 4.13 3D Radiation Pattern (Bent position in free space)



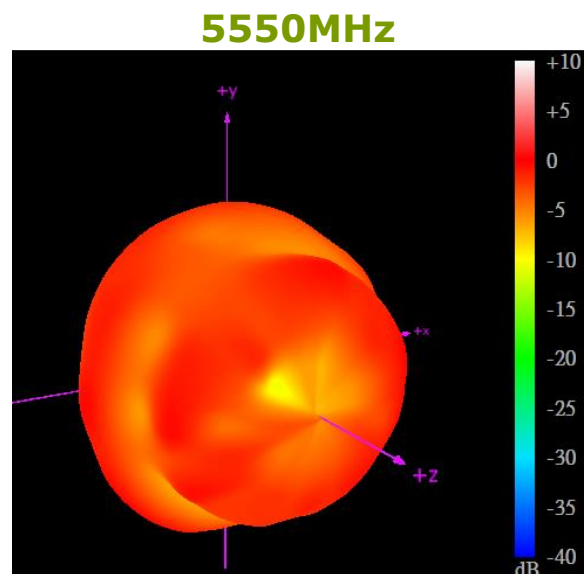
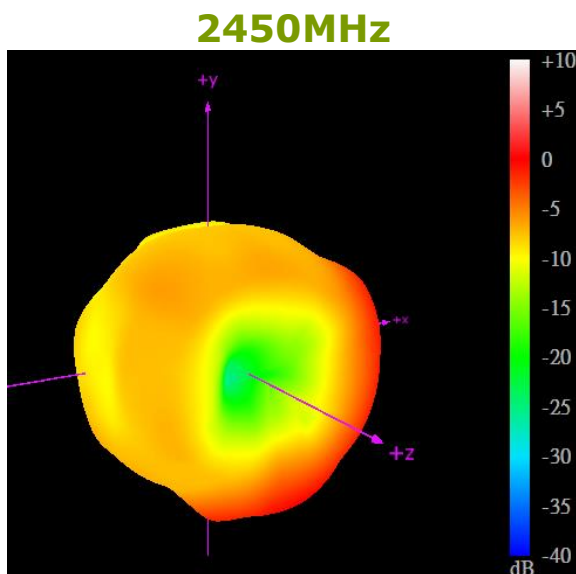
### 4.14 3D Radiation Pattern (Bent position with 15x9cm ground plane)



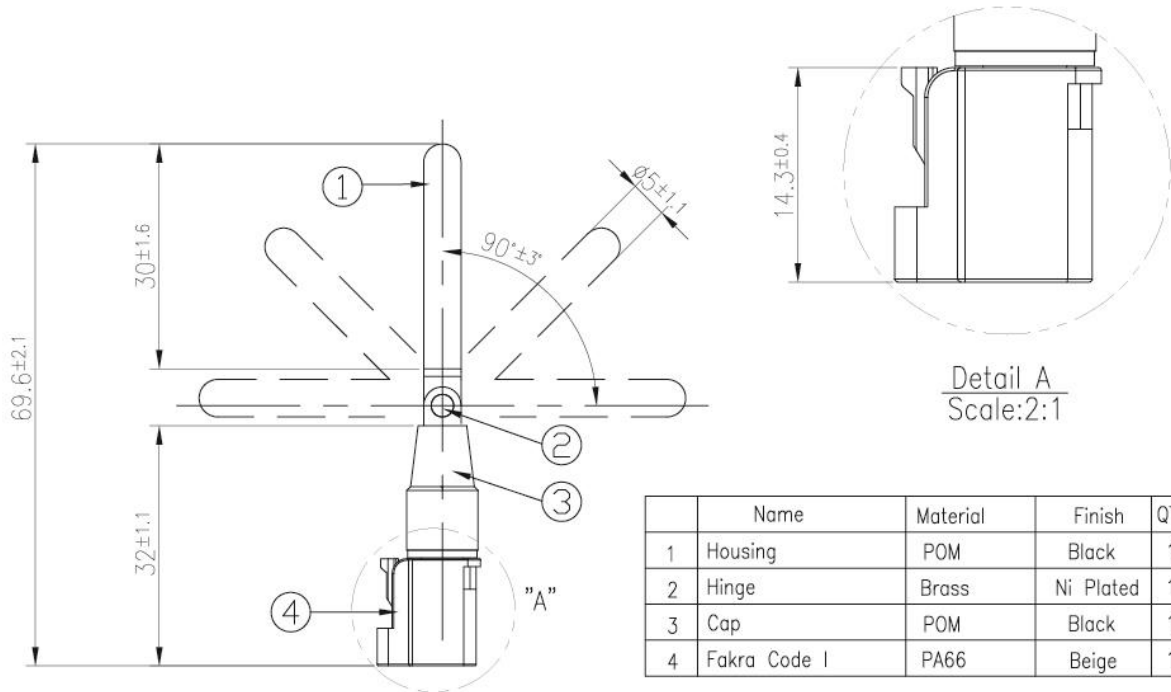
**4.15 3D Radiation Pattern (Bent position with 30x30cm ground plane edge)**



**4.16 3D Radiation Pattern (Bent position with 30x30cm ground plane center)**



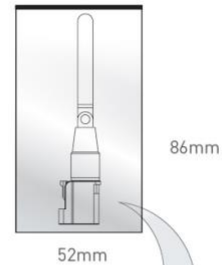
## 5. Mechanical Drawing (Unit:mm)



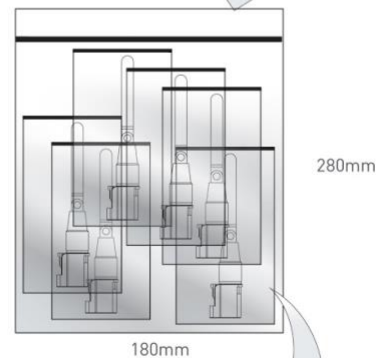


## 6. Packaging

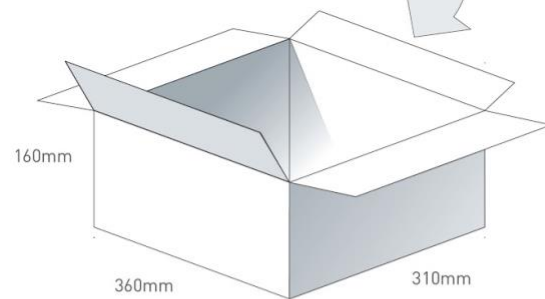
1pc GW.05.0E23 per small PE bag  
 Bag Dimensions - 86\*52 mm  
 Weight - 8.5g



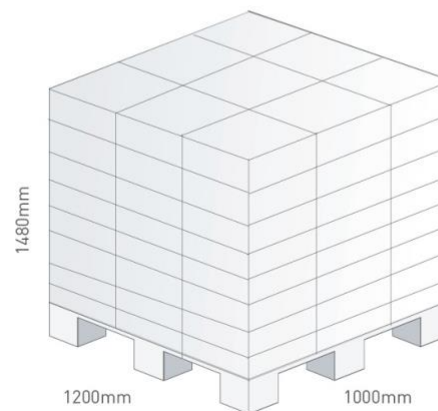
100pcs GW.05.0E23 per large PE bag  
 Bag Dimensions - 280\*180 mm  
 Weight - 0.85Kg



1000pcs GW.05.0E23 per carton  
 Carton Dimensions - 360\*310\*160mm  
 Weight - 9Kg



Pallet Dimensions 1200mm\*1000mm\*1480mm  
 72 Cartons per Pallet  
 9 Cartons per layer  
 8 Layers



Taoglas makes no warranties based on the accuracy or completeness of the contents of this document and reserves the right to make changes to specifications and product descriptions at any time without notice. Taoglas reserves all rights to this document and the information contained herein.

Reproduction, use or disclosure to third parties without express permission is strictly prohibited.

© Taoglas