

[TABLE] (B1)

MATERIAL NO.	DIMENSION			MATERIAL
	A	B	C	
355060510	29.5	28.5	23.0	POLYESTER
355060519	30.2	28.9	23.4	PET/PC

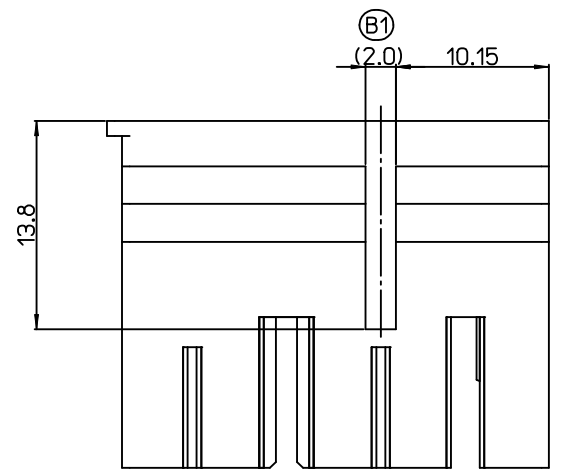
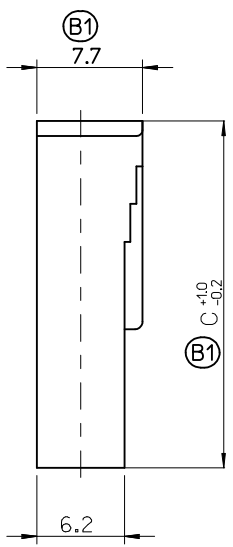
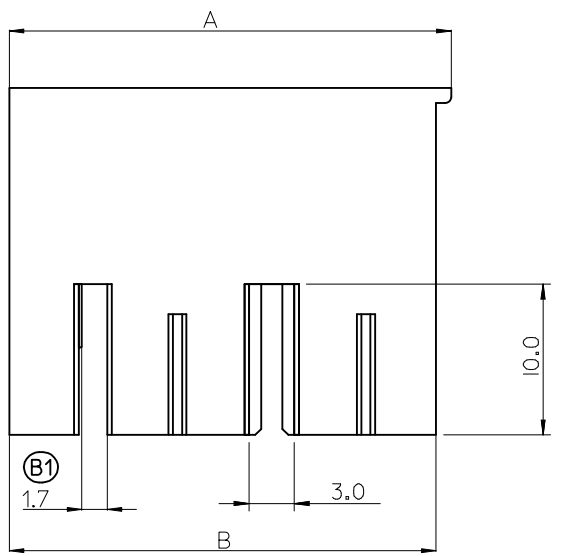
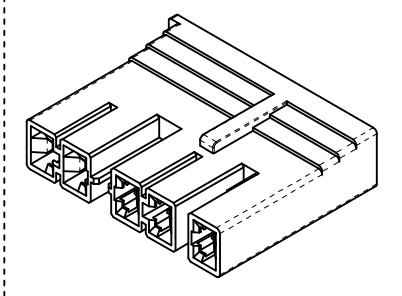

NOTES

- MATERIAL :
 - ① 35506-0510 : POLYESTER(PBT), NO GLASS FILLED, UL94V-0 COLOR : NATURAL
 - (B1) ② 35506-0519 : PET/PC, NO GLASS FILLED, UL94V-0 COLOR : NATURAL
- PRODUCT SPECIFICATION : PS-35506-001
- PACKING SPECIFICATION : PK-35506-001
- APPLICABLE TERMINAL : 35097-9*12

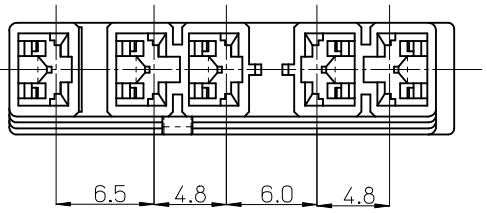

PRELIMINARY REVISED
 IEC NO: KOR2013-0051
 DRWN: JSSHIN 2012/12/18
 CH'KD: SHCHU 2012/12/18
 APPR: YSKIM02 2012/12/27

QUALITY SYMBOLS
 ▽=0
 ∇=0

GENERAL TOLERANCES (UNLESS SPECIFIED)

	mm	INCH
4 PLACES	± ---	± ---
3 PLACES	± ---	± ---
2 PLACES	± 0.30	± ---
1 PLACE	± 0.30	± ---
0 PLACE	± ---	± ---

ANGULAR ± 3 °
 DRAFT WHERE APPLICABLE MUST REMAIN WITHIN DIMENSIONS

DIMENSION STYLE
MM ONLY

DRAWN BY: WY.YANG
 DATE: 1996/06/17

CHECKED BY: BK.CHOI
 DATE: 1996/06/17

APPROVED BY: YSKIM02
 DATE: 2012/12/27

MATERIAL NO. SEE TABLE

SCALE 3:1
 DESIGN UNITS METRIC
 THIRD ANGLE PROJECTION

TITLE
 .110 MP-LOCK HOUSING -5P (FOR DOOR SWITCH)

molex

DOCUMENT NO. SD-35506-001
 SHEET NO. 1 OF 1

THIS DRAWING CONTAINS INFORMATION THAT IS PROPRIETARY TO MOLEX INCORPORATED AND SHOULD NOT BE USED WITHOUT WRITTEN PERMISSION

TERMINAL PATTERN

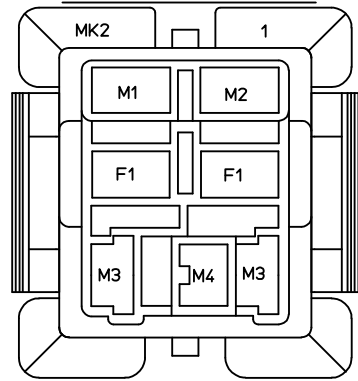

- M1 TERMINAL : 35453-9*02
- M2 TERMINAL : 35452-9*02
- M3 TERMINAL : 35725-1810/1910/3010
- M4 TERMINAL : 35765-0110/0210
- F1 TERMINAL : 35725-5*10
- M = MALE TERMINAL
- F = FEMALE TERMINAL

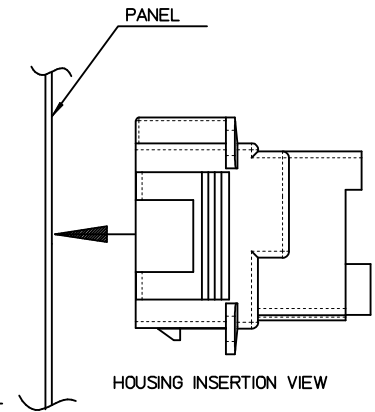
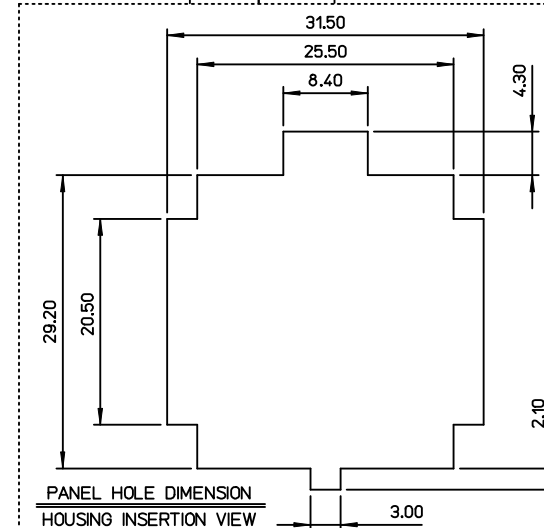
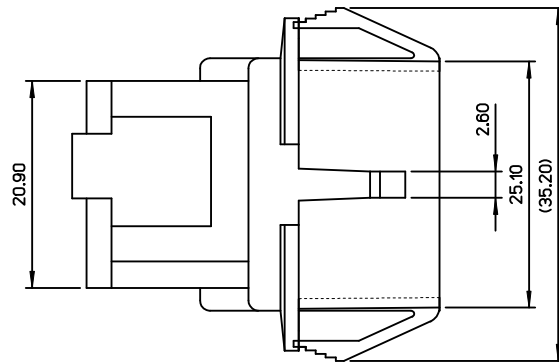
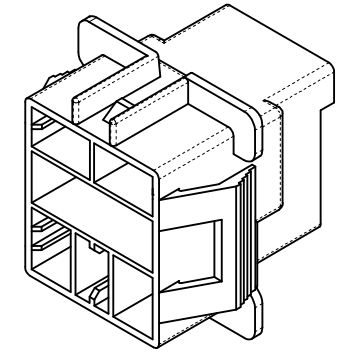
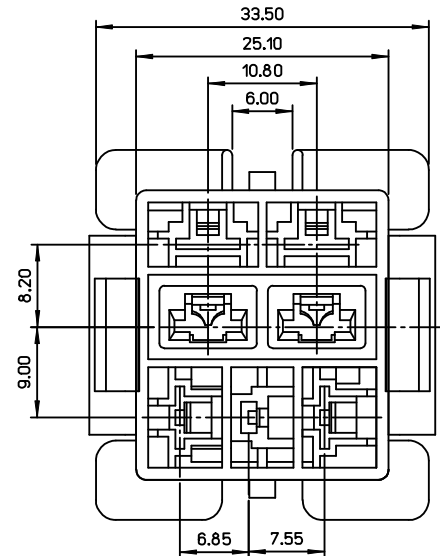
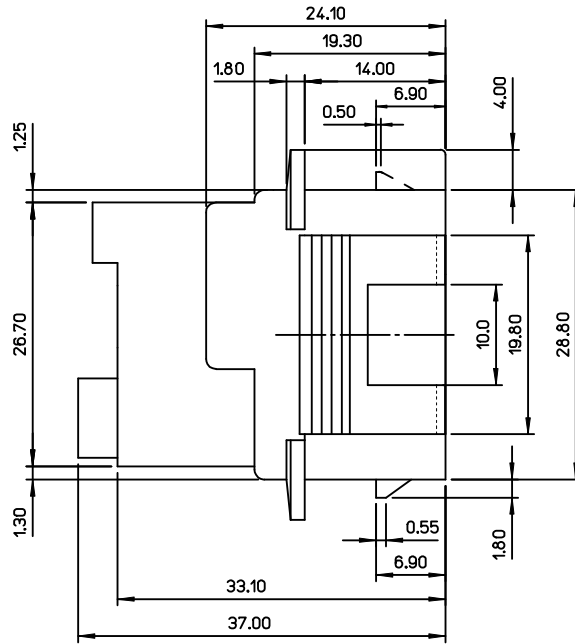

NOTES

1. MATERIAL : PET/PC, NO GLASS FILLED, UL94V-0; COLOR : NATURAL
2. PRODUCT SPECIFICATION : PS-35546-001
3. PACKING SPECIFICATION : PK-35546-001
4. MATED HOUSING : 35547-0309
35547-0409

REVISED	IEC NO: KOR2015-0152	2015/06/23	QUALITY SYMBOLS
	DRWN: SCHONG03	2015/06/23	
	CHKD: SHCHU	2015/06/23	
	APPR: YSKIM02	2015/06/30	
REV	DESCRIPTION		

GENERAL TOLERANCES (UNLESS SPECIFIED)	mm	INCH	
	4 PLACES	± ---	± ---
	3 PLACES	± ---	± ---
	2 PLACES	± 0.30	± ---
	1 PLACE	± 0.30	± ---
	0 PLACE	± ---	± ---
ANGULAR ± 3 °			
DRAFT WHERE APPLICABLE MUST REMAIN WITHIN DIMENSIONS			

DIMENSION STYLE		SCALE	DESIGN UNITS	THIRD ANGLE PROJECTION
MM ONLY		2:1	METRIC	
DRAWN BY	DATE	TITLE		
JB. JIN	2012/10/25	.250 MULTI W-T-W CONN. RECEPTACLE HOUSING 7P (FOR GWIT)		
CHECKED BY	DATE			
SH. CHU	2012/10/25			
APPROVED BY	DATE			
YSKIM02	2012/12/27			
MATERIAL NO.				
355460709		SD-35546-003	1 OF 1	

THIS DRAWING CONTAINS INFORMATION THAT IS PROPRIETARY TO MOLEX INCORPORATED AND SHOULD NOT BE USED WITHOUT WRITTEN PERMISSION