



650V/ 15A Silicon Carbide Power Schottky Barrier Diode

Features

- Zero reverse recovery current
- Zero forward recovery voltage
- Temperature independent switching behavior
- High temperature operation
- High frequency operation

Benefits

- Unipolar rectifier
- Substantially reduced switching losses
- No thermal run-away with parallel devices
- Reduced heat sink requirements

Applications

- SMPS, e.g., CCM PFC;
- Motor drives, Solar application, UPS, Wind turbine, Rail traction, EV/HEV

Key Characteristics		
V_{RRM}	650	V
$I_F, T_c \leq 143^\circ\text{C}$	15	A
Q_c	31	nC

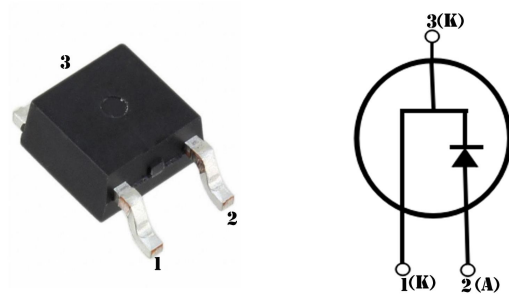

Part No.	Package Type	Marking
G4S06515CT	TO-252	G4S06515CT

Maximum Ratings

Parameter	Symbol	Test Condition	Value	Unit
Repetitive Peak Reverse Voltage	V_{RRM}		650	V
Surge Peak Reverse Voltage	V_{RSM}		650	V
DC Blocking Voltage	V_{DC}		650	V
Continuous Forward Current	I_F	$T_C=25^{\circ}C$ $T_C=125^{\circ}C$ $T_C=143^{\circ}C$	35.8 18.9 15	A
Repetitive Peak Forward Surge Current	I_{FRM}	$T_C=25^{\circ}C$, $t_p=10ms$, Half Sine Wave, $D=0.3$	50	A
Non-repetitive Peak Forward Surge Current	I_{FSM}	$T_C=25^{\circ}C$, $t_p=10ms$, Half Sine Wave	130	A
Power Dissipation	P_{TOT}	$T_C=25^{\circ}C$	128	W
		$T_C=110^{\circ}C$	56	W
Operating Junction	T_j		-55°C to 175°C	°C
Storage Temperature	T_{stg}		-55°C to 175°C	°C

Thermal Characteristics

Parameter	Symbol	Test Condition	Value	Unit
			Typ.	
Thermal resistance from junction to case	R_{thJC}		1.17	°C/W

Electrical Characteristics

Parameter	Symbol	Test Conditions	Numerical		Unit
			Typ.	Max.	
Forward Voltage	V_F	$I_F=15A, T_j=25^\circ C$	1.5	1.7	V
		$I_F=15A, T_j=175^\circ C$	2	2.5	
Reverse Current	I_R	$V_R=650V, T_j=25^\circ C$	0.5	50	μA
		$V_R=650V, T_j=175^\circ C$	1.4	100	
Total Capacitive Charge	Q_C	$V_R=400V, T_j=150^\circ C$ $Q_C = \int_0^{V_R} C(V)dV$	31	-	nC
Total Capacitance	C	$V_R=0V, T_j=25^\circ C, f=1MHz$	645	680	pF
		$V_R=200V, T_j=25^\circ C, f=1MHz$	58	61	
		$V_R=400V, T_j=25^\circ C, f=1MHz$	56	58	

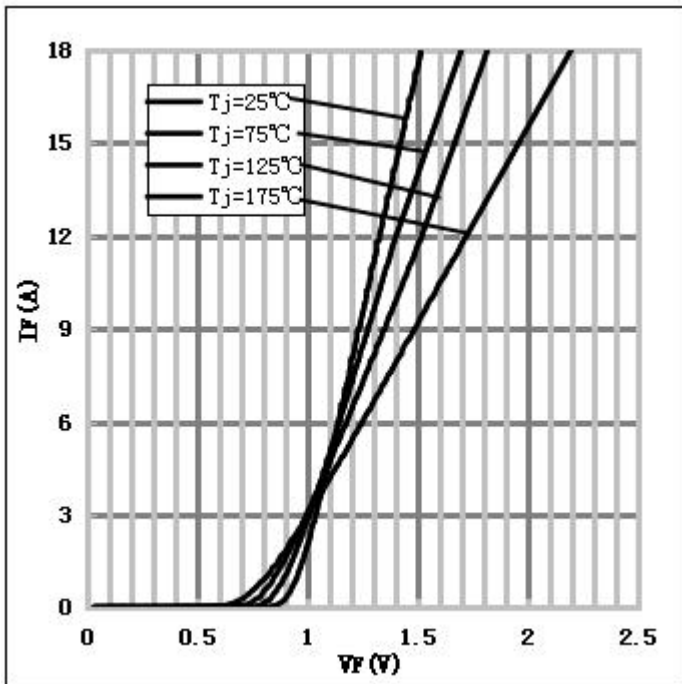
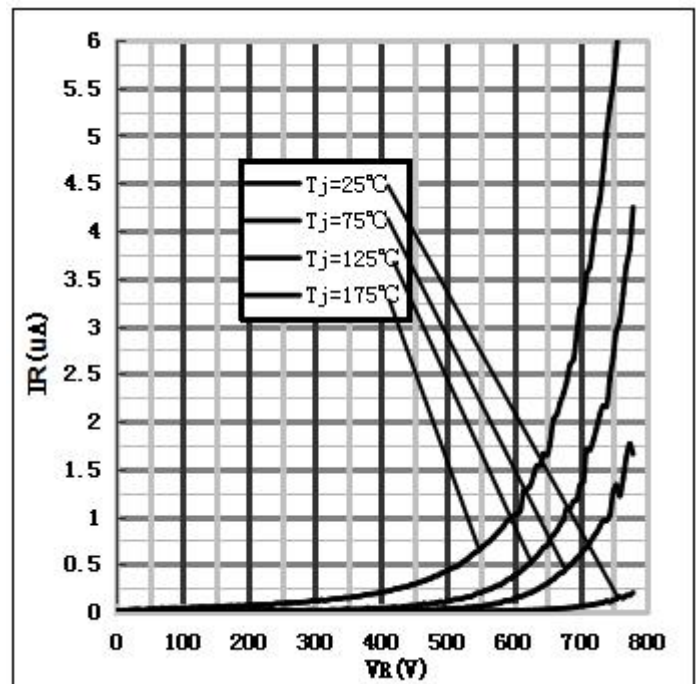
Performance Graphs1) Forward IV characteristics as a function of T_j :2) Reverse IV characteristics as a function of T_j :

3) Current Derating:

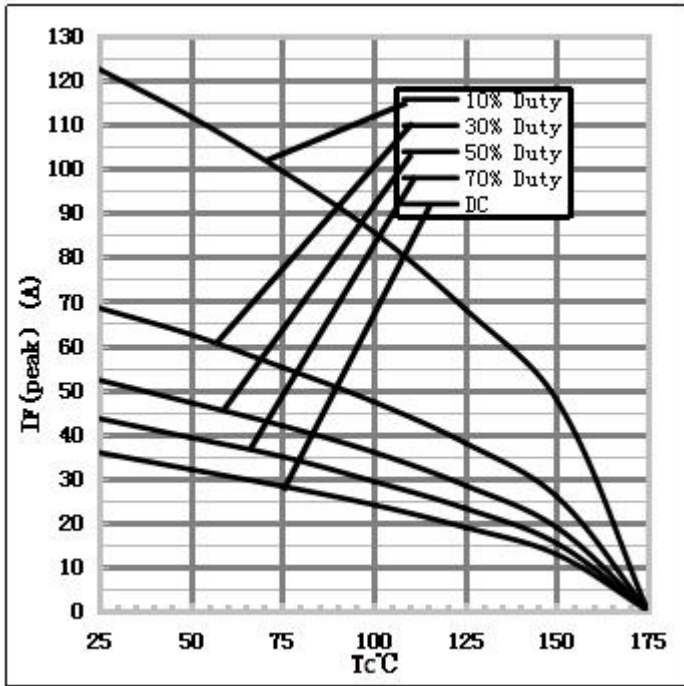

4) Capacitance vs. reverse voltage:

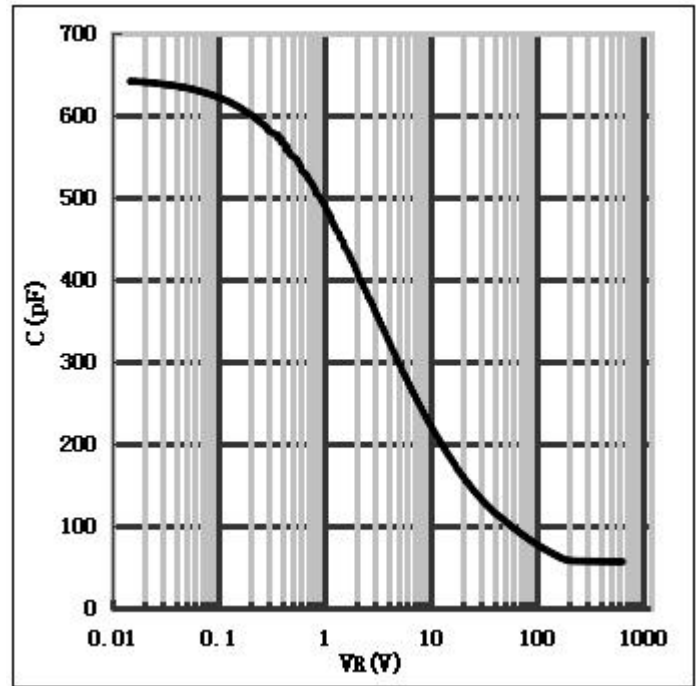

Package TO-252

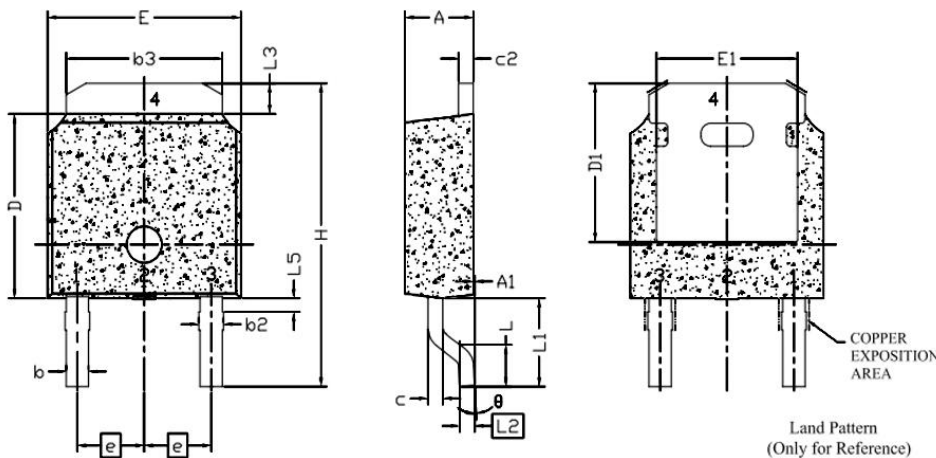

SYMBDL	DIMENSIONAL REQMT'S		
	MIN	NOM	MAX
E	6.40	6.60	6.731
L	1.40	1.52	1.77
L1	2.743 REF		
L2	0.508 BSC		
L3	0.89	--	1.27
L5	--	--	--
D	6.00	6.10	6.22
H	9.40	10.00	10.40
b	0.64	0.76	0.88
b2	0.77	0.84	1.14
b3	5.21	5.34	5.46
e	2.286 BSC		
A	2.20	2.30	2.38
A1	0	--	0.127
C	0.46	0.50	0.60
C2	0.46	0.50	0.58
D1	5.21	--	--
E1	4.40	--	--
theta	0°	--	10°

Note:

1. All Dimension Are In mm.
2. Package Body Sizes Exclude Mold Flash, Protrusion Or Gate Burrs. Mold Flash, Protrusion Or Gate Burrs Shall Not Exceed 0.10 mm Per Side.
3. Package Body Sizes Determined At The Outermost Extremes Of The Plastic Body Exclusive Of Mold Flash, Gate Burrs And Interlead Flash, But Including Any Mismatch Between The Top And Bottom Of The Plastic Body.
4. The Package Top May Be Smaller Than The Package Bottom.
5. Dimension "b" Does Not Include Dambar Protrusion. Allowable Dambar Protrusion Shall Be 0.10 mm Total In Excess Of "b" Dimension At Maximum Material Condition. The Dambar Cannot Be Located On The Lower Radius Of The Foot.

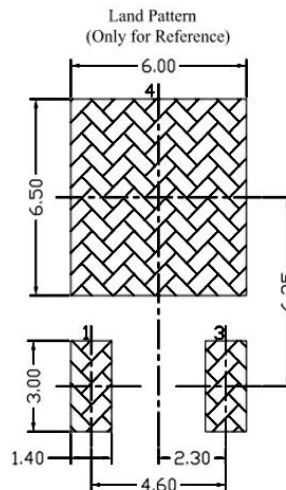

Note: The levels of RoHS restricted materials in this product are below the maximum concentration values (also referred to as the threshold limits) permitted for such substances, or are used in an exempted application, in accordance with EU Directive 2011/65/EC(RoHS2). RoHS Certification and other certifications can be obtained from GPT sales representatives or GPT website: <http://globalpowertech.cn/English/index.asp>

More product datasheets and company information can be found in:

<http://globalpowertech.cn/English/index.asp>

